

Review

National Deployment of Domestic Geothermal Heat Pump Technology: Observations on the UK Experience 1995–2013

Simon Rees ^{1,*} and Robin Curtis ²

¹ Institute of Energy and Sustainable Development, De Montfort University, The Gateway, Leicester LE1 9BH, UK

² GeoScience Ltd., Falmouth Business Park, Bickland Water Rd., Falmouth TR11 4SZ, UK; E-Mail: curtis@geoscience.co.uk

* Author to whom correspondence should be addressed; E-Mail: sjrees@dmu.ac.uk; Tel.: +44-(0)116-257-7974; Fax: +44-(0)116-257-7981.

Received: 25 June 2014; in revised form: 31 June 2014 / Accepted: 13 August 2014 /

Published: 22 August 2014

Abstract: Uptake of geothermal heat pump technology in the UK and corresponding development of a domestic installation industry has progressed significantly in the last decade. This paper summarizes the growth process and reviews the research that has been specifically concerned with conditions in the UK. We discuss the driving forces behind these developments and some of the supporting policy initiatives that have been implemented. Publically funded national trials were completed to assess the performance and acceptance of the technology and validate design and installation standards. We comment on both the technical and non-technical findings of the trials and the related academic research and their relevance to standards development. A number of technical issues can be identified—some of which may be particular to the UK—and we suggest a number of research and development questions that need to be addressed further. Current national support for the technology relies solely on a tariff mechanism and it is uncertain that this will be effective enough to ensure sufficient growth to meet the national renewable heat target in 2020. A broader package of support that includes mandatory measures applied to future housing development and retrofit may be necessary to ensure long-term plans for national deployment and decarbonization of heat are achieved. Industry needs to demonstrate that efficiency standards can be assured, capital costs reduced in the medium-term and that national training schemes are effective.

Keywords: geothermal heat pump; trials; monitoring; standards; incentives

1. Introduction

Exploitation of geothermal energy at shallow depths (<500 m) by the application of heat pump technology has grown rapidly in a number of countries since the 1990s so that more than 2.7 million world-wide installations have been reported [1]. The most common form of geothermal or ground-source heat pump (GSHP) technology uses anti-freeze fluid circulated in a closed loop heat exchanger and the vapor-compression refrigeration cycle to deliver thermal energy for space heating and hot water production. In the UK, the form of closed loop heat exchanger used in domestic systems is usually a single U-tube vertical borehole (up to 100 m deep), horizontal parallel loop or horizontal “slinky” device (1–2 m deep). Space heating in UK domestic properties using this technology is nearly always hydronic with heat emitters that are radiator/convectors or under-floor heating and domestic hot water production is often supplemented by electric resistance heating.

The diffusion of geothermal heat pump technology into the UK domestic building market has lagged that found in several northern European and North American countries by more than a decade. The national scene has changed from only a few installations known in the 1990s to several thousand being installed annually and a young installation industry being established. Domestic geothermal heat pumps now feature in the government’s national carbon reduction strategies, renewable energy production targets and related market incentive schemes. These developments have been accompanied by national field trials to support technical evaluation and standards development. A national industry body has been established that promotes the technology and provides support for training and standards development. Although early diffusion of the technology has been arguably successful, the UK GSHP industry has recently faced very challenging economic circumstances and changing regulatory and market incentive frameworks.

In this paper, we review the time-line of the deployment of geothermal heat pump technology in the UK domestic market and attempt to identify some of the key growth factors. Three phases of national field trials of the technology and both the technical and socio-technological conclusions that have been drawn are summarized. We furthermore identify a number of technical issues that may be particular to the UK situation that would benefit from further research. We finally reflect on the recent changes in policy and the regulatory framework and prospects for further market growth.

1.1. The National Context

Understanding of the apparently reluctant uptake of geothermal heat pump systems in the UK requires some appreciation of the technological context and the national energy scene. The UK has a maritime climate such that winter temperatures are mild compared to Scandinavian and Central European climates and moderate in summer such that domestic cooling is unnecessary. The mild climate and abundance of fossil fuels has meant that relatively poor insulation and airtightness standards have been tolerated and are reflected in much of the historic building stock. The predominant domestic heating technology is natural gas fueled hydronic heating (more than one million gas boilers

are sold each year). This predominance is a natural reflection of the abundance of natural gas resources available in the last few decades and a well-developed gas distribution network. Mains gas heating is used in 84.2% of households with 9% using electric heating (1.9 million households). The third most common fuel is heating oil which is used in 3.9% of all households and is much more common in rural areas [2]. Fuels such as LPG, biomass and coal are currently used only in small quantities. Hydronic heating systems are typically designed for high temperature operation with wall mounted radiator heat emitters. Under-floor heating is not common, even in new housing.

The predominance of hydronic heating systems using natural gas boilers is also reflected in the national skills and knowledge base. The absence of demand for domestic air conditioning has meant that skills and training in small-scale refrigeration systems is very limited. This is similarly reflected in the education and training that has been demanded by, and delivered to, the domestic heating industry.

This historic abundance of coal resources, and more recently natural gas, has meant that much of the UK electrical energy supply is derived from fossil fuel sources. Only approximately 20% of power is generated by nuclear sources and the renewable contribution has been insignificant until very recently. This has meant that the carbon emissions associated with electrical energy are relatively high compared with other energy sources. Consequently, although the carbon emissions reduction benefits of using geothermal heat pumps can be demonstrated, these benefits are more marginal than in some other countries [3]. A technical feature of the national electrical power distribution system is that domestic buildings have single-phase supplies that have limited ability to tolerate compressor start-up currents [4]. This has placed a limit of approximately 8–12 kW on the maximum capacity of most domestic heat pump systems in the existing housing stock.

The broad situation regarding accepted technologies, skills base, and energy supply can be contrasted with that in a number of other countries that have demonstrated significant uptake of geothermal heat pump technology. In the USA, for example, the prevalence of domestic air conditioning means that there is a good refrigeration skills base and consumers are willing to accept central air systems with little difficulty. In many parts of the USA there are also established land drilling industries able to offer geothermal borehole drilling at acceptable cost. In countries such as Sweden, Austria and Switzerland, more prevalent hydro electricity generation makes electric heating more economic and also advantageous in terms of carbon emissions compared to fossil fuels than in the UK. The mild climate in the UK also means that the efficiency advantages of geothermal heat pumps are not as great compared to air-source heat pumps (ASHP) as in countries with more severe winters such as those in Central Europe, Canada and Sweden.

1.2. Market Development

Worldwide surveys of geothermal heat pump developments have been reported at five-year intervals since 1975 (e.g., [5]) and have included reports from the UK since 1985 [6]. Although such international data highlights significant growth in application of heat pumps to domestic buildings in the 1990s in several parts of Europe and the USA, little activity was reported for the UK in early surveys. Although there is evidence of the application of domestic ground source heat pumps in the UK since 1960 [7], it is thought that the first system of what may now be considered conventional, borehole based, closed-loop configuration was installed in 1994 [8]. A total of 40 UK installations

were reported in 2000 in contrast to an estimated 500,000 installations worldwide and a growth of 59% in terms of global installed capacity in the 1995–2000 period [9].

It is not until the first decade of the current century that developments beyond single properties and establishment of viable installation industry in the UK can be identified. In 2005 [5] it was reported that, “the country now understands that ground-source heat pumps, connected to the electricity grid, offer very substantial reductions in overall carbon emissions compared to conventional fossil-fueled systems”. It was also reported that approximately 500 domestic systems were known [10] and estimated to have a combined capacity of 10.2MWt and an annual energy use of 45.6 TJ/year. The 2000–2005 period, therefore, represents a significant change in the deployment of geothermal heat pump technology in the UK.

Geothermal heat pump market data reporting annual sales in the UK has been available since 2007 [11] and reflects annual installations at a rate of 2400 in that year rising to 3980 in 2009. Similar installation rates were reported in the international survey published in 2010 [1]. Data for 2012/2013 indicates installation rates have fallen to approximately 3000 per annum following the broader downturn in the economy. Following the introduction of the EU Renewable Energy Sources directive, cumulative data reporting the uptake of geothermal heat pump technology along with estimates of thermal energy production within EU Member states has been recorded by EurObserv'ER [12,13]. These data, in the case of the UK submissions, are based on market reports and so included a figure of 3980 annual installations in 2009 [12] and an estimated cumulative uptake of 14,330 systems. This cumulative figure had risen to 17,760 in 2012 [13]. The latter data is consistent with the figure of approximately 16,000 being installed by the end of 2012 reported to the European Geothermal Energy Congress [14]. Installations were projected to grow by a further 3000 in 2013 [11].

Figure 1. (a) Total geothermal heat pump installations in the UK ranked with other EU Member States as of 2012; (b) total installations per million capita. Data from [12,13].

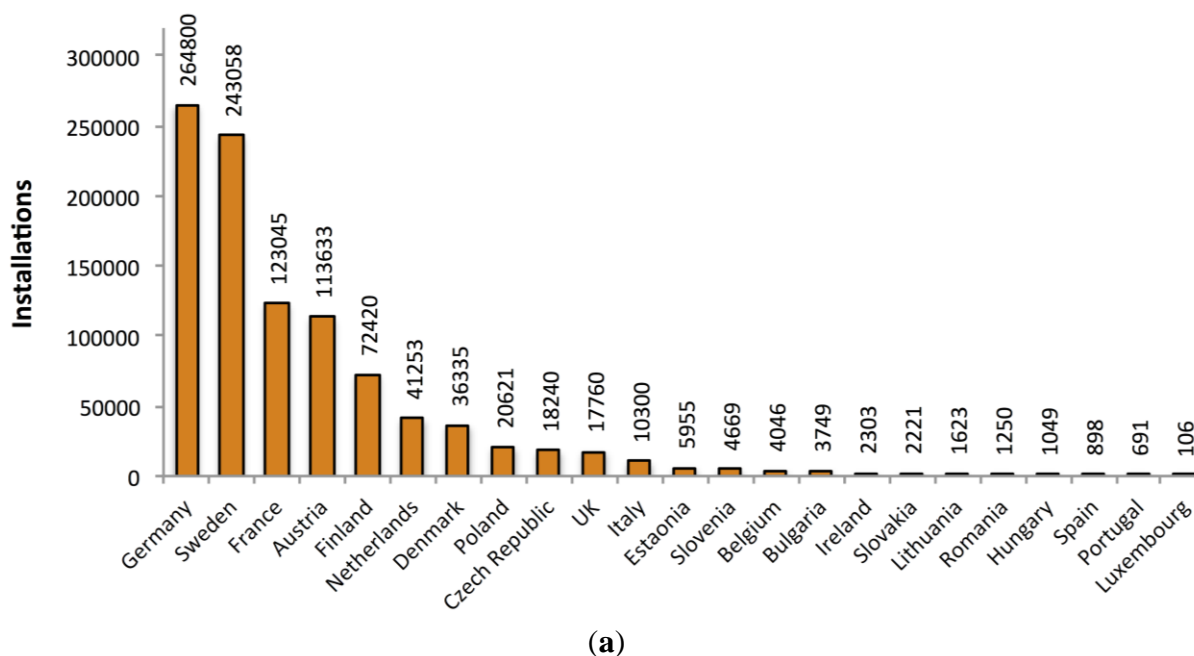
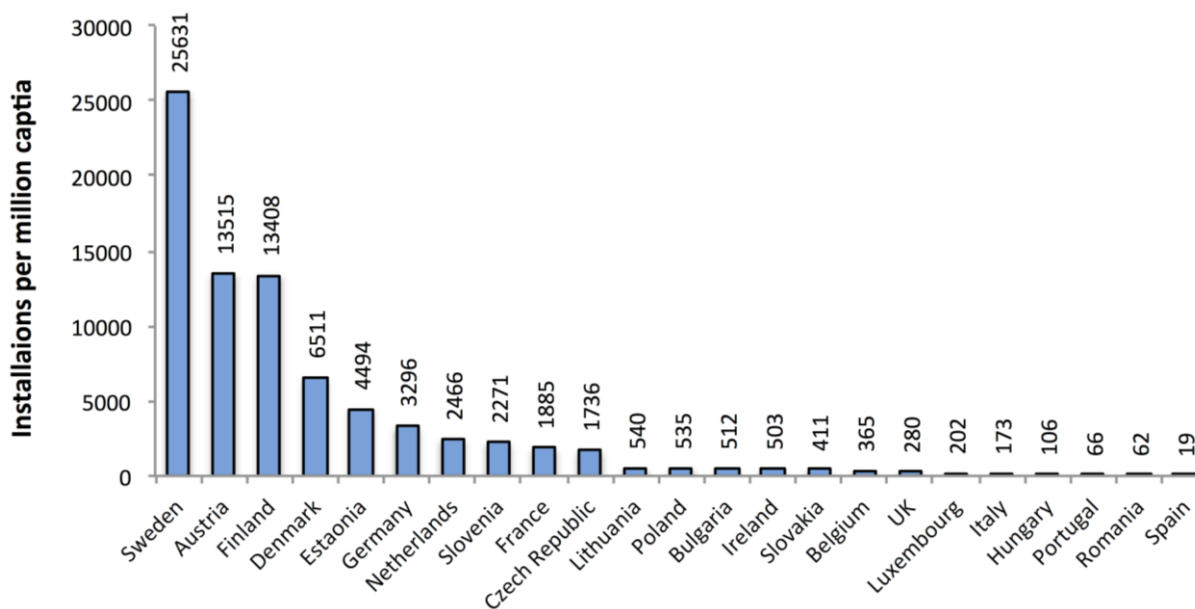

Figure 1. Cont.



(b)

These data have been put into a European context in Figure 1 along with data formulated on a per capita basis. The significant deployment of the technology in Sweden, Germany and Austria has been demonstrated for some time and is unsurprising [1,15,16]. Uptake in France has been rapid in recent years [17]. The data shown in Figure 1 suggests that the UK installation industry is in the early stages of growth but small relative to other EU Member States. Penetration into the domestic heating market is broadly demonstrated by the data compared on a per-capita basis (Figure 1b). Although these data suggest penetration is currently poor in the UK, comparison with smaller countries but with similar climates (Netherlands and Denmark) suggests there is considerable potential for further growth.

1.3. Policy and Support Programme Development

1.3.1. Capital Grant Programmes

The development of UK energy efficiency policy can be traced from the oil crisis of 1973 and has varied in its emphasis on interventionist or market led measures through several governments of differing political persuasion [18]. It is not until the 1990s that carbon emissions reduction is explicitly addressed in policy documents [19] and even more recently that renewable energy policy and support programmes have emerged. The move towards an integrated approach to significant carbon emissions reduction that embraces energy efficiency and renewable energy is most clearly marked by the policy statements in the 2002 Energy Review [20] and the legislation in the 2003 Energy White Paper “Our Energy Future—Creating a Low Carbon Economy” [21]. These policy statements also sought to address the issues of energy security and fuel poverty and placed a noticeable emphasis on community scale measures. One of the first actions arising from the Energy Review was the release of £100 million for renewable energy support of which £31 million went into a PV demonstration programme, £10 million into the “Clear Skies” programme and £3.1 million into the corresponding

‘Scottish Community and Householders Renewables Initiative’ (SCHRI) to support small-scale renewable energy schemes.

The Clear Skies programme [22] offered capital grant support for a range of small-scale “microgeneration technologies” that included many recognized renewable technologies. In the few years leading up to the development stage of the Clear Skies programme (during planning in 2002 it had been known as the “Community and Household Capital Grant Scheme”) there was both inter-departmental debate and external consultation as to what technologies might be classified as “microgeneration” and furthermore receive grants. Geothermal heat pumps were incorporated into the definition of microgeneration technologies but not without presentation of the case for support from industry stakeholders. It proved valuable to be able to point to some of the early UK examples that had shown promising levels of performance (e.g., [23]) as well as a larger body of international good practice (e.g., [24]). The argument that geothermal heat pumps could, in the long run, make significant contributions to carbon reduction—given minimum performance levels and also in view of long-term plans for decarbonization of the grid—was accepted. The technologies supported by the Clear Skies programme were then: solar thermal, micro-wind, small-scale hydro, biomass boilers and geothermal heat pumps (photovoltaics being funded under a separate £31m Major Photovoltaics Demonstration programme). The legal definition of the term microgeneration was later formalized in the 2004 Energy Act [25] and is a broader definition that includes fuel cells, biofuels, micro-CHP, wave, tide and “*other sources of energy...which would, in the opinion of the Secretary of State, cut emissions...*”. This definition has provided the flexibility to include air-source heat pumps (ASHP) in the microgeneration classification more recently.

The Clear Skies initiative was later transformed into the “Low Carbon Buildings Programme” (LCBP) that ran between 2006 and 2010 with a total funding commitment of £137 million [26]. This brought together capital grant support for photovoltaic systems into the same programme as the other microgeneration technologies. The majority of the funds went to householders and non-profit organizations providing housing (termed Registered Social Landlords or RSLs in the UK). Separate funding streams within the LCBP were initiated for medium and large-scale systems with capacities exceeding the 50 kWe/45 kWth limits imposed in the Clear Skies programme. A second phase of the LCBP extended funding to community non-domestic buildings after 2007. Of the various microgeneration technologies supported, more than 75% of the funding went to support solar thermal and PV systems and only 8.2% to support geothermal heat pumps [26].

The end of the LCBP programme (2010) coincided with a change in UK government and a pause in the funding of capital grants for householders. Development of a novel tariff-based support programme for renewable heat [27] was initiated following the Climate Change Act 2008 and the development of a national renewable energy strategy [28] that recognized increasing adoption of renewable sources of domestic heating would be an essential element of the national commitment to carbon reduction. These plans evolved into the non-domestic Renewable Heat Incentive (RHI) programme in 2011 and a domestic RHI scheme that was to start in summer 2013 [29]. Although this had been planned before the change in government, the new government continued to develop this approach but raised questions as to lack of budgetary control [30]. Consultation was extended and finalization of tariff rates delayed so that payments for domestic installations could not start until April 2014. An interim domestic capital grant (voucher) scheme was eventually introduced to boost the uptake of renewable

heating technologies in the run-up to the introduction of RHI tariff payments. This programme was the Renewable Heat Premium Payment (RHPP) programme [31] and ran in 2012–2013. This programme offered £1250 capital grants for domestic GSHP installations but with the condition that the money would be reclaimed if RHI payments were claimed later.

1.3.2. Energy Supplier Obligation Programmes

Privatization of the UK electricity industry following the Electricity Act 1989 and the gas industry following the Gas Act 1994, also saw the establishment of respective independent regulatory authorities, OFFER and OFFGAS. The legislation gave the regulators powers to set binding standards of performance on the energy suppliers. In particular, a series of Energy Efficiency Supplier Obligation Programmes (EESOP 1–3) were established that obligated the suppliers to implement measures—usually working with third-party contractors—that could be demonstrated to save energy [32] and that were assessed with respect to an annual target set by the regulator. The three EESOP schemes ran between 1994 and 2002 with the savings targets ultimately set at 4.9 TWh (electricity) and 6.1 TWh (gas) and programme costs of £55million per annum. The regulations allowed the costs to be passed on to the consumer directly—initially amounting to £1 per annum per customer. These programmes achieved their savings targets for the most part by funding retrofits of insulation in homes but also boiler replacements and (for a limited period) heavily subsidized distribution of compact florescent lamps.

After 2002 (*i.e.*, around the time of the initial growth of the GSHP industry noted earlier and concurrently with Clear Skies) the supplier obligations took the form of the Energy Efficiency Commitment programme (EEC1) [33] followed by EEC2 in the 2005–2008 periods [34]. These were significantly more ambitious programmes with target savings set at 62 TWh and 130 TWh and programme spending of £500 million and £1.2 billion respectively. These targets (following revised legislation in the Utilities Bill 2000) were set by the Secretary of State for Energy rather than the independent regulators [32]. There were three changes between the EESOP and EEC programs that are significant in this context. In the EEC there was firstly, a specific intent to address fuel poverty (Fuel poverty is defined in this context as the situation where consumers spend more than 10% of their income on energy), secondly application to domestic properties alone and, thirdly the application of microgeneration technology alongside conventional energy saving measures [32].

In the run-up to the start of the EEC1 programme, it was proposed that GSHP systems could make a contribution to reduction of fuel poverty if they could be successfully incorporated into small social housing properties. This was appealing to RSLs in that they had become under obligations to improve housing standards after the publication of new government policy in the Housing Green Paper of 2000 [35]. GSHPs were, in principle, a very effective way of reducing running costs and improving thermal comfort in properties using coal or oil. Social housing projects also offered the potential for economically scaling-up installation into projects that could be managed in conjunction with energy suppliers. This concept was taken up by a consortium led by John Parker at Earth Energy Engineering, the energy supplier Powergen (later Eon), a GSHP installer, and a UK heat pump manufacturer, Calorex [36]. The regulators were persuaded that sufficient energy and carbon savings could be achieved over the lifetime of the system and so new GSHP installations could count towards the EEC energy saving targets. The energy supplier was satisfied this could be done at an acceptable cost.

A new heat pump was developed that was optimized for smaller UK properties that needed both heating and hot water generation and could operate with radiator heat emitters and simple controls [37]. This form of GSHP system (denoted the Powergen “heatplant”) was first installed at ten new Metropolitan Housing Trust properties in Nottingham in 2001 [38,39] followed by a project in Cornwall with Penwith Housing Association (Figure 2) involving retrofit to fourteen small properties [40]. The system was deployed at other social housing projects (mostly retrofit to off-gas-grid properties) during the EEC1 programme [41] and in growing numbers during EEC2. We describe the technical development of the heat pump later in the paper.

Figure 2. (a) Drilling operations at a social housing project in 2002 [40]; (b) an example of a “heatplant” installation in a small house retrofit project [36].



(a)



(b)

The Supplier Obligations took the form of a programme known as the Carbon Emissions Reduction Target (CERT) in the period 2008–2012 [42]. In this programme the effectiveness of the measures implemented by the supply companies was assessed against a lifetime carbon emission reduction rather than an energy reduction target. The Department of Energy and Climate Change set this target at a total of 293 million tonnes of CO₂. The programme expenditure amounted to approximately £1.2 billion per annum and this corresponded to approximately £51 per annum added to consumer bills [32]. In this programme, minimum levels of performance were imposed for certain measures (e.g., 68% for insulation) but not minimum levels of support for GSHP or other microgeneration technology installation. However, as measures in the CERT programme were assessed in terms of

carbon emission savings, there was additional motivation to implement GSHP retrofits where the original form of heating had been electric resistance, or even coal fired heating.

The most recent form of the UK supplier obligation policy (2012–2017) has been the Energy Company Obligation (ECO) programme [43] that had an initial budget of £1.3 bn. The budget was split between three sub-programmes. These were: the Affordable Warmth Obligation (targeted at households at risk of fuel poverty); the Carbon Saving Obligation (targeted at insulation of “hard-to-treat” houses), and; the Carbon Saving Communities Obligation (targeted at specific economically deprived areas). The ECO programme has differed from the CERT programme in having a distinct emphasis on insulation measures. The “innovation” measure that encouraged a modest level of GSHP uptake in the CERT scheme was removed. The programme budget and scope was changed in 2014 and we comment on this further in the final discussion section of this paper.

1.3.3. Support Programme Outcomes

Some measure of the significance of these support programmes can be made by comparing the total GSHP installations reported by the industry noted above, with the numbers of installations supported by grants that have been disclosed. We suggested earlier that the 2000–2005 period was significant in terms of the establishment of the UK GSHP installation industry as installations grew from 40 at the start of this period to approximately 500 by 2005. This period corresponds largely to the implementation of the Clear Skies programme in the UK. In 2005 it was reported that 500 GSHP installations had received grants under this programme [44]. Although the EEC1 supplier obligation programme was in effect in this period, it provided support for only 40 installations [33]. The LCBP that followed on from the Clear Skies initiative, and ran until 2010, supported the installation of 1573 GSHPs. These were nearly all domestic systems with 843 grants given to individual households and the remainder of the GSHP systems being delivered via grants to RSLs and other non-profit organizations [26].

Although the portion of the Clear Skies funding that was directed into GSHP installations was relatively small, an important aim of the programme was dissemination of information about microgeneration technologies to householders and other stakeholders—lack of information being a recognized barrier to uptake of renewable technologies and energy efficiency measures [45,46]. We suggest that this was particularly important in view of the fact that this was the UK’s first comprehensive consumer focused renewable energy support programme. Although some microgeneration technologies in the programme, such as solar thermal, had some record of success in earlier decades and something of a public profile, very little information relating to geothermal heat pump technology had been made available to the public in the UK. We suggest there was some benefit, in terms of promotion of information, from GSHP technology being presented alongside other renewable technologies as part of a broad programme of microgeneration deployment.

A criticism of the first phase of the LCBP programme, based on responses to questionnaires completed by individual householders, has been that a significant number of grant recipients would have purchased a system even if they had not received a grant [26]. It is not clear to what extent this was true of GSHP installations as compared to the other technologies in the programme (80% of the funding went to solar thermal and PV installations). This may reflect two other factors: firstly, that the

grants provided a mean of only 10.6% of the GSHP installation cost; secondly, the demographic data showed that most of the householder grants went to owners of relatively large properties (4 bedrooms or more) and so these respondents may have had good access to other funds.

The administrators of the LCBP programme have acknowledged this criticism [26] but suggest that the programme had broader value in developing a quality assurance framework (the MCS discussed below) that was important to establishing good market conditions and incubating the industry. The same criticism was not made of the second phase of the LCBP that had provided grants to non-profit community organizations. This funding differed in that the grants were larger (a mean of 46.6% of the total cost) and for systems with higher capacity (a mean of 40.3 kW per scheme). We suggest that having a national programme like Clear Skies and LCBP that offered some assurance of quality and independent consumer advice also played an important role in encouraging new SMEs into the GSHP installation industry at what was an embryonic stage in its development.

The three supplier obligation schemes that have run through the period of interest (EEC1, EEC2 and CERT) have seen only a small proportion of programme funds spent on GSHP installations. However, as these schemes have grown to become substantial streams of funds, the number of domestic GSHP systems that have been funded has amounted to a significant proportion of the total installed in the UK. The EEC1 scheme was established when interest in GSHP was embryonic and saw only 40 GSHP systems installed before the advent of EEC2 [33]. The EEC2 programme ran concurrently with much of the LCBP and funded the installation of 1500 GSHP systems [34]. The most substantial supplier obligation scheme, CERT, provided funding for 4497 installations between 2008 and early 2011 [42].

The supplier obligation programmes did not have the same public information dissemination and independent advice brief as Clear Skies and LCBP. However, their impact on the development of the GSHP installation industry is probably greater in view of the overall number of systems they funded and the fact that the level of support was greater. Many of the projects funded consisted of groups of properties—both new and retrofit—and this allowed some economies of scale to be gained. For example, as the mobilization costs associated with drilling operations are substantial, it is more efficient to drill at groups of properties than at individual houses in different locations. This was to the benefit of the SMEs entering the industry (including drilling contractors) and to clients in reducing costs. There is evidence that in social housing projects funded by these programmes, there have been fuel poverty benefits for tenants as a result of the GSHP installations, particularly where the heating fuel was previously oil or coal, or the heating system was electric resistance heating—addressing fuel poverty has been one of the aims of the supplier obligation programmes.

Taken together, the Clear Skies, LCBP and RHPP programmes provided grants for 4022 installations. The supplier obligation schemes provided funding for a total of 6037 installations. The annual installation data is shown over the 2000–2013 period in Figure 3 and highlights the significance of the number of systems supported by both types of programme in relation to the total number of systems installed. Altogether, the support programmes have funded 10,059 installations representing 57% of the total installations reported [13,47]. Prior to 2006 a high proportion of the installations have been supported by the Clear Skies programme. These data show 2006–2009 was a period of rapid expansion of the industry during which the number of installations supported by private funding has also grown significantly. In the 2009–2012 period much of the growth appears to have come from the

CERT programme. In the April 2012 to December 2013 period, the growth is almost entirely attributable to the RHPP programme.

Figure 3. Growth of ground-source heat pump (GSHP) installations in the UK part funded by public capital grant programmes (Clear Skies and “Low Carbon Buildings Programme” (LCBP)), energy supplier obligation schemes (EEC1, EEC2, CERT) and, the most recent Renewable Heat Premium Payment (RHPP) grant programme. Data for total installations is a combination of data reported by WREC [1], BSRIA [48] and EurObserv’ER [13]. Installations funded without grant support are categorized as “other funding” in this figure.

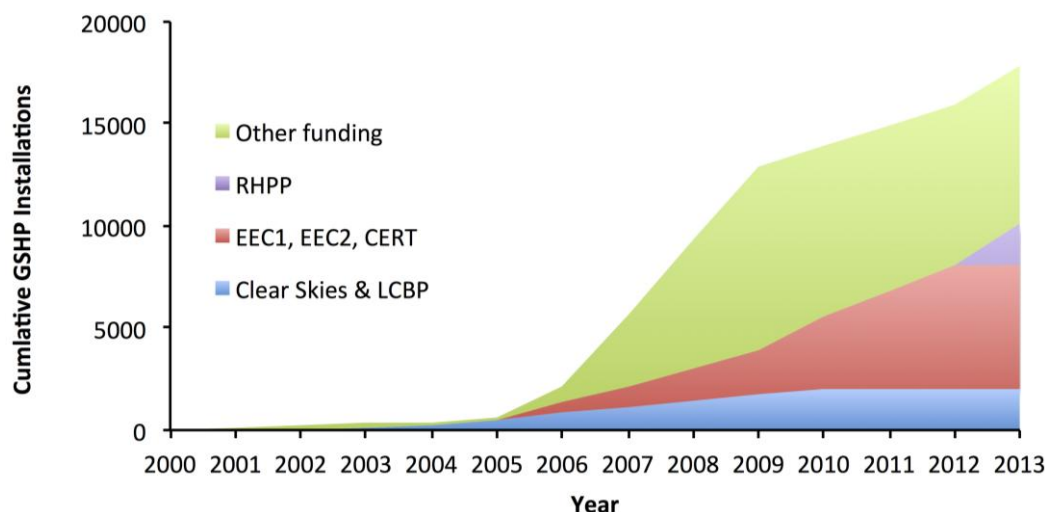

1.4. Other Supporting Measures

The importance of accessible consumer information, development of standards and skills to the acceptability and uptake of domestic renewable energy technologies and development of installation industries has been widely acknowledged [44,45]. National support programmes such as Clear Skies and the LCBP have played an important role in the dissemination of information (e.g., case studies [49]) together with related quasi-governmental organizations (e.g., the Energy Saving Trust, EST) in the provision of consumer advice. Although the UK GSHP installation industry broadly acknowledged the need for coordination with regard to promotion, research, publication, training and standards there was no obvious professional or trade body in existence with which it could align (the Heat Pump Association and the British Drilling Association probably are the most closely related).

Progress towards an industry body was made by the formation of the “Ground Source Heat Pump Club” in 2004. This organization was hosted by the National Energy Foundation (NEF)—a non-profit entity that had a record of promotion and support for energy efficiency and renewable technology industries. This club later became a more formally organized trade body in the form of the Ground Source Heat Pump Association and has become independent of NEF [50]. The body has been able to make representation to government departments on behalf of the industry with some success [51] and has taken something of a lead in developing industry standards and training.

Where there is rapid development by entry of new installers into a market for a relatively novel form of renewable technology, there must be some risk of adverse consequences to the health of that market if system design, products and installations fall short of good practice. Development of the

Clear Skies programme (2002) was accompanied by governmental recognition of the value of both product labeling and installer quality assurance measures as part of the development of a national microgeneration support programme (product labeling for boilers and certification of installers was already well established). To this end, the programme initiated a requirement for grants only to be made for installations completed by registered installers and for registered products. This aspect of the programme later became the Microgeneration Certification Scheme (MCS) [52] which formalized the requirements for installer registration and started to introduce new installation standards for each of the technologies supported. An installer standard for domestic GSHP systems was first introduced in 2008 and has been developed significantly in light of the monitoring and performance evaluation programmes discussed below. There is evidence that development of the standard for heat pumps has had an important role to play in seeing that the lessons learned from the field trials are translated into practice—as we discuss later.

The technical complexities of GSHP systems are reflected in the blend of skills and knowledge required for implementation and consequently reflected in the training needs of the installation industry. At the professional level, some geological, geotechnical and HVAC engineering competence is required. At technician level, skills that are normally divided between drilling, heating systems and refrigeration competences need to be brought together. The dominance of fossil fueled hydronic heating in the UK has meant that heat pumps have never featured in heating technician training and only appeared in refrigeration and air conditioning training programmes. The need for appropriate training programmes that give some assurance of quality implementation and, at the same time, ensure the supply of suitably trained personnel is not a constraint on growth was recognized in the articles of the EU RES directive. The directive required all member states to have training programmes for renewable technologies like GSHP in place by 2012. Progress towards this end has been slow in most Member States.

Some effort has been made in the EU to develop coordinated heat pump technician training in the form of the EU-HPCERT programme [53]. The GEOTRAINET project has sought to develop training materials and programme frameworks for drilling experts and building design professionals. These programmes are yet to be implemented in a nationally coordinated manner in any EU Member States. In the UK progress is being made on the part of the drilling industry [54] and the GSHPA is leading efforts to engage the qualification accrediting and awarding bodies that have oversight of technician training and qualifications [55]. Although many colleges have taken initiatives to include renewable heating technologies in technician training there is still not an obvious place for this to fit with recognized qualifications. The primary mechanism for assuring personnel are competent remains the MCS scheme. This does not require particular levels of recognized qualification and allows more than one route to registration. Assurance mostly comes from a need for contractors to be audited [56]. Training in the requirements of the MCS installation standards is currently provided by third-party training bodies and heat pump manufacturers. The need for a nationally recognized system of training and qualifications that is integrated with existing accredited courses remains.

2. System Performance Evaluation

2.1. Performance Metrics and Benchmarks

Whether one wants to compare theoretical and actual thermodynamic performance, energy efficiency, running costs or carbon emissions, some form of metric that is a ratio of useful heat output to electrical energy input is required. The thermodynamic metric Coefficient of Performance (COP) is useful to define rates of heat transfer in relation to power at a particular steady-state operating condition. This is useful in the context of product specification (catalogue data), labeling and standards (e.g., EN 14511-2 [57]) to enable heat pump devices to be compared at the design stage and with reference to the theoretical Carnot efficiency. However, if one is concerned with realistic operating conditions, then an integrated measure (*i.e.*, based on energy rather than power ratios) that recognizes the heat pump device as part of a larger heat delivery system is required. Such metrics are commonly termed Seasonal Performance Factor (SPF). Their definition is highly significant if one wants to address the question of what forms of heating system should be supported as part of a national carbon emission reduction strategy, expected running costs and what constitutes the renewable energy output of heat pump systems.

Precise definition of SPF that is applicable to a range of system configurations is not easy to establish. The EU standard EN15316-4-2 [58] defines SPF as “*the ratio of the total annual energy delivered to the distribution subsystem for space heating and/or domestic hot water to the total annual input of driving energy ... plus the total annual input of auxiliary energy.*” Gleeson and Lowe, in an analysis of available data and metrics [59], identified thirteen different variations in the definition of SPF in several heat pump trials so that it appears the definition in EN15316-4-2 is not sufficiently precise. The complications arise as different numbers of circulation pumps, buffer/storage tanks, and supplementary electric resistance heater can be found in practical heat pump systems—many of which provide both space heating and domestic hot water. This complicates comparisons between different field trials and between different heating technologies significantly. It furthermore complicates what are the most appropriate monitoring arrangements and what can be deduced from the results [60].

This issue has received attention during the period we have reviewed (e.g., [61]) such that there has been some movement towards a consensus following the SEPEMO-Build project which sought to derive well defined forms of SPF metric that could be practically measured and form a useful basis of performance comparison [62]. This methodology defines four metrics— SPF_{H1} , SPF_{H2} , SPF_{H3} and SPF_{H4} —that have an increasing number of electrical energy inputs included respectively. SPF_{H1} includes only the heat pump compressor and auxiliary energy (controls *etc.*) and will have the highest value of these metrics (closest to the steady-state COP). SPF_{H2} also includes the ground loop circulation pump electrical energy. SPF_{H3} includes any electrical energy associated with a boost resistance heater in the heat pump package. SPF_{H4} further includes the electrical energy associated with the heating or hot water distribution system. The EU has accepted these definitions for defining the renewable energy delivered by heat pump systems [63] and are discussed in detail in UK field trial documentation [64]. The system boundaries are indicated in Figure 4.

Figure 4. System boundaries and their relation to Seasonal Performance Factor (SPF) metrics 1–4. The system efficiency recorded in the first phase of the UK national field trials (SEFF) can be considered SPF_{H5} and includes the output of the hot water system.

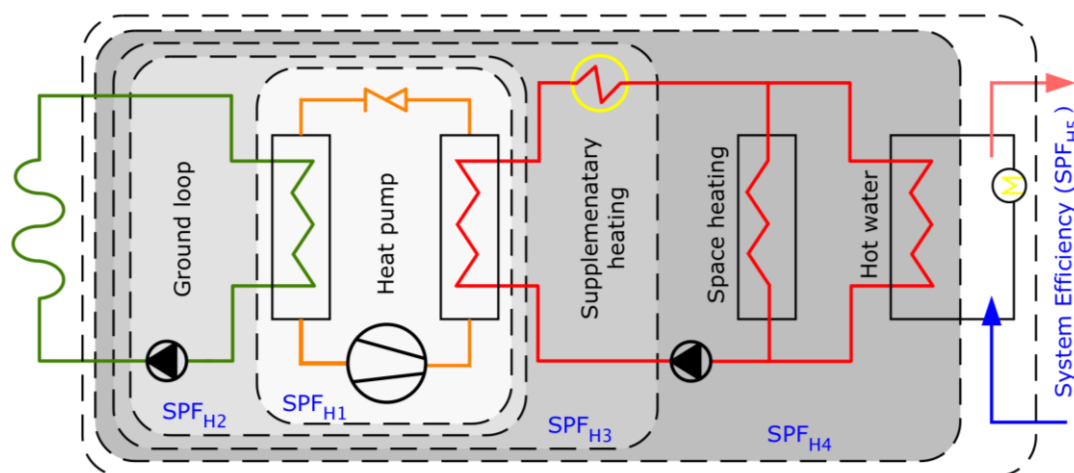

If the aim is to compare the seasonal performance of heat pump systems with other forms of heating and hot water production (gas fired boilers being the most relevant alternative in the UK) then either SPF_{H2} or SPF_{H4} could be appropriate metrics. SPF_{H2} is often easier to measure as it only includes the main equipment in the heat pump cabinet (excluding any built-in boost electric element) and the ground-loop circulating pump. The equipment included (and monitoring points required) to measure SPF_{H4} varies considerably according to the configuration of equipment outside the heat pump cabinet—principally whether buffer and/or hot water tanks are separate components or are not required and the number of circulation pumps. The metric SPF_{H4} is arguably the most appropriate if one is to consider likely energy costs. In the recent UK evaluations of heat pump performance [64,65] SPF_{H4} has been adopted for most comparisons. In evaluating both the minimum performance standard and the renewable energy contribution made by heat pumps SPF_{H2} has been adopted within the EU [63].

What, then, might be regarded as a minimum level of performance that should be expected? The question has been asked for a number of reasons—both with a view to householder expectations and broader performance of the housing stock with GSHP—and might be answered from an energy, carbon emissions or cost perspective. Broader assessments such as Life Cycle Analysis [66] and Carbon Footprinting [67] have been put forward in academic studies. In both these broader forms of assessment operating efficiency (*i.e.*, SPF) is also the most significant parameter [67].

The approach taken in the EU (with respect to the Renewable Energy Sources (RES) directive [68]) is based on consideration of primary energy *i.e.*, input at the power station. This is reasonable if one seeks to make a simplified comparison with systems that rely on local combustion of fuel such as gas, oil or biomass boilers in terms of overall energy efficiency. The minimum performance in order for a system to be counted as a renewable energy source is defined by an SPF_{H2} value greater than $1.15/\eta$, where η is the ratio of (at national grid level) electrical energy delivery to primary energy input and 15% distribution losses are assumed. The value of η varies from country to country and over time (gradually increasing) but for the sake of uniformity and application over the 2010–2020 timeframe, a conservative value of 0.455 has been agreed [63]. The means, after rounding, a minimum SPF_{H2} value of 2.5 is required.

With respect to seasonal efficiency levels in the UK, and comparison with other forms of heating in the context of a national carbon emissions reduction strategy, the metric SPF_{H4} can be used to define benchmark efficiencies along with fuel carbon factors and the efficiency of the alternative system. This form of analysis helps answer the question as to what level of performance is required for a GSHP to have an advantage over other forms of heating in terms of carbon emissions rates. This is a simple calculation and such results have recently been reported [47]. If the comparison is made between a natural gas fired systems (carbon factor 0.185 kgCO₂/kWh) and a heat pump using grid electricity (carbon factor 0.480 kgCO₂/kWh), the minimum SPF_{H4} in order to show lower emissions is 2.21. This assumes the seasonal efficiency of modern gas boilers is 85%—a value reported in recent boiler national trials using similar methodology to the heat pump field trials [69]—and that room conditions are comparable. When compared to other fuels the minimum value is lower: compared with oil the minimum would be 1.65; compared to Liquefied Petroleum Gas (LPG) the value would be 1.9.

Similar calculations can be made to find the minimum SPF required for the GSHP system to have lower running costs than other forms of heating. Using nationally reported unit fuel costs (2013 values) the minimum SPF_{H4} required when compared with the annual energy cost of a natural gas fueled system would be 2.49 according to the Department of Energy and Climate Change (DECC) [47]. Compared to an oil fired system this value would be 1.82 and compared to a low-tariff electric night-storage resistance heating system, the value would be 1.5 [47].

Given the benchmark minimum SPF_{H4} values noted above, and that the differential between SPF_{H4} and SPF_{H2} is fractional [47] (in the approximate range 0.1–0.3), the EU benchmark of 2.5 for SPF_{H2} seems quite appropriate for the UK at present.

2.2. National Field Trials and Monitoring Programmes

The Energy Saving Trust (EST) has been responsible for coordinating national-scale field trials of a number of microgeneration technologies during the Clear Skies and Low Carbon Buildings Programmes. In 2008 a new trial was organized to evaluate the “real world” performance of domestic heat pump systems—both air and ground source [70]. This field trial was funded by a number of energy suppliers (who had already installed a significant number of systems by 2008) and several heat pump manufacturers and installers. The broad aim was to evaluate the differences between stated (lab-based) performance and the seasonal performance when installed and operated in typical households—in a similar manner to earlier national trials of solar thermal and photovoltaic (PV) domestic systems. The methodology included technical monitoring but also analysis of user surveys. This was the first large-scale trial of domestic GSHP systems in the UK. The results of this trial and the follow-on monitoring programmes, have received a good deal of scrutiny and proved a useful source of evidence to those interested in grant support policy, national carbon reduction strategies, product development, installation standards and the broader debate as to the future role of GSHPs in the UK.

The trial sought to collect evidence from a broad sample of systems that had already been installed. The systems included in the trial were accordingly widely distributed around the UK. The population of 83 sites (54 GSHP, 29 ASHP) included a range of: building forms, type of heat emitter, new and retrofit installations, tenant and owner-occupied properties and hot water provision. A few systems were integrated with solar thermal systems. In addition to the system electrical demands and heat

outputs, other data collected included ground loop temperatures, internal and external air temperatures, energy costs, installation configuration and sizing data. A total of 14 different heat pump manufacturers' equipment were included in the sample. This 'phase 1' trial data was collected between Spring 2009 to Spring 2010.

2.2.1. National Field Trial Results (Phase 1)

The practicalities of instrumenting a wide variety of different heat pump products and system configurations seem to have proved more complex than expected so that energy flows could not be resolved to the system boundaries defined as SPF_{H2} or SPF_{H4} for the first phase data. The efficiency metric reported was denoted "system efficiency" and is essentially expanded from the SPF_{H4} boundary so that domestic hot water energy was measured at the outlet of the storage cylinder rather than the inlet (see Figure 4). Values can, accordingly, be expected to be lower than SPF_{H4} values. The difficulty with this definition is that, particularly in systems with separate storage cylinders, the measured hot water energy is sensitive to tank losses; cold water feed temperatures and usage pattern [60]. (It should also be said that at the time of the first phase of the field trials there was no consensus as to monitoring standards and the work emerging from the SEPEMO project was yet to be published). In DECC's first RHPP data analysis [47] the system efficiency data from the first phase EST trial was redefined as SPF_{H5} (see Figure 4).

The system efficiency data derived from the phase 1 measurements from GSHP installations is summarized in Figure 5 in the form of a histogram. The sample size finally reported was reduced to 49 GSHP and 22 ASHP after some data was rejected for quality control reasons. The mean GSHP system efficiency was reported as 2.39 and the range as 1.55–3.47. The corresponding results for ASHP were a mean of 1.83 and range of 1.2–2.2.

Of the ten key findings stated in the final report of this first UK national field trial [70] those that received the most attention were "*The system efficiency figures for the sample of ground source heat pumps were lower than those monitored in similar European field trials*" and "*Heat pump performance is sensitive to installation and commissioning practices.*" [70]. The first of these findings is evident from comparisons with trials in Germany, Switzerland and Denmark [59]. The second finding is also clear if one considers the differences between the equipment rated COP values stated by manufacturers and the measured efficiencies. Installed seasonal efficiencies were expected to be lower but not by so much or with such a large range. Although the performance of some systems was good, and comparable with other European reports, a mean value of 2.31 is low in relation to the EU benchmark for renewable systems of 2.5. An independent study [60] that collected data in the following year reported similarly disappointing system efficiencies (along with slightly higher SPF_{H4} values) from a sample of 10 small RSL properties in Harrogate that used the same heat pump: mean 2.21; range 2.12–2.33.

Figure 5. GSHP system efficiency (SPF_{H5}) data reported from Phase 1 of the national heat pump field trials. Data from [70].

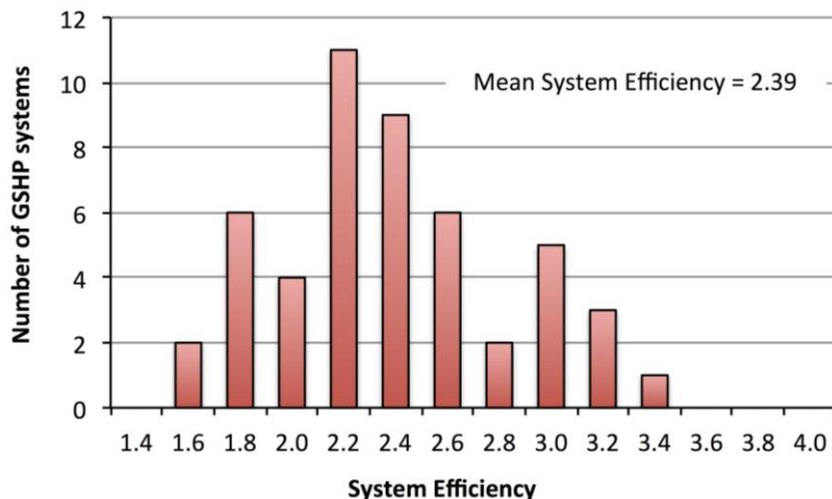

2.2.2. National Field Trial Results (Phase 2)

Some of the systems in the phase one trial could arguably be regarded as faulty or even failures and unduly skewing the results and so should have been excluded from the final results presented. The counter-argument is that the sample represented industry practice and what users were experiencing. In any case, the large range of system efficiencies indicated poor design and installation practice in all but the upper quartile of installations. The Department of Energy and Climate Change (DECC) initiated a programme of detailed data analysis in cooperation with the EST and heat pump installers in 2010 to identify likely technical factors in the poor performing systems [71]. The main consequences of this were further development of the Microgeneration Installation Standards [72] that we discuss later in this paper and, concurrently, initiation of a second national field trial.

The second phase of the national field trials sought to take advantage of what had been learnt from the detailed technical analysis [71] and saw implementation of a set of intervention measures at 32 of the original sites identified as poorly performing. Some well-performing sites from phase 1 were also included in the sample. The sample comprised 21 GSHP installations and 15 ASHP. The level of instrumentation was increased so that it was possible to separate out SPF_{H2} , SPF_{H4} and system efficiency (SPF_{H5}) values for nearly all the systems. The intervention measures were classified as major (12 sites), medium (9 sites) or minor (11 sites). Major interventions included replacement of a heat pump and repairs to a ground loop. Medium interventions included installation of a new hot water tank, new radiators and circulating pumps. Minor interventions included additional insulation and modified control settings [65].

Results from a further year of monitoring were presented in the form of SPF_{H2} and SPF_{H4} (DECC having adopted the latter metric for comparisons with other heating systems) and these are summarized for the GSHP systems in Figure 6 [64]. The mean SPF_{H2} value for the GSHP sites was 3.1 and the mean SPF_{H4} value (20 of 21 sites) was 2.82. When monitored SPF_{H2} values were compared with the EU benchmark (2.5) 20 of the 21 GSHP sites was found to exceed this. Of the sites that had either major or medium interventions made, 17 of the 20 showed noticeable improvements in system

efficiency. Three showed small deterioration in system efficiency (the results are not broken down into GSHP or ASHP and so it is difficult to comment further). Of the sites where minor or no interventions were made there were small changes in system efficiency but a similar number showed improvement as showed deterioration [65]. The range of results remained significant and suggests that installation and design practice remained variable. User behavior was found to be significant in some cases (related to hot water usage). Although it was only possible to upgrade a relatively small number of the monitored systems to the new requirements, the measures addressed in the revised installer standards were judged to be validated by the improved results [64].

Figure 6. Seasonal Performance Factor data (SPF_{H2} and SPF_{H4}) reported from Phase 2 of the national field trial (after implementation of improvement measures). Data from [64].

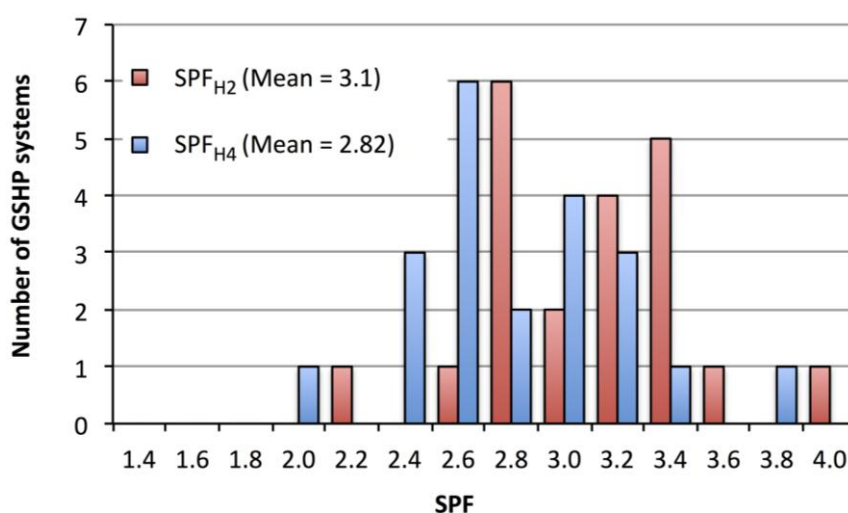

2.2.3. Initial RHPP Performance Data

The RHPP programme was a means of providing capital grants to householders and RSLs for renewable heating equipment in anticipation of the RHI tariff scheme. Monitoring of heat pump installations was incorporated into the programme and built on the methodology developed in the earlier national field trials. Householders were incentivized to participate in the monitoring exercise by modest additional grant payments. The result has been that a significantly larger sample has been included in the monitoring exercise (124 GSHP in the sample after data quality control). Performance data from December (Testing showed December was reasonably representative of heating season behavior without temperature correction [47]) of the first phase of the programme (August 2011–March 2012) was presented later in 2013 [47]. System efficiencies (*i.e.*, SPF_{H5} , calculated with some assumptions about hot water losses) from this report are shown along with the EST trial phase 1 data in Figure 7. The SPF_{H4} data is shown in histogram form in Figure 8 along with data from the national field trial phase 2.

There are some differences in the approach taken to monitoring and data analysis in the RHPP data compared to the earlier monitoring programmes besides the fact that the sample size is larger. Detailed diagnoses of poorly performing systems were not attempted in the same way as Phase 2 of the field trials. Hence, although installers were active in correcting faults, these were not prompted by interventions recommended following analysis of monitoring data. The seasonal performance data

such as that presented in Figures 7 and 8 is consequently representative of industry design and installation practice in 2012–2013.

Figure 7. Seasonal Performance Factor data (SPF_{H5}) reported from December 2013 RHPP programme data [47] and compared with the Energy Saving Trust (EST) national field trial Phase 1 data [71]. Data from [47,71].

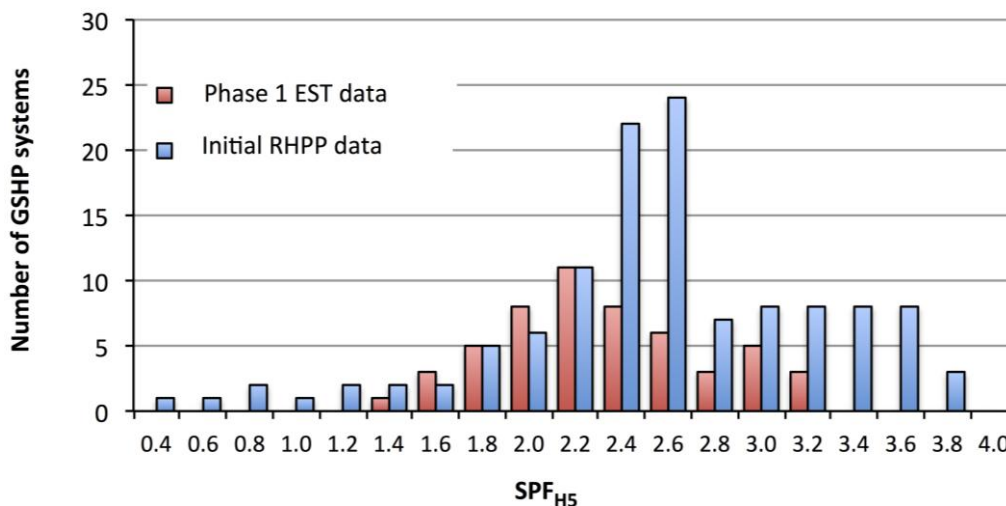
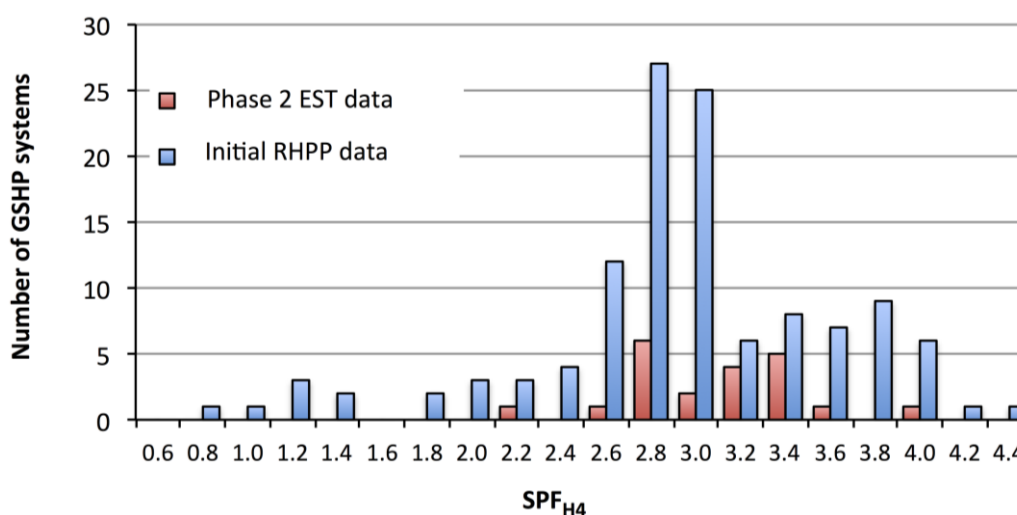

Figure 8. Seasonal Performance Factor data (SPF_{H4}) reported from December 2013 RHPP programme data [47] and compared with the EST national field trial Phase 2 data [64]. Data from [47,64].



The December 2013 RHPP data [47] is indicative of some improvement in seasonal performance in that both the mean SPF_{H4} and SPF_{H5} efficiencies are increased relative to those found in both phases of the earlier EST national field trials. The mean SPF_{H4} was found to be 2.92 (2.82 in phase 2) and the mean SPF_{H5} to be 2.74 (2.39 in phase 1). However, the ranges of the efficiencies continue to be significant—a long tail with relatively few values being evident at the lower end of the range—although this may reduce when a whole season of data is included in the analysis and further quality checks are made. Comparisons with the EU renewable energy benchmark ($SPF_{H2} > 2.5$) and estimates of carbon emissions and energy cost reduction relative to other heating systems were also

presented. Of the GSHP installations, 84% were shown to be above the EU threshold. Using analysis similar to that noted in Section 2.1, 64% of the GSHP systems would have shown reduced fuel costs relative to natural gas heating systems. The percentage of systems resulting in cost reductions was increased for other fossil fuels. The percentage of systems showing reduced carbon emissions relative to natural gas heating was 88%—and higher when compared to other fossil fuels [47].

2.3. Grant Recipient Characteristics, Experiences and Behavior

All the support programmes providing grants to individual householders (Clear Skies, LCBP and RHPP) have collected user data from grant recipients. These data have included feedback about the operation of the programme and satisfaction with the system along with information that characterizes the property, type of system and location [26]. In the first national field trials the EST and Open University researchers (Caird *et al.* [73,74]) sought to investigate the relationships between operating efficiency and the behavior and characteristics of the users by employing questionnaires and carrying out in-depth interviews with householders. The population consisted of 78 users of which 48 were private households and 30 were social housing tenants. Fifty of the properties had GSHP systems and the remainder used ASHPs. The study of ten social housing installations in the later Harrogate study [75] included user surveys using a similar questionnaire and interview approach.

Overall levels of satisfaction with the heat pump systems in the EST field trial (phase 1) were good: 83% of users agreed or strongly agreed that the system made their home warm and comfortable; 86% of users said the system met their domestic hot water requirements [73]. Although these levels of overall satisfaction were high, responses to detailed questions showed only 63% of users were satisfied with the level of support they received from the suppliers of the system and only 62% were satisfied with the running cost savings. This dissatisfaction is to some degree a reflection of the technical problems and poor efficiencies measured during the first phase of the trial [70].

There were several questions in the survey used by Caird *et al.* [cite references] where responses noticeably differed according to whether the users were social housing tenants or private householders. Ownership status, in itself, was not necessarily an indicator of cause as ownership also correlated with property and system characteristics—Social housing properties were smaller, had a higher proportion of radiators and lower building fabric standards. A greater number of social housing properties were retrofit with heat pumps rather than being new properties. Private houses tended to be newer, better insulated and a higher proportion had under-floor heating. Private householders also interacted with the purchasing, installation and commissioning processes in a different manner to social housing tenants. Private householders tended to be involved with information collection and decision-making earlier in the process whereas, in the case of social housing installations, the landlord procured the system.

One aim of Caird *et al.* [73] was to try and establish any correlations between user characteristics, behavior and system performance. To this end, they categorized installations according to whether their system efficiency fell below 2, in the interval 2–2.5, or above 2.5 and examined the correlation with type of heat pump and ownership status. Their most significant finding was that 95% of the best performing systems were in private households. This was partly a reflection the characteristics of the systems in that a higher proportion of private households had GSHP and under-floor heating. However,

Caird *et al.* [73] also point out that there was a higher level of knowledge and understanding of the systems among private households: 82% of users of the higher performing systems stated they had either “a fair amount” or “a lot” of knowledge and understanding of the heat pump system and only 4% of social housing tenants stated they had a “lot” of knowledge [73].

A significant cause of dissatisfaction amongst users in the EST field trial was the difficulties in understanding the system operating instructions and uncertainty in how best to operate the controls [73]. Forty four percent of all heat pump users said they were uncertain how best to operate the controls and this was expressed almost as equally by private householders (17 of 32) as social housing tenants (15 of 32). Responses to these questions where one element of the survey that differentiated GSHP negatively was in that 22 of those dissatisfied were users of GSHP systems and 10 were users of ASHP.

Other behavioral factors that were investigated included user choices about operating temperatures, window opening and system time control. Users were typically advised to leave the system on (enabled) at all times. This is firstly reflected in the fact that 76% of all users left the system on all day and night. This proportion was higher among private householders (85%) and GSHP users (85%). This practice is reflected in the operation of the systems with efficiency greater than 2.5 in that all of these systems were operated (enabled) continuously. Practice was more varied amongst social housing tenants and ASHP users. Although 71% of social housing tenants said they left the heating on for long periods of the day only 55% left it on all night and 59% when out of the house compared to 82% and 87% of private householders respectively. Open user responses noted by Caird *et al.* [73] suggest housing managers sought to advise tenants to leave the system on but this operating pattern was not universally accepted—most likely as it was contrary to experience with previous heating systems. This issue seems conflated with the reportedly poor written instructions that users received. As a consequence of the survey responses the EST field trial report concluded that user behavior did have an impact of performance levels and that there was a need for clearer and simpler user advice [70]. Similar dissatisfaction with operating instructions and variability in operating behavior and window operation were observed in the Harrogate study [76].

The RHPP programme collected feedback from participants through online questionnaires [77]. The body of user data was substantial as a consequence of the fact that all recipients had to complete the questionnaire online in order to claim the grant payment. This resulted in 804 sets of GSHP user data collected soon after installation of the system (phase 1 of the RHPP program) and placed some emphasis on the motivation for the purchase, experience of installation, technical support and operating instructions. A follow-up online questionnaire was completed by 544 GSHP users after the completion of the first heating season with an alternative set of questions more concerned with operating experience and behavior [77].

The levels of overall satisfaction with renewable heating systems in the programme (GSHP, ASHP and biomass boilers) were high. User satisfaction with GSHP systems was 90% in the follow-up responses. This indicates some improvement over the user experiences in the first EST field trial. However, the responses to questions about initial faults and failures and difficulties in understanding how to get the best from the systems indicated there was further room for improvement on the part of installers and manufacturers. Of the grant recipients with GSHP systems, 61% reported that they needed additional advice after installation. Twenty-two percent of GSHP system users reported

manufacturing or installation faults [77] (levels very similar to those with ASHP or biomass boiler installations). Although user satisfaction overall was high and no similar data for more conventional heating systems is available, these levels of difficulty of operation and initial faults seem high.

Although overall satisfaction with the temperatures achieved was high (95% with GSHP systems) there are some interesting trends in reported uncomfortably cold or hot periods. Air-source heat pump users reported slightly more hours being too cold at night: 13% compared to 9% for GSHP users. This may reflect some drop-off in ASHP heating capacity in the particularly cold 2013 winter [77]. Only 1% of ASHP or biomass boiler users reported being hot. Of GSHP users, 3% reported being too hot on the coldest nights. Some responses indicated GSHP users behaved differently to users of other systems. Users were asked to indicate up to three types of action they took when they felt too hot. These responses are shown in Figure 9. When comparing behavior between users of different heating system types, relatively few GSHP users changed the timing of system operation or turned the system off (15% and 9% respectively). Users of biomass boilers changed timing and system-off periods more noticeably (44% and 40% respectively). More GSHP users respond by opening windows and doors during periods when they are too hot (30% and 15%) than users of biomass boilers (11% and 7% respectively). Although the number of users in the sample affected is small, overheating suggests energy demand could be further reduced by better space temperature control.

Figure 9. User responses to overheating reported from online follow-up questionnaires in the first phase of the RHPP programme [77]. Adapted from [77].

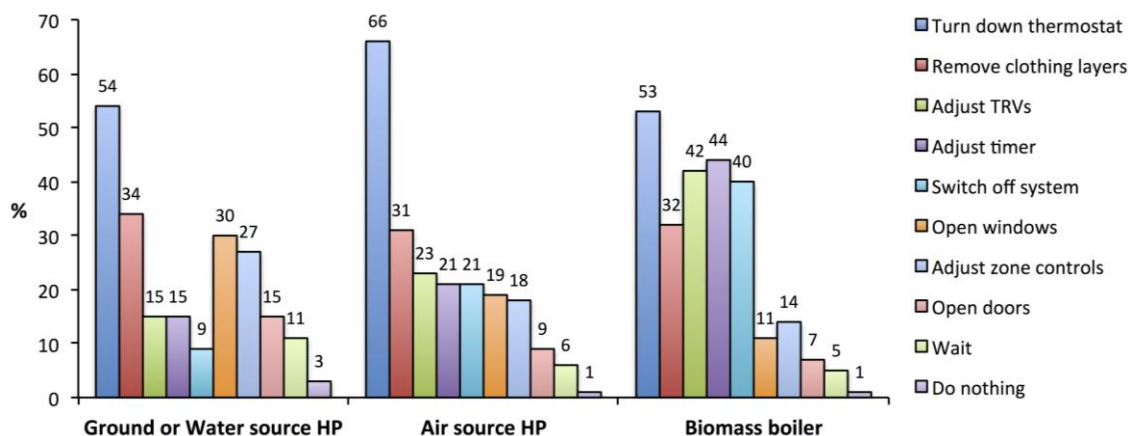

Other user data collected in the first phase of the RHPP programme [77] included information about the type of property, user income level and regional location. These data give some indication of the nature of the GSHP market at that time. The RHPP programme was conceived as a precursor to the RHI tariff programme and so RHPP user data is probably representative of initial RHI programme participants. Although some of the programme funds were ring-fenced for RSLs (who showed some preference for ASHP rather than GSHP systems [78]) the number of systems in private ownership was very much higher in the RHPP programme than previous programmes such as LCBP [26]. This is reflected in the property size and income level data: both being higher than reported in the LCBP. Regression analysis showed that both property size and income levels were furthermore higher amongst GSHP users than either ASHP or biomass users [77]. The average number of rooms in houses with GSHP systems was 4.1 and the average household income was £61,500 (UK median number of

bedrooms was 3 [79] and average earnings in this period were £27,000 [80]). The average household income of ASHP users in the programme was £10,000 lower. Compared to the other renewable heating technologies it was found significant that more GSHP installations were in new properties built for older householders planning to stay in the property for many years [77]. The characteristics of such users and their properties is in contrast to those of the many social housing properties and users that received GSHPs in larger numbers in earlier programmes and in the streams of funding within the RHPP available to RSLs. This suggests something of a bi-polar nature to the market at present with relatively few systems being taken up by middle-income homeowners in average size properties.

The RHPP user data shows some regional variation in the uptake of the renewable heating technologies supported by the programme. To be eligible to receive a grant, users had to be off the gas grid. This firstly means that most installations are further from the central axis of England, further from the central urban belt in Scotland and more frequently occur in the southwest and eastern England, Wales and the border and highland regions of Scotland. Air-source heat pumps installations have been geographically widely dispersed. However, the mapping data [77] shows something of an inverse relationship between biomass boiler and GSHP adoption. For example, in parts of Scotland there is good availability of biomass fuel and GSHP installations are much less common than biomass boilers. Conversely, in the east of England there is very little forestry and so a higher density of GSHP installations and many fewer biomass boiler installations were reported.

3. Technology Adaptations and Development

One of the key findings of the first phase EST national field trial was that “the system efficiency figures of the sample of ground source heat pumps were lower than those monitored in similar European field trials” [70]. This finding led to questions as to whether this was related to poor design and installation practice, or whether there were peculiarities of the UK situation—such as geological conditions, housing and heating system design or climate—that meant the technology would not perform as well as reported elsewhere [81]. Although behavioral factors had some impact this was not sufficient to explain the wide range in performance. A further detailed technical study was carried out by DECC and the monitoring contractors in the following year with the aim of identifying faults and sensitivity to variations in design and installation practice [70]. Technical issues were identified with particular sites that were the most likely causes of poor performance. Some of these issues were factors in multiple sites. The technical issues identified can be grouped—in roughly descending order of likely impact on efficiency—as follows [71]:

- (1) Under-sizing of the heat pump;
- (2) Under-sizing of the ground heat exchanger;
- (3) Poor insulation standards (pipes and tanks);
- (4) Flow temperature unnecessarily high;
- (5) Excessive pump usage (time control or number of pumps);
- (6) Poor control.

The most noticeable and recurring consequence of under-sizing of either the heat pump in relation to space heating demand or under-sizing the ground loop was excessive use (without the user being

aware) of supplementary electric resistance heating—either built into the heat pump equipment or a separate tank immersion heater. The similar but smaller-scale study in Harrogate highlighted poor control as the most likely technical cause of poor performance [76].

Some of the problems enumerated above had been largely avoided in the first projects in small social housing projects with the “heatplant” package discussed earlier [37]. In these systems, the heat pump capacity was well matched to the design heating loads of the houses in question. This meant developing a new heat pump with a capacity that was noticeably lower (3.5 kW and later 5 kW) than equipment available from other parts of Europe at the time. The ground loop in these installations was sized rather conservatively. Excessive use of electric heating was avoided as no “cassette” electric heat was built into the heat pump or included elsewhere in the heating circuit. The heat pump had been designed to operate in dual mode and deliver hot water at 65 °C so that resistance heating of the hot water tank was not usually necessary. Although these systems used radiators, retrofit of insulation in many cases meant that they could be generously sized. Controls were very similar to the two-channel devices familiar in UK gas fired boiler systems and, by relying on a room sensor, achieved closed-loop control and so some minimization of flow temperatures according to variations in both climate and user behavior.

3.1. Technical Performance

Gleeson and Lowe [59] attempted to systematically compare the first phase EST field trial data with efficiencies reported in other European countries but faced some difficulty due to the differing system boundaries adopted in different trials. (The UK data was inevitably lower due to the large system boundary than adopted elsewhere). One set of Swedish data [82] from systems retrofit in older homes reported SPF_{H4} values in a similar range to those in the UK trials (a mean of 2.6 and range 2.4–2.9) but most trials, even after allowances for differences in system boundaries were considered, indicated noticeably better efficiencies were being achieved elsewhere in western Europe. One comparable Danish field trial of 138 GSHP in a mix of new and retrofit installations [83], reported a mean SPF_{H4} value of 3.03 being achieved. A 2010 Swedish trial [84] reported results in terms of SPF_{H3} with a mean value of 3.26 and range of 2.6–3.6. Higher values have been reported for a survey of retrofit installations in 36 German homes [85]: a mean SPF_{H3} of 3.88 and range 3.1–5.1. The highest SPF_{H4} values were reported in a trial of installations in 56 new German homes [86] where a mean of 3.75 was found. The low performance reported in the first phase EST trials led to Gleeson and Lowe [59] suggesting the outlook for carbon reduction from heat pump installation in the UK was uncertain.

Taken together, the European field trials considered by Gleeson and Lowe [59] showed that features found to broadly correlate with good performance were: (i) low temperature heat emitters; (ii) capacity chosen to minimize resistance heating, and; (iii) a higher proportion of space heating demand compared to hot water demand. This has been largely confirmed in the detailed analysis of the UK field trial data [71] that led to new rules being established for system capacity and heat emitter selection [72] (see Section 3.2). Improvements due to these revised standards should be reflected (not all systems were implemented after the change in standards) in the later field trial and RHPP data and some progress towards European performance levels is evident. For example, the mean SPF_{H4} value of approximately 3 shown in the RHPP data (see Figure 8) is similar to that in the Danish trials

(3.03) [59,83]. Nevertheless, the higher seasonal performances reported in the German trials suggests there is room for further improvement in the UK context.

Some authors have suggested that “poor quality” installation and building construction (in relation to the best European standards) have been to blame [81]. It is clear that building fabric insulation levels and airtightness have a direct relationship to absolute capacity requirements. However, it is less clear how this affects the ratio of heat output to power input. Gleeson and Lowe examined this issue briefly and compared home heating demands in the different trials on a unit area basis. In the German trials of new housing installations heating demands varied between 85 kWh/m²/year and 340 kWh/m²/year [59]. This range overlaps with that typical in UK housing (mean of 90 kWh/m²/year in 2004). This is a reflection of the fact that, although UK insulation standards are lower, the climate is also milder than either Scandinavia or Germany. Consequently, it is hard to see “poorer insulation” as a significant issue in itself.

3.2. Standards Development

One of the main outcomes of the first phase EST field trial [71] was the identification of a need for better heat pump installer training, installation standards and design guidance adapted for the UK context. DECC established a working committee, drawn from the heat pump industry, to address many of the issues surrounding design and installation of domestic heat pump systems. This led to revision of the MCS GSHP installation standard MICS 3005 [72] and production of supplementary standards and guidance on ground heat exchanger sizing [87], heat emitter selection [88] and hydraulic design [89]. The standards relating to heat pump sizing and heat emitter selection are common to both ASHPs and GSHPs. Development of the standards was supported by separate technical studies of the effects of thermostatic radiator valves [90], buffer tanks and cycling behavior [91]. The installation standards seek to address the problems of excessive use of electric backup heating, poor ground heat exchanger design, unnecessarily high temperatures and excessive pump energy use that were identified in the detailed analysis of the field trial data and enumerated above.

Revision of the MCS heat pump installation standard (MIS 3005 version 3.1) [72] introduced a requirement to match the heat pump capacity to 100% of the house design heat loss (for mono-energetic systems). This is a rather different approach to that taken in other parts of Europe where common practice is to size to allow the final 10%–20% of peak load to be met by electrical resistance heating. The latter practice can be more optimal in terms of capital cost and not very damaging to running costs if the number of hours in the year when peak loads are approached is small. The relationship between heat pump capacity and design load depends on how loads are calculated and the design temperatures chosen. In the revised UK standard 99th percentile coldest temperatures from typical year climate data are defined and so, arguably, there may be short periods where heat pump capacity is exceeded. The argument for taking this conservative approach is that it is simply defined and also robust given the uncertainties in heating load calculation and given that any resistance heating use is very detrimental to carbon efficiency because of the UK’s relatively high electricity carbon factor.

Evidence that ground heat exchangers were too small also emerged from the national field trials. For some time there had been a concern that there may not have been any (domestic) sizing tools

available to GSHP installers that had been specifically evolved for the UK. Whilst generic sizing software such as EED [92], GLHEPro [93] and GLD [94] had been available and quite capable of generating suitable design data given appropriate input of local ground properties, these were largely beyond the reach of many small domestic installers operating under the UK MCS scheme, whether in terms of cost, or complexity. Several of the European heat pump manufacturers were offering their own dedicated software, but it was not clear whether this had been checked or modified for UK conditions. The other European standard that was in existence is VDI-4640 [95], but there were also concerns as to whether this was applicable to all locations in the UK, or met with newly specified UK design requirements.

For ground heat exchanger sizing it was decided to develop a paper based (*i.e.*, non-software) methodology that would cover boreholes, horizontal EU style collectors and Slinkies, for sizes up to 45 kW [96]. The adoption of a non-software approach avoids the issue of trying to support different operating systems on different proprietary software, all at different version levels. The methodology was designed to cover all UK climate and geological conditions, ranging from the Scottish off-islands to as far south as the Isles of Scilly. The philosophy that has been adopted is that, provided an installer follows this sizing methodology, a conservative GSHP design should result. For installers that have better “knowledge” and/or access to other recognized tools, it is possible that more cost-effective designs can be developed. The tables were developed using GLHEPro [93] and EED [92] for boreholes, and CLGS [97] and GLD for horizontal and Slinky systems. The outcomes were cross-checked with VDI-4640 [95], and a few cases of heat pump manufacturers’ software. In the final manifestation, three sets of tables are available (boreholes, horizontal pipe, Slinkies) for the range 1200–3600 of full load equivalent operating hours. Each graph in the standard provides ground extraction thermal capacity plotted against ground equilibrium temperature, and ground thermal conductivity. For the three different types of ground heat exchanger, the configuration is defined in some detail, e.g., borehole spacing, pipe diameters, trench spacing *etc.*

Excessive circulating pump energy demands were identified, in certain monitored systems, of significantly undermining energy performance [64,71]. This was a combination of excessive pump size, poor or non-existent hydraulic design of the ground loop array and also poor control of the running period. The problem of excessive pump power was partly addressed by the requirement introduced into the MCS installation standard [72] that pump power should not exceed 3% of the heat pump’s thermal capacity. This was intended to encourage better hydraulic design and selection of efficient pumps. Design guidance on hydraulic performance was also incorporated into the standards by providing engineering data in graphical form for a range of pipe sizes and different anti-freeze fluids. A flow chart based approach to hydraulic design is provided, based around the pressure drop values given in the tables. By simple iteration it is possible to arrive at a ground loop layout that achieves turbulent flow in the active ground loop elements whilst minimizing circulating pump power, and also meeting the MCS target for the additional parasitic energy. The design methodology and pressure drop tables are also provided [89] as an addendum to the MCS Heat Installation Standard [72].

Pump energy demands are also a function of the length of time they are made to run. The RHPP data showed that faulty circulating pump operation (or poor control design) continued to be an issue. DECC engineers accordingly devoted some effort to automatically detecting pump operation and identifying problem systems by analyzing the streams of monitoring data. They took a similar

approach to analyzing hot water production demands. Although the fault detection algorithms no doubt need further development, making intelligent use of performance and energy data could address some of the variations in performance levels that persist in the recent data (e.g., sites shown in the lower quartile of Figure 7). Carrying out fault detection and diagnosis by remote data collection is very challenging as installation of additional monitoring equipment has shown to be highly error prone (a high proportion of monitoring equipment in the RHPP was found not to comply with the specification and resulted in rejection of the data) but also requires handling and processing of large amounts of data [47]. We suggest that a useful approach would be for heat pump equipment to include factory-installed monitoring equipment and to have local data processing and fault diagnosis capabilities. Such approaches (along with automated commissioning) are taken in some non-domestic heating and cooling equipment [98] and have been shown to be applicable to domestic heat pumps [99] but with an emphasis on running faults rather than energy performance. This functionality may also enable better after-installation care on the part of installers/suppliers—something user surveys have highlighted as needing improvement—and may also improve user confidence.

3.3. System Dynamics and Control

One of the noticeable differences between the sample of GSHP in German new houses [86] noted earlier and discussed by Gleeson and Lowe [59], and those in the UK field trials are the total floor areas. The floor areas in the German sample ranged from 90 m² to 360 m² with a mean value of 189 m². This is noticeably larger than the 91 m² average of the UK properties. As the UK field trials included a number of relatively small social housing properties that had been retrofitted with GSHP, a significant number of properties had floor areas smaller than the national average. Small floor area has a number of implications in terms of system design and building thermal behavior. Small property size (either in terms of floor area or perimeter) tends to mean that domestic hot water demand is a higher proportion of the whole *i.e.*, the heat pump will operate for a large proportion of running hours with high delivery temperatures. It also means that heat emitters tend to be radiators as under-floor heating has a limited specific output and heat losses are more proportional to perimeter length rather than floor area. Having said this, it should be noted that there were some properties in the UK field trials that were small retrofit projects with radiators that performed relatively well.

A further point of difference between some of the UK properties in the heat pump trials and those in other parts of Europe was the relatively high thermal mass of the traditional wall construction. Boait *et al.* [76] pointed out, in their study of small social housing properties in Harrogate, that the masonry construction results in a noticeably higher thermal time constant and this has implications for the design of the heating system controls. This generally makes the control problem more challenging but also gives rise to energy savings opportunities where night set-back operation is introduced [76]. These energy saving opportunities are missed if users are told to operate the system continuously.

A further consequence of property size being relatively small is that casual heat gains associated with occupant activity (e.g., operating appliances) are more significant in relation to the system capacity. Similarly, the action of opening a door or window introduces instantaneous heat losses that are more significant than in a larger property—the most modern and efficient of which are likely to have mechanical ventilation and heat recovery and so lower and more constant ventilation heat losses.

The control systems in the houses of the Harrogate study used an open-loop principle where heating output was adjusted in response to the return heating water temperature and did not have any form of room sensor (the particular Swedish heat pump manufacturer's normal recommendation). In situations where a casual heat gain causes local and short term overheating, where users have been instructed to leave the heat pump running continuously, and where the control system is not responsive, users must resort to opening windows to reduce the temperature but at the expense of unnecessary heat loss. This form of response to overheating seems to be reflected in the RHPP programme user behavior noted above in relation to Figure 8, in that opening doors and windows in response to overheating was much more common among users of GSHP systems than users of biomass boilers. It should be noted that not all the GSHP systems in the trials had the same form of open-loop control as in the Harrogate study. Some did incorporate room sensors and some of these are known by the authors to be among the systems that performed well, but, as control system type or strategy was not systematically reported or studied in the trials, it is difficult to draw firm conclusions. The issue of variation in technical performance of the control systems is also conflated with the dissatisfaction amongst a significant number of users with the operating instructions/training provided [73]. We consequently suggest that there is scope for further research into the optimal form of heat pump system control in the UK context—possibly relying on more intelligent algorithms but also offering interfaces that are more intuitive to users.

A further technical issue related to system control is that of dynamic cycling behavior of heat pumps and the application of buffer tanks [91]. In domestic heat pumps the predominant capacity control mechanism is simple cyclic switching of the compressor. When the heat pump is at rest, refrigerant pressures tend to equalize and the lubricating oil tends to settle. Consequently, in the dynamic start-up phases of operation the system operates inefficiently until the proper pressures are established and the compressor runs with less than ideal lubricating conditions. If cycling is excessive (in terms of cycle duration or a high number of cycles per hour) this results in a deterioration of SPF but also some concern as to reduced compressor life. One approach to maximizing cycle times is to include a buffer tank at the outlet of the heat pump from which the heating system draws warm fluid as demanded and to which the heat pump adds heat according to tank temperature. It is evident from the UK trials that industry practice as to the inclusion of buffer tanks varies considerably. The value of configuring the heating system in this way, and the relationship to TRV operation, was investigated following the first phase of the UK field trials in a combined modeling and experimental study [100]. This study showed that operation of TRVs in systems with small numbers of radiators could exacerbate frequent cycling in some situations and that a small buffer tank could be beneficial. Higher frequency cycling was shown to result in modest reductions in system efficiency. A further benefit of buffer tanks is that it allows more flexible design of the heating system control strategy in that the output of the heat pump is separated from the operating temperature and flow (e.g., circulating pump operation) of the heating distribution system. The use of buffer tanks is therefore an issue that bares further investigation in the context of optimal control.

An alternative approach to capacity control is to vary the speed of the compressor—sometimes referred to as inverter control. This approach is more expensive (in terms of the heat pump package) than simple cyclic controls but in other unitary refrigeration equipment has met with successful efficiency improvements. However, this technology has not penetrated the UK domestic GSHP heat

pump to any noticeable extent, unlike the ASHP market where inverter models are more prevalent. Wider exploitation of inverter drive technology could also help in a UK context in that it should enable lower start-up currents [4] but may require further development to ensure presentation of better harmonic characteristics to the power grid [101].

4. Discussion

Policy measures supporting the uptake of renewable energy technologies usually take the form of packages that include a balance of capital grants, tariff mechanisms, quotas, public procurement and mandatory regulation [102]. A particular feature of the UK microgeneration support strategy is the various forms of supplier obligation programmes that have operated through energy supply companies. Although only a small portion of the programme funds have been directed to GSHP installations they have, nevertheless, represented a significant source of funding for the industry. These programmes have been particularly beneficial in funding larger-scale social housing projects. Registered Social Landlord clients could continue to be an important sector of the domestic GSHP market but, as current support programmes are very market oriented, the industry faces increasing competition from ASHPs in this sector.

The most recent form of supplier obligation scheme is the Energy Company Obligation (ECO). This scheme has not, to date, resulted in the same opportunities for GSHP installers or promoted renewable technologies to the same extent as the earlier CERT programme. The scheme, in view of the fact that the costs are visibly added to consumer energy bills, has been subject to political pressures and has recently been cut back by one third [103]. The scheme currently focuses on domestic insulation provision (with emphasis on social housing) and has introduced funding for district heating connections. Although this emphasis is arguably well founded in terms of marginal cost and marginal carbon reduction it can be seen, nevertheless, as a missed opportunity for support of geothermal heat pump uptake. Funding for larger-scale social housing projects that include GSHP may require RSLs to resort to more innovative funding mechanisms.

The current UK government has introduced a marked swing from historic energy efficiency policy towards a strongly market-based approach [18]. Since the end of the RHPP programme, capital grants have stopped and support will rely on a renewable heat tariff mechanism (the RHI). Capital support for GSHP and other renewable technologies will be available to householders through the UKs "Green Deal" programme which provides up-front capital loans rather than grants and these are repaid through the homeowners' energy bills [104]. In this scheme, the technical suitability of a particular energy efficiency or renewable technology measure is ranked according to the results of an individual property energy assessment and the costs are offset by renewable heat or feed-in tariff payments over the life of the system. No significant data is currently available to indicate the success or failure of this novel approach. This approach is clearly highly sensitive to individual attitudes, for example, attitudes to debt, likely energy costs and the individual's long-term property ownership plan. At the time of writing we must conclude that the level of support for GSHP installations that may come from these programmes is highly uncertain.

It is, perhaps, surprising that there is little evidence that the UK Building Regulations [105] that determine allowable levels of energy efficiency and carbon emission rates have not had any impact on

the uptake of domestic GSHP technology—in spite of the higher standards that have been prompted by the EU Energy Performance of Buildings Directive (EPBD). Essentially domestic building designers are still able to show compliance by suitable choice of insulation and inclusion of a condensing gas boiler. There has been limited uptake of solar thermal technology in the new building stock provided by large-scale suppliers but no other renewable technologies. Small developments and individually commissioned properties seem to be the only exceptions and are relatively few in number. That new houses be “zero carbon” (zero carbon is defined with respect to installed heating, hot water and lighting demands in this context.) by 2016 has been a stated UK policy for some time. Two sets of standards have been developed by government in the interest of moving energy performance in this direction: the mandatory Building Regulations—which are to be revised again in 2016—and a set of voluntary standards known as the Code for Sustainable Homes (CSH) that are aspirational and go beyond the mandatory standards [106]. These latter standards could be adopted by individual contractors voluntarily but also specified as an additional planning requirement by local authorities—a power granted under the Planning and Energy Act 2008.

The higher-level CSH standards (code levels 5 and 6) require, in practice, that renewable technology be deployed in some form [107]. If the mandatory Building Regulations were to enforce the energy/carbon efficiency standards set out in the higher levels of the CSH when they are revised in 2016, this may force an increased rate of uptake of a range of renewable heat technologies including GSHP. However, recent UK government consultation (led by the Department of Communities and Local Government, DCLG rather than the DECC) that has been notionally motivated by a desire for simplification of regulation has changed expectations. It is consequently proposed to have a regulatory regime focused entirely on the building regulations and eliminate the CSH standards [108]. It is further proposed to repeal the provisions of the Planning and Energy Act 2008 so that local authorities are no longer able to insist on higher energy performance standards or levels of renewable energy deployment (a change of possibly greater significance in the non-domestic GSHP sector). Housing developers may furthermore be given the option to invest in off-site renewable energy sources rather than integrate renewable technologies into the house design to show compliance with the “zero carbon” requirement. At this point it is unclear what these proposals may amount to in house design trends but, if such proposals are adopted, it could be a missed opportunity to drive further uptake of renewable technologies.

Renewable energy policy in the UK has firstly been set out with a 2020 milestone in mind [28]. This has been mostly driven by the timeline set out in the EU RES directive that has prompted policies concerned specifically with renewable heating for the first time. Following the national binding targets for long term carbon emissions reduction introduced by the Climate Change Act 2008, policy and planning (for all sectors) has focused on 2030 and 2050 milestones. Policy advice and setting and monitoring of targets have become the responsibility of the independent Committee on Climate Change (CCC) who initially set out four carbon budgets for the years up to 2027 [109]. Recent carbon reduction and energy supply planning has also turned to 2030 and 2050 timeframes [110]. Much of this planning and the underlying modeling is based on the electricity grid being steadily decarbonized and provision of heat moving from fossil fuels to electrically driven heat pumps. The current CCC “medium abatement” scenario is for 6.8 million heat pumps to be in use by 2030 [109]. This is predicated on heat pumps being a competitive and consumer-appealing technology after 2030 so that the majority of new homes have heat pumps.

The optimism of this view of long-term heat pump deployment was reflected in the national renewable energy strategy published in 2009 but with respect to the 2020 milestone. These proposals formed the basis of the UK National Renewable Energy Action Plan (NREAP) submitted to the European Commission in response to the requirements of the RES directive in 2010 [111]. The UK NREAP makes a commitment to deployment of GSHPs that is derived from a projection of 330,000 units being installed by 2020 [112]. This estimated deployment appears to be based on an installation growth rate of slightly more than 50% per year leading up to 2020. Domestic GSHP installations were expected to mostly occur in the off-gas-grid and new housing sectors and financial support was expected to be at a similar level to that of the CERT programme. Since the NREAP was submitted in 2010, circumstances have changed considerably in that the economic downturn has severely limited new house building and the nascent UK heat pump industry capacity has faltered. Furthermore, it is clear that the ECO supplier obligation scheme will not provide the support for GSHP installations that CERT did [42,43]. Consequently it is hard to see that either the new housing market will have developed or industry capacity grown to the levels reflected in the UK NREAP. Poor progress along the trajectory set out in the plan was pointed out in the most recent report on the EurObserve'ER data [13]. The renewable thermal energy contribution from geothermal heat in 2012 was reported to be 23 ktoe, which is significantly lower than the 174 ktoe target for 2012 included in the UK's NREAP [111].

Deployment of GSHP systems under the RHPP programme focused on off-gas-grid retrofit applications. Where existing electrical resistance heating was replaced by heat pumps (either ASHP or GSHP) there has been no evidence of detrimental impact on local power distribution networks. However, in most of the UK's long term carbon/energy transition plans (2030 and 2050 timeframes) electrification of heating by large scale uptake of heat pumps is seen as a key element [113] and so impact on the national power grid and demand profiles is a genuine concern [114]. Incorporating large numbers of heat pumps into the UK power distribution system has to be seen in the context of many factors that are driving change and innovation in the UK power generation and distribution industry and alongside wider scale distributed generation (e.g., domestic PV) and adoption of electric vehicles [114]. Whole system national modeling studies [110] have shown that heat pumps can play an important role in facilitating demand management in that they offer opportunities for energy storage [110]. It therefore seems important that the heat pump industry is responsive to this requirement and enables intelligent interaction between the grid and heat pump installations and designs heating systems that include appropriate levels of thermal storage [115].

5. Conclusions

Deployment of domestic geothermal heat pumps in the UK has grown from a handful of systems installed in the late 1990s to approaching 18,000 at the time of writing. The industry has passed through an embryonic stage until 2003 and has grown approximately linearly in the 2003–2013 period with the support of a variety of grant programmes. The UK's adoption of domestic GSHP technology has lagged that of many other EU countries which is mostly a reflection of the well developed gas grid and consumer preference for high temperature hydronic heating and hot water generation. The dominance of gas fueled heating is reflected in the national skills base and consumer awareness.

Some of the barriers to deployment of GSHPs have been addressed by the technology being promoted through a national microgeneration grant programme that has disseminated information and initiated the development of installation standards and product certification. The industry has been able to organize and represent itself through the formation of a national trade association that is active in standards and training development as well as dissemination of information.

Support programmes that have been either focused on householders or have operated on a larger scale through energy supplier obligations have provided funding for over half of the domestic GSHP installations to date. However, funding of installations outside of the support programmes has dropped significantly during the recent economic downturn. We suggest, therefore, that the industry has yet to reach a stage of firm and sustainable growth and remains highly dependent on support programmes. In the near future (2014–2017) this will only be the tariff-based Renewable Heat Incentive and associated Green Deal programmes, the success of which—in that this market-based approach is sensitive to consumer attitudes, market conditions and fuel price changes—is highly uncertain.

Our review of data produced by earlier energy supplier obligation programmes shows that they have been very effective in providing support for GSHP installations and assisting in growth of the industry. GSHPs installed in the social housing projects funded through the supplier obligation programmes have made a contribution to alleviating fuel poverty. Supplier obligation programmes have supported the installation of approximately twice the number of heat pumps as the householder grant programmes although the latter have probably been more successful in promoting the technology and providing consumer information.

The UK has operated a series of relatively large-scale national heat pump field trials. These initially indicated the industry was delivering too many installations that were performing poorly relative to efficiency levels reported in other European countries. The trials have provided good evidence for the development of improved installation standards and given some insight into the technical issues that were not being addressed consistently. The most recent monitoring data shows that performance has been improved such that there can be high confidence that GSHP can contribute real carbon emission savings and running cost reductions. Average seasonal efficiencies are still short of the best European standards. We have identified a number of areas where technical improvements could be made and highlighted the need for further research into control of heat pumps in small houses with high thermal mass that are typical of the UK retrofit market. Research that has drawn on UK user responses has shown there is a need for users to receive better information about system operation and for control systems that are more intuitive.

UK carbon emissions reduction and renewable energy plans are based on electrification of the domestic heat sector through the adoption of heat pumps. The long-term prospects for GSHP adoption are, on the face of it, very favorable. However, progress with extensive adoption of heat pumps through the 2020s, when the electricity grid should have made some progress towards decarbonization, is dependent on having a sustainable installation industry that is considerably larger than now exists. It will correspondingly be important that the installation industry is sufficiently supported in the years approaching 2020 that both consumer and investor confidence grows. The absence of a supportive supplier obligation scheme makes growth in the run-up to 2020 very difficult to predict. The failure to show year-on-year increases in the rate of installation means that matching the levels of deployment envisaged in the UK NREAP will make the obligations of the RES directive very difficult to meet.

We suggest that progress towards sustainable growth in the GSHP industry before 2020 may not be possible without further regulatory measures implemented through vehicles such as the Building Regulations or the type of explicit directives that have ensured uptake of condensing boilers and fluorescent domestic lighting in the recent past. This need for regulatory measures to provide sufficient assurance of long-term growth was highlighted in the detailed bottom-up modeling prepared for the CCC [113]. One regulatory measure that could be considered would be to follow the example of the Swedish building regulation implemented in 1984 that required all new heating systems to be designed to operate at low temperature (55 °C) [116]. This opened a path for later deployment of heat pumps in Sweden when the technology became more consumer-appealing and cost effective. This measure would have little cost impact in well-insulated homes in the UK, where radiator sizes are small in any case, and would also benefit condensing boiler operation in the medium term.

Although the new RHI programme payments for renewable heat from GSHPs will go some way to leveling the playing field in terms of financial payback, and there are opportunities in the off-gas-grid sector, GSHP technology will face strong competition from ASHPs. Although social housing development has played a significant role in the growth of the GSHP industry, recent evidence suggests there may be an increasing preference for ASHPs amongst such developers [78]. Recent grant uptake also suggests that larger new up-market housing may play a more significant role in the domestic GSHP market. For GSHP technology to be appealing to home owners and developers the industry will need to demonstrate that higher efficiencies can be consistently assured and make progress in reducing the capital costs and complexities (both technical and contractual) associated with ground heat exchanger installation. Technology such as automated monitoring and fault detection may assist in ensuring consistent performance. However, achieving higher levels of efficiency, lower fault levels and higher consumer satisfaction at the same time as industry growth, will require more comprehensive and better integrated industry training to be fully established and standards to be consistently met.

Acknowledgments

The authors wish to thank Chris Wickins of the Department of Energy and Climate Change for his helpful comments during the preparation of this paper. We would also like to thank Tom Pine of GeoScience for his assistance with the installation data.

Author Contributions

Simon Rees was responsible for the primary analysis of the market and support programme data. He carried out the review of the national field trials and non-technical data. Robin Curtis provided background information regarding historical development of the GSHP installation industry and was responsible for part of the content relating to technical developments. Robin Curtis provided material relating to installation standards development.

Conflicts of Interest

The authors declare no conflict of interest

References

1. Lund, J.; Freeston, D.; Boyd, T. Direct utilization of geothermal energy 2010 worldwide review. *Geothermics* **2011**, *40*, 159–180.
2. Baker, W. *Off-Gas Consumers Information on Households Without Mains Gas Heating*; Consumer Focus: London, UK, 2013; p. 54.
3. Bayer, P.; Saner, D.; Bolay, S.; Rybach, L.; Blum, P. Greenhouse gas emission savings of ground source heat pump systems in Europe: A review. *Renew. Sustain. Energy Rev.* **2012**, *16*, 1256–1267.
4. Singh, H.; Muetze, A.; Eames, P. Factors influencing the uptake of heat pump technology by the UK domestic sector. *Renew. Energy* **2010**, *35*, 873–878.
5. Lund, J.; Freeston, D.; Boyd, T. Direct application of geothermal energy: 2005 worldwide review. *Geothermics* **2005**, *34*, 691–727.
6. Garnish, J.D. Geothermal Resources of the UK—Country Update Report. *Trans. Geotherm. Resour. Counc.* **1985**, *9 International*, 217–222.
7. Sumner, J.A. *Domestic Heat Pumps*; Prism Press: London, UK, 1976.
8. Curtis, R. Earth Energy in the UK. *Geo Heat Cent. Bull.* **2001**, 23–30.
9. Lund, J.; Freeston, D. World-wide direct uses of geothermal energy 2000. *Geothermics* **2001**, *30*, 29–68.
10. Batchelor, T.; Curtis, R.; Ledingham, P. Country update for the United Kingdom. In Proceedings of World Geothermal Congress 2005, Antalya, Turkey, 24–29 April 2005; pp. 1–5.
11. Karpathy, B.Z. *Heat Pumps United Kingdom World Renewables 2013 A Multi Client Study*; BSRIA: Bracknell, UK, 2013.
12. EurObserv'ER. Ground-Source Heat Pump Barometer. *J. Des Énergies Renouv.* **2011**, *205*, 82–101.
13. EurObserv'ER. *Heat Pumps Barometer*; EurObsv'ER: Brussels, Belgium, 2013; p. 17.
14. Curtis, R.; Ledingham, P.; Law, R.; Bennett, T. Geothermal Energy Use, Country Update for United Kingdom. In Proceedings of European Geothermal Congress 2013, Pisa, Italy, 3–7 June 2013; pp. 1–9.
15. Fawcett, T. The future role of heat pumps in the domestic sector. In Proceedings of the ECEEE 2011 Summer Study, Energy Efficiency First: The Foundation of a Low-Carbon Society, Belambra Presqu' île de Giens, City, France, 6–11 June 2011; pp. 1547–1557.
16. Le Feuvre, P. *An Investigation into Ground Source Heat Pump Technology, its UK Market and Best Practice in System Design*. Master's Thesis, Univeristy of Strathclyde, Glasgow, UK, 2007, p. 180.
17. *Outlook 2009 European Heat Pump Statistics*; European Heat Pump Association: Brussel, Belgium, 2009; p. 39.
18. Mallaburn, P.; Eyre, N. Lessons from energy efficiency policy and programmes in the UK from 1973 to 2013. *Energy Effic.* **2014**, *7*, 23–41.
19. Department of the Environment. *This Common Inheritance: Britain's Environmental Strategy*; HMSO: London, UK, 1990; p. 291.

20. Performance Innovation Unit. *The Energy Review*; Cabinet Office Performance and Innovation Unit: London, UK, 2002; p. 216.
21. Department of Trade and Industry (DTI). *Our Energy Future—Creating a Low Carbon Economy*; DTI: London, UK, 2003; p. 142.
22. BRE. Renewable energy grants top £5.5 million. Available online: <http://www.bre.co.uk/news/Renewable-energy-grants-top-55-million-230.html> (accessed on 12 June 2014).
23. BRECSU. *Heat Pumps in the UK—A Monitoring Report (GIR 72)*; BRECSU: Watford, UK, 2000; p. 16.
24. Van de Ven, H. Ground-source heat pump systems, An international overview. *IEA Heat Pump Cent. Newsl.* **1999**, *17*, 10–12.
25. HMG. *Energy Act 2004*; HM Government: London, UK, 2004; p. 296.
26. Gardiner, M.; White, H.; Munziger, M.; Ray, W. *Low Carbon Building Programme 2006–2011 Final Report*; Department of Energy and Climate Change: London, UK, 2011; p. 169.
27. Radov, D.; Klevnä, P.; Lindovska, M. Design of the Renewable Heat Incentive Study for the Department of Energy & Climate Change. NERA Economic Consulting: London, UK, 2010; p. 69.
28. HMG. *The UK Renewable Energy Strategy*; HM Government: London, UK, 2009; p. 236.
29. OFGEM. Domestic Renewable Heat Incentive. Available online: <https://www.ofgem.gov.uk/environmental-programmes/domestic-renewable-heat-incentive> (accessed on 12 June 2014).
30. Barker, G. *Departmental Note: Support for Renewable Heat Technologies in the Domestic and non-Domestic Sectors*; Department of Energy and Climate Change: London, UK, 2013; p. 1.
31. Department of Energy and Climate Change (DECC). *Renewable Heat Incentive, Consultation on Proposals for a Domestic Scheme*; DECC: London, UK, 2012; p. 32.
32. Rosenow, J. Energy savings obligations in the UK—A history of change. *Energy Policy* **2012**, *49*, 373–382.
33. Office of Gas and Electricity Markets (OFGEM). *A Review of the Energy Efficiency Commitment 2002–2005*; OFGEM: London, UK, 2005; p. 83.
34. Office of Gas and Electricity Markets (OFGEM). *A Review of the Energy Efficiency Commitment 2005–2008*; OFGEM: London, UK, 2008; p. 62.
35. Department of the Environment, Transport and the Regions (DETR). *Quality and Choice: A Decent Home for All: The Housing Green Paper*; DETR: London, UK, 2000; p. 132.
36. Dewdney, P. Powergen Enters New Era of Low-Cost, Low-Carbon Heating. Available online: <http://www.heatpumps.org.uk/CaseExDomestic.html> (accessed on 18 August 2014).
37. Calorex. *Case Study, Ground Source Heat Pumps Cutting Carbon Emissions*; Calorex Ltd.: Maldon, Essex, UK, 2007; pp. 16–17.
38. BBC. Hot Earth to Heat Homes. Available online: <http://news.bbc.co.uk/1/hi/england/1670092.stm> (accessed on 12 June 2014).
39. Hill, D. Ground Sourced Heat Pumps, Our experiences and where to next. In *GSHPA Seminar, 2005*; GSHPA: Milton Keynes, UK, 2005; pp. 1–3.
40. BRE. *Ground Source Heat Pumps Case Study*; BRE: Watford, UK, 2004; pp. 1–4.
41. Calorex. *Calorex Case Study—Housing*; Calorex Ltd.: Maldon, Essex, UK, 2006; p. 1.

42. Office of Gas and Electricity Markets (OFGEM). *A Review of the Fourth Year of the Carbon Emissions Reduction Target*; OFGEM: London, UK, 2012; p. 55.
43. Office of Gas and Electricity Markets (OFGEM). Energy Companies Obligation (ECO). Available online: <https://www.ofgem.gov.uk/environmental-programmes/energy-companies-obligation-eco> (accessed on 12 June 2014).
44. Energy Savings Trust (EST). *Element Energy Potential for Microgeneration, Study and Analysis Final Report*; EST: London, UK, 2005.
45. Caird, S.; Potter, S.; Herring, H. *Consumer Adoption and Use of Household Renewable Energy Technologies, Report DIG-10*; The Open University: Milton Keynes, UK, 2007; p. 57.
46. Balcombe, P.; Rigby, D.; Azapagic, A. Motivations and barriers associated with adopting microgeneration energy technologies in the UK. *Renew. Sustain. Energy Rev.* **2013**, *22*, 655–666.
47. Wickins, C. *Preliminary Data from the RHPP Heat Pump Metering Programme*; Department of Energy and Climate Change: London, UK, 2014; p. 61.
48. Karpathy, Z. *Heat Pump Markets UK in Europe*; BSRIA: Bracknell, UK, 2012.
49. DECC. *Low Carbon Building Programme Householder's Project Case Study—Ground Source Heat Pump*; Department for Communities and Local Government: London, UK, 2010; p. 4.
50. NEF. Ground Source Heat Pump Association Comes of Age. Available online: <http://www.nef.org.uk/about-us/press-releases/ground-source-heat-pump-association-comes-of-age> (accessed on 9 May 2014).
51. GSHPA. GSHPA press release—Ground Source Heat Pump RHI tariff expected to double. Available online: http://www.gshp.org.uk/pdf/GSHPA_Press_Release_24_January_2013.pdf (accessed on 12 May 2014).
52. Microgeneration Certification Scheme (MCS). *History of the Microgeneration Certification Scheme*; MCS: Watford, UK, 2013; p. 5.
53. European Certified Heat Pump Installer. Available online: http://www.heatpumpcentre.org/en/newsletter/previous/Documents/HPC-news_2_2004.htm (accessed on 12 June 2014)
54. BDA. BDA awarded ConstructionSkills grant for Geothermal Drilling. Available online: <http://www.britishdrillingassociation.co.uk/news/BDA-awarded-ConstructionSkills-grant-for-Geothermal-Drilling> (accessed on 12 June 2014).
55. Wincott, N. GeoTrainet and European Wide Training Developments. In *GSHPA Technical Seminar 2013*; GSHPA: Milton Keynes, UK, 2013; p. 24.
56. Brooke, S.B.; Matthews, D.; Willson, C. *UK Literature Review for International Energy Agency (IEA) Annex 36 on Investigating the Effect of Quality of Installation and Maintenance on Heat Pump Performance*; Department of Energy and Climate Change: London, UK, 2013.
57. CEN. *EN 14511-2, Air Conditioners, Liquid Chilling Packages and Heat Pumps with Electrically Driven Compressors for Space Heating and Cooling—Part 2: Test Conditions*; CEN: Brussels, Belgium, 2007.
58. CEN. *EN 15316-4-2, Heating Systems in Buildings—Method for Calculation of System Energy Requirements and System Efficiencies—Part 4-2: Space Heating Generation Systems, Heat Pump Systems*; CEN: Brussels, Belgium, 2008.
59. Gleeson, C.; Lowe, R. Meta-analysis of European heat pump field trial efficiencies. *Energy Build.* **2013**, *66*, 637–647.

60. Stafford, A. Long-term monitoring and performance of ground source heat pumps. *Build. Res. Inf.* **2011**, *39*, 566–573.
61. Wemhorner, C.; Dott, R.; Afjei, T.; Huber, H.; Helfenfinger, D.; Keller, P.; Furter, R. *Calculation Method for the Seasonal Performance of Heat Pump Compact Units and Validation*; Swiss Federal Office of Energy: Bern, Switzerland, 2007.
62. Zottl, A.; Nordman, R.; Rivi ère, P. SEPEMO—Common Monitoring Methodology. *Eur. Heat Pump News* **2011**, *3*, 5–6.
63. European Commission. *Decision (2013/114/EU) Establishing the Guidelines for Member States on Calculating Renewable Energy from Heat Pumps from Different Heat Pump Technologies pursuant to Article 5 of Directive 2009/28/EC of the European Parliament and of the Council*; Official Journal of the European Union: Brussels, Belgium, 2013; pp. 27–35.
64. Dunbabin, P.; Charlick, H.; Green, R. *Detailed Analysis from the Second Phase of the Energy Saving Trust's Heat Pump Field Trial*; Department of Energy and Climate Change: London, UK, 2013; p. 123.
65. Energy Saving Trust (EST). *The Heat is on: Heat Pump Field Trials Phase 2*; EST: London, UK, 2013; p. 40.
66. Greening, B.; Azapagic, A. Domestic heat pumps: Life cycle environmental impacts and potential implications for the UK. *Energy* **2012**, *39*, 205–217.
67. Johnson, E. Air-source heat pump carbon footprints: HFC impacts and comparison to other heat sources. *Energy Policy* **2011**, *39*, 1369–1381.
68. European Commission. *Directive 2009/28/EC of the European Parliament and of the Council of 23 April 2009 on the Promotion of the Use of Energy from Renewable Sources and Amending Subsequently Repealing Directives 2001/77/EC and 2003/30/EC*; Official Journal of the European Union: Brussels, Belgium, 2009; pp. 16–62.
69. Orr, G.; Lelyveld, T.; Burton, S. *Final Report : In-situ Monitoring of Efficiencies of Condensing Boilers and Use of Secondary Heating*; Gastec at CRE: Cheltenham, UK, 2009; p. 44.
70. Energy Saving Trust (EST). *Getting Warmer: A Field Trial of Heat Pumps*; EST: London, UK, 2010.
71. Dunbabin, P.; Wickins, C. *Detailed Analysis from the First Phase of the Energy Saving Trust's Heat Pump Field Trial*; Department of Energy and Climate Change: London, UK, 2012.
72. Microgeneration Certification Scheme (MCS). *Microgeneration Installation Standard: MIS 3005, Requirements for Contractors Undertaking the Supply, Design, Installation, Set to Work Commissioning and Handover of Microgeneration Heat Pump Systems, Version 3.1*; MCS: Watford, UK, 2008; pp. 1–47.
73. Caird, S.; Roy, R.; Potter, S. Domestic heat pumps in the UK: User behaviour, satisfaction and performance. *Energy Effic.* **2012**, *5*, 283–301.
74. Roy, R.; Caird, S. Diffusion, User Experiences and Performance of UK Domestic Heat Pumps. *Energy Sci. Technol.* **2013**, *6*, 14–23.
75. Stafford, A.; Lilley, D. Predicting in situ heat pump performance: An investigation into a single ground-source heat pump system in the context of 10 similar systems. *Energy Build.* **2012**, *49*, 536–541.

76. Boait, P.; Fan, D.; Stafford, A. Performance and control of domestic ground-source heat pumps in retrofit installations. *Energy Build.* **2011**, *43*, 1968–1976.
77. DECC AECOM. *Analysis of Customer Data from Phase One of the Renewable Heat Premium Payments (RHPP) Scheme*; Department of Energy and Climate Change: London, UK, 2013; p. 110.
78. Energy Saving Trust. RHPP RSL Fast Track Competition Winners 2013–2014. Available online: <http://www.energysavingtrust.org.uk/Generating-energy/Getting-money-back/Renewable-Heat-Premium-Payment-RHPP-Social-Landlords-Competition-Phase-Two-Extensions-2013-14/RHPP-RSL-Fast-Track-Competition-Winners-2013-2014> (accessed on 19 May 2014).
79. Office for National Statistics. Home ownership and renting in England and Wales—Detailed Characteristics. Available online: <http://www.ons.gov.uk/ons/rel/census/2011-census/detailed-characteristics-on-housing-for-local-authorities-in-england-and-wales/short-story-on-detailed-characteristics.html> (accessed on 22 June 2014).
80. Office for National Statistics. *Annual Survey of Hours and Earnings, 2013 Provisional Results*; Office for National Statistics: London, UK, 2013; pp. 1–45.
81. Delta Energy & Environment. *Heat Pumps in the UK: How Hot Can They Get?* Delta Energy and Environment: Edinburgh, UK, 2011; p. 8.
82. Stenlund, M.; Axell, M. *Residential Ground-Source Heat Pump Systems—Results from a Field Study in Sweden*; SP Swedish Technical Research Institute: Borås, Sweden, 2007; pp. 1–10.
83. Pederson, S.; Jacobsen, E. *Approval of Systems Entitled to Subsidies. Measurements Data Collection and Dissemination*; Danish Technological Institute: Taastrup, Denmark, 2011; p. 12.
84. Nordman, R.; Andersson, K.; Axell, M.; Lindahl, M. *Calculation Methods for SPF for Heat Pump Systems for Comparison, System Choice and Dimensioning*; SP Swedish Technical Research Institute: Borås, Sweden, 2010; p. 82.
85. Russ, C.; Miara, M.; Platt, M.; Günther, D.; Kramer, T.; Dittmer, H.; Lechner, T.; Kurz, C. *Feldmessung Wärmepumpen im Gebäudebestand*; Fraunhofer ISE: Freiburg, Germany, 2010; pp. 1–21. (In German)
86. Miara, M.; Gunther, D.; Kramer, T.; Oltersdorf, T.; Wapler, J. *Messtechnische Untersuchung von Wärmepumpenanlagen zur Analyse und Bewertung der Effizienz im realen Betrieb*; Fraunhofer ISE: Freiburg, Germany, 2011; p. 154. (In German)
87. Microgeneration Certification Scheme (MCS). *MCS 022: Ground Heat Exchanger Look-up Tables, Supplementary Material to MIS 3005, Issue 1.0*; MCS: Watford, UK, 2011; pp. 1–22.
88. Microgeneration Certification Scheme (MCS). *MCS 021: Heat Emitter Guide for Domestic Heat Pumps, Issue 1.0*; MCS: Watford, UK, 2013; p. 9.
89. GeoEnergy. *MCS Procedure and Charts for Designing the Hydraulics and Associated Pumping Power of Closed Loop GSHP Systems under MCS*; MCS: Watford, UK, 2012; p. 39.
90. Green, R.; Knowles, T. *The Effect of Thermostatic Radiator Valves on Heat Pump Performance*; EA Technology Consulting: Chester, UK, 2011; p. 21.
91. Charlick, H. *Investigation of the Interaction between Hot Water Cylinders, Buffer Tanks and Heat Pumps*; Kiewa GASTEC at CRE: Cheltenham, UK, 2013.
92. Hellström, G.; Sanner, B. Software for dimensioning of deep boreholes for heat extraction. *Proc. CALORSTOCK 1994*, *94*, 195–202.

93. Spitler, J.D. GLHEPRO—A design tool for commercial ground loop heat exchangers. In Proceedings of the Fourth International Heat Pumps in Cold Climates Conference, Aylmer, QC, Canada, 17–18 August 2000; p. 16.
94. Gaia Geothermal LLC. Ground Loop Design User's Guide. Available online: http://www.groundloopdesign.com/downloads/GLD_2.x/manual.pdf (accessed on 21 August 2014).
95. Verein Deutscher Ingenieure. *VDI-Richtlinie 4640: Thermische Nutzung des Untergrundes—Blatt 2: Erdgekoppelte Wärmepumpenanlagen*; Beuth Verlag: Berlin, Germany, 2001.
96. Curtis, R.; Pine, T.; Wickins, C. Development of new ground loop sizing tools for domestic GSHP installations in the UK. In The Proceedings of European Geothermal Congress 2013, Pisa, Italy, 3–7 June 2013; pp. 1–10.
97. International Ground Source Heat Pump Association (IGSHPA). *CLGS Ground Heat Exchanger Design Program*; IGSHPA: Stillwater, OK, USA, 2005.
98. Schein, J.; Bushby, S.T. A hierarchical rule-based fault detection and diagnostic method for HVAC systems. *HVAC&R Res.* **2006**, *12*, 115–126.
99. Zogg, D. Fault Diagnosis for Heat Pump Systems. Ph.D.Thesis, Swiss Federal Institute of Technology (ETH), Zurich, Switzerland, 2002.
100. Curtis, R.; Pine, T. *Effects of Cycling on Domestic GSHPs Supporting Analysis to EA Technology Simulation/Modelling*; Mimer Geoenergy: Falmouth, UK, 2012; p. 28.
101. Heffernan, W.; Watson, N. Harmonic performance of heat-pumps. *J. Eng.* **2013**, *25*, 1–14.
102. Connor, P.; Bürger, V.; Beurskens, L.; Ericsson, K.; Egger, C. Devising renewable heat policy: Overview of support options. *Energy Policy* **2013**, *59*, 3–16.
103. Department of Energy and Climate Change (DECC). *The Future of the Energy Company Obligation*; DECC: London, UK, 2014; p. 63.
104. Department of Energy and Climate Change (DECC). *The Green Deal, A Summary of the Government's Proposals*; DECC: London, UK, 2010; p. 22.
105. HMG. *The Building Regulations, Conservation of Fuel and Power Approved Document Part L1A (2013 version)*; HM Government: London, UK, 2013; p. 48.
106. Department for Communities and Local Government (DCLG). *Code for Sustainable Homes, A Step-Change in Sustainable Home Building Practice*; DCLG: London, UK, 2006; p. 31.
107. Department for Communities and Local Government (DCLG). *The Code for Sustainable Homes, Case Studies Volume 2*; DCLG: London, UK, 2010; Volume 2, p. 50.
108. Department for Communities and Local Government (DCLG). *Housing Standards Review*; DCLG: London, UK, 2013; p. 88.
109. The Committee on Climate Change (CCC). *The Fourth Carbon Budget, Reducing Emissions through the 2020s*; CCC: London, UK, 2010.
110. Strbac, G.; Gan, C.K.; Aunedi, M.; Stanojevic, V.; Djapic, P.; Dejvises, J.; Mancarella, P.; Hawkes, A.; Pudjianto, D.; Openshaw, D.; *et al.* *Benefits of Advanced Smart Metering for Demand Response based Control of Distribution Networks*; Imperial College London: London, UK, 2010; p. 49.
111. Department for Communities and Local Government (DCLG). *National Renewable Energy Action Plan for the United Kingdom*; DCLG: London, UK, 2009; p. 160.

112. Radov, D.; Klevnäs, P.; Lindovska, M.; Abu-Ebid, M.; Barker, N.; Stabaugh, J. *The UK Supply Curve for Renewable Heat*; NERA Economic Consulting: London, UK, 2009; Volume 689, p. 155.
113. Frontier Economics Element Energy. *Pathways to High Penetration of Heat Pumps*; Frontier Economics Ltd.: London, UK, 2013; p. 147.
114. Guzeleva, D. Challenges in the UK network. In *IET Seminar, Integrating Renewable Energy to the Grid: Optimising and Securing the Network*; IET: London, UK, 2014.
115. Sugden, L. Smart Grids create new opportunities for heat pumps. *REHVA J.* **2012**, 20–22.
116. Karlsson, F.; Axell, M.; Fahlén, P. *Heat Pump Systems in Sweden—Country Report for IEA HPP Annex 28*; SP Swedish Technical Research Institute: Borås, Sweden, 2003; pp. 1–29.

© 2014 by the authors; licensee MDPI, Basel, Switzerland. This article is an open access article distributed under the terms and conditions of the Creative Commons Attribution license (<http://creativecommons.org/licenses/by/3.0/>).