

The Impact of Higher Order Pulse Amplitude Modulation and Transmission Performance over Twisted Pair Cable

Katharina Seitz
BEng, MSc

A thesis submitted in partial fulfilment of requirements of
De Montfort University for the degree of Doctor of
Philosophy

De Montfort University
October 2019

Abstract

The digital age makes it possible to be globally networked at any time. Digital communication is therefore an important aspect of today's world. Hence, the further development and expansion of this is becoming increasingly important. Even within a wireless system, copper channels are important as part of the overall network. Given the need to keep pushing at the current limitations, careful design of the cables in connection with an adapted coding of the bits is essential to transmit more and more data.

One of the most popular and widespread cabling technologies is symmetrical copper cabling [1, pp. 8-15]. It is also known as Twisted Pair and it is of immense importance for the cabling of communication networks.

At the time of writing this thesis, data rates of up to 10 GBit/s over a transmission distance of 100 m and 40 GBit/s over a transmission distance of 30 m are standardized for symmetrical copper cabling [2]. Other lengths are not standardized. Short lengths in particular are of great interest for copper cables, because copper cables are usually used for short distances, such as between computers and the campus network or within data centres.

This work has focused on the transmission of higher order Pulse Amplitude Modulation and the associated transmission performance. The central research question is: "how well can we optimize the transmission technique in order to be able to maximise the data bandwidth over Ethernet cable and, given that remote powering is also a significant application of these cables, how much will the resulting heating affect this transmission and what can be done to mitigate that?"

To answer this question, the cable parameters are first examined. A series of spectral measurements, such as Insertion Loss, Return Loss, Near End Crosstalk

and Far End Crosstalk, provide information about the electromagnetic interference and the influence of the ohmic resistance on the signal. Based on these findings, the first theoretical statements and calculations can be made. In the next step, data transmissions over different transmission lengths are realized. The examination of the eye diagrams of the different transmission approaches ultimately provides information about the signal quality of the transmissions. An overview of the maximum transmission rate depending on the transmission distance shows the potential for different applications.

Furthermore, the simultaneous transmission of energy and data is a significant advantage of copper. However, the resulting heat development has an influence on the data transmission. Therefore, the influence of the ambient temperature of cables is investigated in the last part and changes in the signal quality are clarified.

Contents

List of Figures	IX
List of Tables	XV
List of Equations	XVI
List of Abbreviations	XVII
1 Introduction	1
1.1 The Impact of Moore’s Law	1
1.2 Research Question and Motivation	6
1.3 Aims and Objectives of the Research	8
1.4 New Contribution to Knowledge	12
1.5 Delimitation of the Thesis	13
1.6 Structure of the Thesis	14
2 Communication Technologies and Copper Cables	16
2.1 Internet Traffic	16
2.2 Different Communications Technologie	24
2.2.1 Fibre Optic	24
2.2.2 Copper Cables	25
2.2.3 Wireless Networks	26
2.2.4 Synergy of Fibre Optic, Copper Cables and Wireless Networks	29

2.3	The Development of Communication	32
2.4	Twisted Pair Cable	34
2.5	Installed Types of Cabling	36
2.6	Standards of Cabling and State of Scientific Knowledge	39
2.6.1	Ethernet Standards	39
2.6.2	Cable Standards	40
2.6.3	Ethernet Challenges	43
2.7	Effect of Insertion Loss, Return Loss and Crosstalk on Transmission	44
2.7.1	Definition of Insertion Loss	44
2.7.2	Definition of Return Loss	45
2.7.3	Definition of Near End Crosstalk	46
2.7.4	Definition of Far End Crosstalk	48
2.8	Effect of Noise on Transmission	50
2.9	Need for 100 GBit/s	54
3	Cable Analysis	56
3.1	Spectral Measurements of the Cable	56
3.1.1	Measurement Setup for Spectral Measurements	56
3.1.2	Insertion Loss Measurement	58
3.1.3	Return Loss Measurement	60
3.1.4	Near End Crosstalk Measurement	62
3.1.5	Far End Crosstalk Measurement	63
3.2	Reduction of Insertion Loss Suck Out During Cable Production	65
3.3	Relationship Between Lay Length and Insertion Loss	67
3.4	Prediction of the Insertion Loss	70
3.5	Summary of the Cable Analysis	73
4	Modulation and Simulation of Data Transmission	74

4.1	Pulse Amplitude Modulation (PAM) and Raised Cosine (RC) Filter . . .	74
4.2	Pseudorandom Binary Sequence	81
4.3	Simulation of the Original Signal	83
4.4	Simulation of the Signal at the End of the Cable	86
4.5	Comparison of Original and Simulated Signal at the End of the Cable .	90
4.6	Simulation of Pre-Emphasised Signal	93
4.7	Simulation of Pre-Emphasised Signal at the End of the Cable	96
4.8	Comparison of Original and Simulated Signal with Pre-Emphasis . . .	100
4.9	Summary of Modulation and Simulation of Data Transmission	103
5	High Bit Data Transmission and Bit Error Rate Probability	104
5.1	Bit Error Rate	104
5.2	Measurement Setup of High Bit Data Transmission	107
5.3	Bit Error Rate Probability	110
5.4	Experimental Summary of High Bit Data Transmission	118
6	Transmission Performance in Relation to Higher Temperatures	120
6.1	Background and Present State of Scientific Knowledge	120
6.2	Experiment Setup and Measurements	123
6.3	Insertion Loss in Relation to Higher Temperatures	125
6.4	Return Loss in Relation to Higher Temperatures	128
6.5	Near End Crosstalk in Relation to Higher Temperatures	131
6.6	Far End Crosstalk in Relation to Higher Temperatures	133
6.7	Experiment Setup and Measurements	135
6.8	Experimental Summary of Higher Temperature	139
7	Conclusion and Future Work	141
7.1	Conclusion	141
7.2	Suggestion for Future Work	145

7.2.1	Modulation	145
7.2.2	Practical Implementation of the Results	146
7.2.3	Bit Error Rate	146
7.2.4	Standards	147
8	Appendix	148
8.1	Publication	148
8.2	Pictures of Measurements Setups	149
8.2.1	Picture of Measurement Setup for Spectral Measurements	149
8.2.2	Picture of Measurement Setup for Data Transmission and Eye Pattern	150
8.2.3	Picture of Measurement Setup with Heating Cabinet	151
8.2.4	Picture of Measurement Setup with Heating Cabinet for Eye Pattern .	152
8.3	Picture and Design Drawing of Test Fixture	153
8.3.1	Design Drawing of Test Fixture	153
8.3.2	Design Drawing of Plastic Holder	154
8.3.3	Picture of Test Fixture	155
8.4	Quantity of Combinations of the Transmitted Signal	156
8.5	Transmission over 10 m	167
8.5.1	Transmission of 10 GBit/s over 10 m	167
8.5.2	Transmission of 20 GBit/s over 10 m	168
8.5.3	Transmission of 30 GBit/s over 10 m	170
8.5.4	Transmission of 40 GBit/s over 10 m	171
8.5.5	Transmission of 50 GBit/s over 10 m	173
8.5.6	Transmission of 60 GBit/s over 10 m	174
8.5.7	Transmission of 70 GBit/s over 10 m	176
8.5.8	Transmission of 80 GBit/s over 10 m	177
8.5.9	Transmission of 90 GBit/s over 10 m	179
8.5.10	Transmission of 100 GBit/s over 10 m	180

8.6	Transmission over 30 m	182
8.6.1	Transmission of 10 GBit/s over 30 m	182
8.6.2	Transmission of 20 GBit/s over 30 m	183
8.6.3	Transmission of 30 GBit/s over 30 m	185
8.6.4	Transmission of 40 GBit/s over 30 m	186
8.6.5	Transmission of 50 GBit/s over 30 m	188
8.6.6	Transmission of 60 GBit/s over 30 m	189
8.6.7	Transmission of 70 GBit/s over 30 m	191
8.6.8	Transmission of 80 GBit/s over 30 m	192
8.6.9	Transmission of 90 GBit/s over 30 m	194
8.6.10	Transmission of 100 GBit/s over 30 m	195
8.7	Transmission over 50 m	197
8.7.1	Transmission of 10 GBit/s over 50 m	197
8.7.2	Transmission of 20 GBit/s over 50 m	198
8.7.3	Transmission of 30 GBit/s over 50 m	199
8.7.4	Transmission of 40 GBit/s over 50 m	200
8.7.5	Transmission of 50 GBit/s over 50 m	201
8.7.6	Transmission of 60 GBit/s over 50 m	202
8.8	Transmission over 75 m	203
8.8.1	Transmission of 10 GBit/s over 75 m	203
8.8.2	Transmission of 20 GBit/s over 75 m	204
8.9	Transmission over 100 m	205
8.9.1	Transmission of 10 GBit/s over 100 m	205
8.9.2	Transmission of 20 GBit/s over 100 m	206
References		207

List of Figures

1	Microprocessor transistor counts 1971 – 2016 [9]	2
2	Global internet traffic [10, p. 7, 11, pp. 4-5]	3
3	Ethernet Standards 1990-2016 [12, 13, 14, 15]	4
4	Global IP traffic in 2016 and forecast of 2021 [21]	9
5	Global IP traffic [31, pp. 5-6]	19
6	Global internet traffic by type [11, p. 31]	21
7	Global internet traffic by geography [11, p. 31]	22
8	Annual infrastructure costs per user [43, pp. 9-10]	27
9	Construction of typical FTP cables [67, p. 3]	34
10	Construction of typical UTP cables [67, p. 3]	35
11	Installed structured cabling 2014 for enterprises and data centres [72]	36
12	Installed structured cabling 2014 USA [72]	37
13	Schematic illustration of IL	45
14	Schematic illustration of RL	46
15	Schematic illustration of NEXT	48
16	Schematic illustration of FEXT	49
17	Schematic illustration of TCL	52
18	Schematic illustration of LCL	53
19	Schematic illustration of TCTL	53
20	Schematic illustration of LCTL	53
21	Measurement setup for spectral measurements	58

List of Figures

22	Measurement of IL and cable category 8.2 up to 3 GHz	59
23	Measurement of RL and cable category 8.2 up to 3 GHz	61
24	Measurement of NEXT and cable category 8.2 up to 3 GHz	62
25	Measurement of FEXT and cable category 8.2 up to 3 GHz	63
26	Schematic Twisted Pair length	67
27	Schematic main stranding length	69
28	Simulated and measured IL and cable category 8.2 up to 3 GHz . . .	71
29	100 symbols of PAM 16 (40 GBit/s), rectangular pulse	75
30	Spectrum of PAM 16 (40 GBit/s), rectangular pulse	77
31	100 symbols of PAM 16 (40 GBit/s), RC	79
32	Spectrum of PAM 16 (40 GBit/s), RC	80
33	Combination of two consecutive symbols	81
34	Eye Pattern of PAM 16 (40 GBit/s), RC	84
35	100 symbols of PAM 16 (40 GBit/s), with impact of IL (10 m)	86
36	Spectrum of PAM 16 (40 GBit/s), with impact of IL (10 m)	87
37	Eye Pattern of PAM 16 (40 GBit/s), with impact of IL (10 m)	88
38	100 symbols of PAM 16 (40 GBit/s) and PAM 16 with impact of IL (10 m)	90
39	Spectrum of PAM 16 (40 GBit/s), with impact of IL (10 m)	91
40	Pre-emphasised 100 symbol of, PAM 16 (40 GBit/s) (10 m)	94
41	Spectrum of pre-emphasised PAM 16 (40 GBit/s) (10 m)	95
42	Pre-emphasised 100 symbols of PAM 16 (40 GBit/s) (10 m, end) . . .	97
43	Spectrum of pre-emphasised PAM 16 (40 GBit/s) (10 m, end)	98
44	Eye Pattern of pre-emphasised PAM 16 (40 GBit/s), (10 m, end) . . .	99
45	100 symbols of PAM 16 (40 GBit/s) and pre-emphasised PAM 16 (10 m, end)	100
46	Spectrum of PAM 16 (40 GBit/s) and pre-emphasised spectrum (10 m, end)	101

List of Figures

47	Bit Error Rate [97]	106
48	Measurement setup for data transmission and Eye Pattern diagrams	108
49	Eye Pattern PAM 16 (40 GBit/s), 10 m, abscissa: 40 ps/div - ordinate: 120 mV	111
50	Eye Pattern of the eyes [1-3] of PAM 16 (40 GBit/s), 10 m	112
51	Eye Pattern of the eyes [4-6] of PAM 16 (40 GBit/s), 10 m	112
52	Eye Pattern of the eyes [7-9] of PAM 16 (40 GBit/s), 10 m	113
53	Eye Pattern of the eyes [10-12] of PAM 16 (40 GBit/s), 10 m	113
54	Eye Pattern of the eyes [13-15] of PAM 16 (40 GBit/s), 10 m	114
55	Measurement setup with heating cabinet	124
56	IL as a function of temperature, cable Cat 8.2 and guideline value for 100 °C	125
57	Ratio between IL at 20 °C up to 100 °C	127
58	RL as a function of temperature and cable Cat 8.2	128
59	RL of lower frequencies as a function of temperature and cable Cat 8.2	129
60	RL of higher frequencies as a function of temperature and cable Cat 8.2	130
61	NEXT as a function of temperature and cable Cat 8.2	132
62	ACRF as a function of temperature and cable Cat 8.2	133
63	Measurement setup with heating cabinet for Eye Pattern	135
64	Eye Pattern of PAM 5 with a data rate of 1 GBit/s at a temperature of 20 °C	136
65	Eye Pattern of PAM 5 with a data rate of 1 GBit/s at a temperature of 100 °C	137
66	Picture of measurement setup for spectral measurements	149
67	Picture of measurement setup for data transmission and Eye Pattern	150
68	Picture of measurement setup with heating cabinet	151
69	Picture of measurement setup with heating cabinet	152

List of Figures

70	Design drawing of test fixture	153
71	Design drawing of plastic holder	154
72	Picture of test fixture	155
73	10 m - PAM 8 - 0.84 GBd - abscissa: 119 ps/div - ordinate: 170 mV .	167
74	10 m - PAM 16 - 0.63 GBd - abscissa: 159 ps/div - ordinate: 180 mV .	167
75	10 m - PAM 32 - 0.50 GBd - abscissa: 200 ps/div - ordinate: 190 mV .	168
76	10 m - PAM 8 - 1.67 GBd - abscissa: 60 ps/div - ordinate: 140 mV . .	168
77	10 m - PAM 16 - 1.25 GBd - abscissa: 80 ps/div - ordinate: 160 mV .	169
78	10 m - PAM 32 - 1.00 GBd - abscissa: 100 ps/div - ordinate: 160 mV .	169
79	10 m - PAM 8 - 2.50 GBd - abscissa: 40 ps/div - ordinate: 120 mV . .	170
80	10 m - PAM 16 - 1.88 GBd - abscissa: 53 ps/div - ordinate: 130 mV .	170
81	10 m - PAM 32 - 1.50 GBd - abscissa: 67 ps/div - ordinate: 140 mV .	171
82	10 m - PAM 8 - 3.34 GBd - abscissa: 30 ps/div - ordinate: 100 mV . .	171
83	10 m - PAM 16 - 2.50 GBd - abscissa: 40 ps/div - ordinate: 120 mV .	172
84	10 m - PAM 32 - 2.00 GBd - abscissa: 50 ps/div - ordinate: 130 mV .	172
85	10 m - PAM 8 - 4.17 GBd - abscissa: 24 ps/div - ordinate: 88 mV . . .	173
86	10 m - PAM 16 - 3.13 GBd - abscissa: 32 ps/div - ordinate: 110 mV .	173
87	10 m - PAM 32 - 2.50 GBd - abscissa: 40 ps/div - ordinate: 120 mV .	174
88	10 m - PAM 8 - 5.00 GBd - abscissa: 20 ps/div - ordinate: 72 mV . . .	174
89	10 m - PAM 16 - 3.75 GBd - abscissa: 27 ps/div - ordinate: 94 mV . .	175
90	10 m - PAM 32 - 3.00 GBd - abscissa: 33 ps/div - ordinate: 110 mV .	175
91	10 m - PAM 8 - 5.84 GBd - abscissa: 17 ps/div - ordinate: 62 mV . . .	176
92	10 m - PAM 16 - 4.38 GBd - abscissa: 23 ps/div - ordinate: 84 mV . .	176
93	10 m - PAM 32 - 3.50 GBd - abscissa: 29 ps/div - ordinate: 94 mV . .	177
94	10 m - PAM 8 - 6.67 GBd - abscissa: 15 ps/div - ordinate: 52 mV . . .	177
95	10 m - PAM 16 - 5.00 GBd - abscissa: 20 ps/div - ordinate: 72 mV . .	178
96	10 m - PAM 32 - 4.00 GBd - abscissa: 25 ps/div - ordinate: 88 mV . .	178

List of Figures

97	10 m - PAM 8 - 7.50 GBd - abscissa: 13 ps/div - ordinate: 46 mV . . .	179
98	10 m - PAM 16 - 5.63 GBd - abscissa: 18 ps/div - ordinate: 64 mV . .	179
99	10 m - PAM 32 - 4.50 GBd - abscissa: 22 ps/div - ordinate: 80 mV . .	180
100	10 m - PAM 8 - 8.34 GBd - abscissa: 12 ps/div - ordinate: 46 mV . . .	180
101	10 m - PAM 16 - 6.25 GBd - abscissa: 16 ps/div - ordinate: 58 mV . .	181
102	10 m - PAM 32 - 5.00 GBd - abscissa: 20 ps/div - ordinate: 72 mV . .	181
103	30 m - PAM 8 - 0.84 GBd - abscissa: 119 ps/div - ordinate: 170 mV .	182
104	30 m - PAM 16 - 0.63 GBd - abscissa: 159 ps/div - ordinate: 180 mV .	182
105	30 m - PAM 32 - 0.50 GBd - abscissa: 200 ps/div - ordinate: 190 mV .	183
106	30 m - PAM 8 - 1.67 GBd - abscissa: 60 ps/div - ordinate: 140 mV . .	183
107	30 m - PAM 16 - 1.25 GBd - abscissa: 80 ps/div - ordinate: 160 mV .	184
108	30 m - PAM 32 - 1.00 GBd - abscissa: 100 ps/div - ordinate: 160 mV .	184
109	30 m - PAM 8 - 2.50 GBd - abscissa: 40 ps/div - ordinate: 120 mV . .	185
110	30 m - PAM 16 - 1.88 GBd - abscissa: 53 ps/div - ordinate: 130 mV .	185
111	30 m - PAM 32 - 1.50 GBd - abscissa: 67 ps/div - ordinate: 140 mV .	186
112	30 m - PAM 8 - 3.34 GBd - abscissa: 30 ps/div - ordinate: 100 mV . .	186
113	30 m - PAM 16 - 2.50 GBd - abscissa: 40 ps/div - ordinate: 120 mV .	187
114	30 m - PAM 32 - 2.00 GBd - abscissa: 50 ps/div - ordinate: 130 mV .	187
115	30 m - PAM 8 - 4.17 GBd - abscissa: 24 ps/div - ordinate: 88 mV . . .	188
116	30 m - PAM 16 - 3.13 GBd - abscissa: 32 ps/div - ordinate: 110 mV .	188
117	30 m - PAM 32 - 2.50 GBd - abscissa: 40 ps/div - ordinate: 120 mV .	189
118	30 m - PAM 8 - 5.00 GBd - abscissa: 20 ps/div - ordinate: 72 mV . . .	189
119	30 m - PAM 16 - 3.75 GBd - abscissa: 27 ps/div - ordinate: 94 mV . .	190
120	30 m - PAM 32 - 3.00 GBd - abscissa: 33 ps/div - ordinate: 110 mV .	190
121	30 m - PAM 8 - 5.84 GBd - abscissa: 17 ps/div - ordinate: 62 mV . . .	191
122	30 m - PAM 16 - 4.38 GBd - abscissa: 23 ps/div - ordinate: 84 mV . .	191
123	30 m - PAM 32 - 3.50 GBd - abscissa: 29 ps/div - ordinate: 94 mV . .	192

List of Figures

124	30 m - PAM 8 - 6.67 GBd - abscissa: 15 ps/div - ordinate: 52 mV . . .	192
125	30 m - PAM 16 - 5.00 GBd - abscissa: 20 ps/div - ordinate: 72 mV . .	193
126	30 m - PAM 32 - 4.00 GBd - abscissa: 25 ps/div - ordinate: 88 mV . .	193
127	30 m - PAM 8 - 7.50 GBd - abscissa: 13 ps/div - ordinate: 46 mV . . .	194
128	30 m - PAM 16 - 5.63 GBd - abscissa: 18 ps/div - ordinate: 64 mV . .	194
129	30 m - PAM 32 - 4.50 GBd - abscissa: 22 ps/div - ordinate: 80 mV . .	195
130	30 m - PAM 8 - 8.34 GBd - abscissa: 12 ps/div - ordinate: 46 mV . . .	195
131	30 m - PAM 16 - 6.25 GBd - abscissa: 16 ps/div - ordinate: 58 mV . .	196
132	50 m - PAM 8 - 0.84 GBd - abscissa: 119 ps/div - ordinate: 170 mV .	197
133	50 m - PAM 16 - 0.63 GBd - abscissa: 159 ps/div - ordinate: 180 mV .	197
134	50 m - PAM 32 - 0.50 GBd - abscissa: 200 ps/div - ordinate: 190 mV .	198
135	50 m - PAM 8 - 1.67 GBd - abscissa: 60 ps/div - ordinate: 140 mV . .	198
136	50 m - PAM 16 - 1.25 GBd - abscissa: 80 ps/div - ordinate: 160 mV .	199
137	50 m - PAM 8 - 2.50 GBd - abscissa: 40 ps/div - ordinate: 120 mV . .	199
138	50 m - PAM 16 - 1.88 GBd - abscissa: 53 ps/div - ordinate: 130 mV .	200
139	50 m - PAM 8 - 3.34 GBd - abscissa: 30 ps/div - ordinate: 100 mV . .	200
140	50 m - PAM 16 - 2.50 GBd - abscissa: 40 ps/div - ordinate: 120 mV .	201
141	50 m - PAM 8 - 4.17 GBd - abscissa: 24 ps/div - ordinate: 88 mV . . .	201
142	50 m - PAM 16 - 3.13 GBd - abscissa: 32 ps/div - ordinate: 110 mV .	202
143	50 m - PAM 8 - 5.00 GBd - abscissa: 20 ps/div - ordinate: 72 mV . . .	202
144	75 m - PAM 8 - 0.84 GBd - abscissa: 119 ps/div - ordinate: 170 mV .	203
145	75 m - PAM 16 - 0.63 GBd - abscissa: 159 ps/div - ordinate: 180 mV .	203
146	75 m - PAM 8 - 1.67 GBd - abscissa: 60 ps/div - ordinate: 140 mV . .	204
147	100 m - PAM 8 - 0.84 GBd - abscissa: 119 ps/div - ordinate: 170 mV .	205
148	100 m - PAM 8 - 1.67 GBd - abscissa: 60 ps/div - ordinate: 140 mV .	206

List of Tables

1	Global IP traffic, from 2017 with a forecast up to 2022 [11, p. 31] . . .	18
2	Comparison of fibre optic, copper cables and local wireless networks	30
3	Ethernet line encoding [2, pp. 12-15]	40
4	Category and typical cable design [67, pp. 4-5]	42
5	Class and typical cable design [67, pp. 4-5]	42
6	BER probability of a data transmission of 10 m	115
7	BER probability of a data transmission of 30 m	116
8	BER probability of a data transmission of 50 m	116
9	BER probability of a data transmission of 75 m	116
10	BER probability of a data transmission of 100 m	117
11	Quantity of combinations of the transmitted signal	156

List of Equations

1	Equation 01	44
2	Equation 02	46
3	Equation 03	47
4	Equation 04	48
5	Equation 05	66
6	Equation 06	67
7	Equation 07	68
8	Equation 08	68
9	Equation 09	69
10	Equation 10	70
11	Equation 11	76
12	Equation 12	78
13	Equation 13	105

List of Abbreviations

4G	F ourth Generation of Broadband Cellular Network Technology
5G	F ifth Generation of Broadband Cellular Network Technology
ACRF	Attenuation to C rosstalk R atio at the F ar End
AWG	A rbitrary W aveform G enerator
BER	B it E rror R ate
Cat	C ategory
CATV	C able T ele V ision
CENELEC	C omité E uropéen de N ormalisation É lectrotechnique English: European Committee for Electrotechnical Standardization
CM	C ommon M ode
DDR4	D ouble D ata R ate f our
DM	D ifferential M ode
DSQ	D ouble S quare Q uadrature
DUT	D evice u nder T est
ELTCL	E qual L evel T raverse C onversion Transfer L oss
EMC	E lectromagnetic C ompatibility
EMI	E lectromagnetic I nterference
F	F oil Shielding
FEXT	F ar E nd C rosstalk
FTP	F oil shielded T wisted P airs
IEEE	Institute of E lectrical and E lectronics E ngineers

List of Abbreviations

IL	I nsertion L oss
IP	I nternet P rotocol
IP VOD	I nternet P rotocol V ideo o n D emand
LCL	L ongitudinal C onversion L oss
LCTL	L ongitudinal C onversion T ransfer L oss
MLT-3	M ultilevel T ransmission E ncoding with three levels
NEXT	N ear E nd C rosstalk
PAM	P ulse A mplitude M odulation
PiMF	P air in M etal F oil
POE	P ower o ver E thernet
PRBS	P seudorandom B inary S equence
RC	R aised C osine
RFI	R adio F requency I nterference
RL	R eturn L oss
S	B raided S hielding
SF	B raided S hielding and F oil S hielding
SMA	S ubminiature version A
TCL	T ransverse C onversion L oss
TCTL	T ransverse C onversion T ransfer L oss
U	U nshielded
UTP	U nshielded T wisted P air
WiFi	W ireless F idelity
WL	W ire L ength

Acknowledgement

Without the support from different sides this work would not have been possible in the form and the time, for which I would like to thank many people:

First of all, I would like to thank Prof. Alistair Duffy for being my first supervisor of my PhD and for the support in all sections of my PhD. The discussions and suggestions have decisively helped me to concretize this work and to steer it in the right direction.

Many thanks to Dr. Ammar Ghazal for being my second supervisor and for patient and stimulating discussions. The comments and questions about my work have helped me to see my own work from a different perspective.

This work is the result of a cooperation between De Montfort University and Reutlingen University. I owe special thanks to Prof. Albrecht Oehler for the local supervision of my work and the many answered questions which brought me in a lot of conversations hints and ideas. Many thanks to my two colleagues, Rainer Friedrich and Halil Sari, for their constant support with graphic and technical questions.

The research project at Reutlingen University was funded by the Federal Republic of Germany and is a cooperative project involving two companies. The first company is a manufacturer of cables and cable systems, LEONI Kerpen GmbH. The second company is HARTING Electronics GmbH, a manufacturer of connector technology.

Many thanks to Yvan Engels (LEONI Kerpen GmbH) and Rainer Schmidt (HARTING Electronics GmbH). You welcomed me lovingly into your team and often took the time to discuss my questions with me. Furthermore, I would like to thank the Federal Government of Germany as a sponsor for the research project.

Last but not least, I would like to thank my family in particular for the support and patience they have shown in making my dream of a doctorate possible.

1 Introduction

This chapter introduces data transmission over copper cable and explains why it is of relevance today. Issues related to the need of copper cable are discussed. The work presented in this thesis is being distinguished from other work. It explains what is the novel contribution of this thesis and what has been done by other parties. Finally an outline of the rest of the thesis is provided.

1.1 The Impact of Moore's Law

A forecast of the required bandwidths and data rates is of particular interest for companies. Future forecasts can be used to align corporate strategy and technology strategies [3, p. 1, 4, pp. 140-141]. Gordon Moore is known for his prediction of rising transistors counts in integrated circuits. This prediction can also be applied to the data rate.

Gordon Moore is co-founder of Intel. In 1968, together with Robert Noyce, he founded today's largest semiconductor manufacturer in the world[5, 6]. As early as the 1960s, Gordon Moore predicted the rapid development of the number of components on integrated circuits through an annual doubling [7, pp. 1-2]. Nowadays it is assumed that the number doubles every 18 months [8, p. 240]. Figure 1 shows the continuous development of Intel transistors from 1971 to 2016 [9].

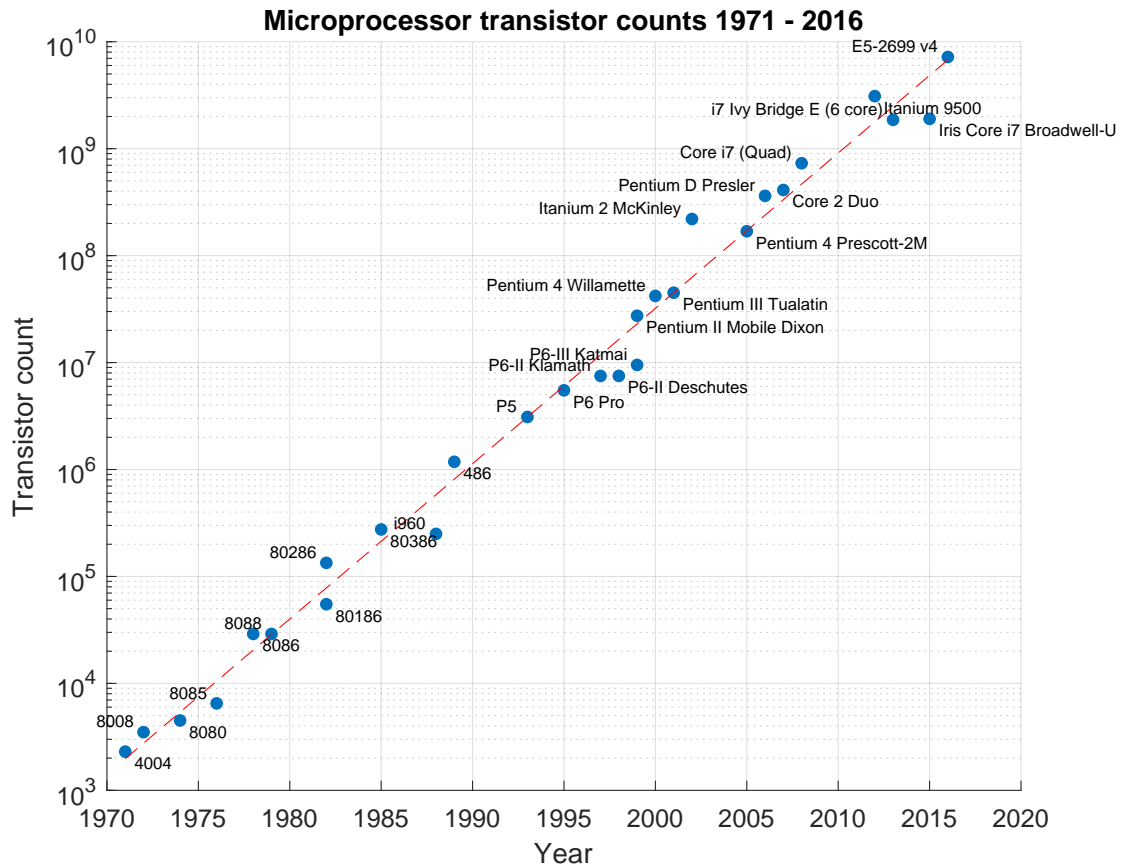

Figure 1 – Microprocessor transistor counts 1971 – 2016 [9]

In connection with this constantly increasing amount of data, the number of data transfers is also growing continuously. The development of the transmitted data of the global internet traffic shows the steady growth. Figure 2 shows global internet traffic per month in gigabytes [10, p. 7, 11, pp. 4-5]. The graph shows the period from 1992 to a forecast in 2022 in 5 year steps.

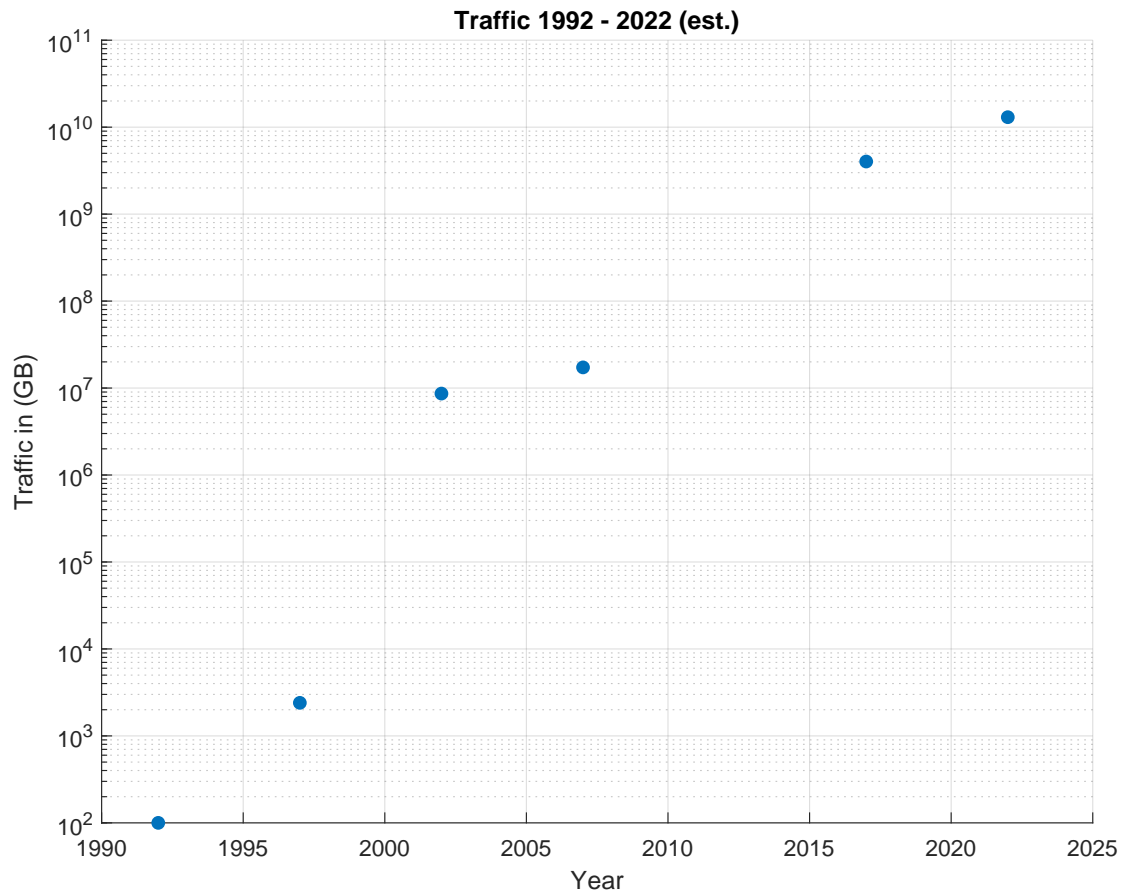

Figure 2 – Global internet traffic [10, p. 7, 11, pp. 4-5]

Although Moore's law was not defined to describe the development of data rates, it applies to the same extent and can also be used for this purpose. Figure 3 illustrates the development of Ethernet standard over the years.

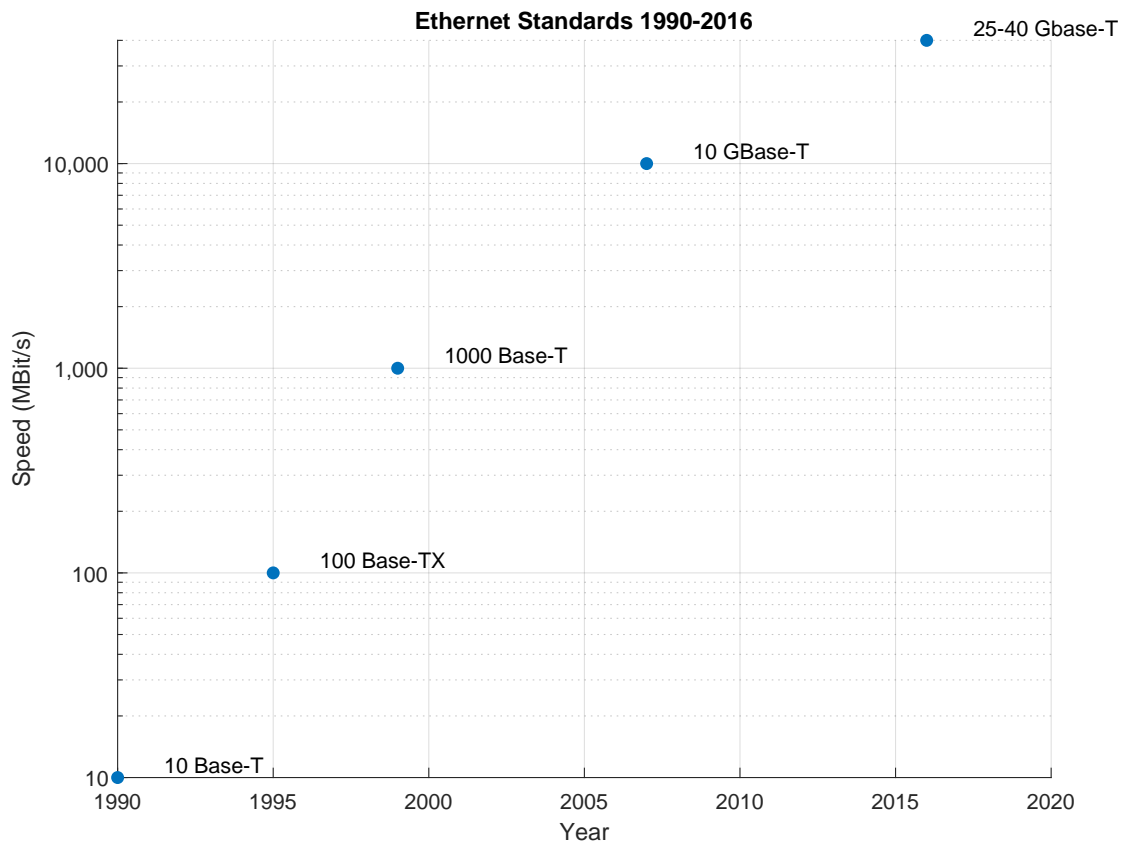

Figure 3 – Ethernet Standards 1990-2016 [12, 13, 14, 15]

The digitalization and this rapid development of data rates are characterizing our future. The increasing importance of the internet, as well as the growing data volumes in data centres and storage networks require new and constantly improving transmission technologies [16, p. 214, 17, pp. 34-37]. It is permanently changing our everyday life.

The future production is also changing. It is characterized by a high degree of individualisation of products and thus a very flexible production. Customers demand individual, high-quality and yet inexpensive products in shorter periods of time. Furthermore, products must be produced as sustainably as possible in view of increasingly scarce resources [18].

In future production, all machines, such as the milling machine and the welding robot, will be networked. Each workpiece will be able to store information via an individual system. This could be, for example, information about the customer, appointments as well as personalized or special configurations of the workpiece. This allow operators to clearly identify and locate the parts. All production machines are networked and can communicate with each other. This allow operators to determine exactly which workpiece passes through which production step at which time. This results in a self-organizing manufacturing process [18].

In order to realize it in the future, special attention is paid to automation and data processing in real time. Great amounts of data are collected by machine-generated data and must be transmitted in real time. These large amounts of data as well as complex data are also called big data. The forecast of the transmission rates in the future is steadily growing. Therefore the data rates and data transmission get more and more important [19, p. 49].

In order to meet the future challenges, copper cabling has to increase data rates it can support and this can generally only be done by expanding the frequency bandwidth and enhancing the signalling capability. Furthermore the advantages of copper cable, in particular the easy handling and the ability to remote power equipment, which is a major advantage of copper cable over optical fibres allowing only one wired connection to something like a wireless access point, must be considered.

1.2 Research Question and Motivation

Historically, Twisted Pair Ethernet bandwidths have followed that of optical cables. However, the challenges for each step in frequency become more significant. Fibre optic cables are currently operating at greater than 100 GBit/s and this is the next frontier for Twisted Pair Ethernet.

In this thesis data speeds of up to 100 GBit/s are investigated by using four-pair symmetrical copper cables. The aim is to explore the potential of Pulse Amplitude Modulation (PAM) of higher order than is currently used, and to show that data rates in the range of 40 GBit/s and higher via copper cable can be both technically and economically feasible. Furthermore, different areas of application are to be investigated.

At the time of writing this thesis data rates up to 10 GBit/s over a transmission distance of 100 m and 40 GBit/s over a transmission distance of 30 m for balanced copper cabling were standardized [2]. The bit rate is limited in particular by Insertion Loss and Return Loss, as well as by Near End Crosstalk and Far End Crosstalk assuming negligible noise.

To increase the existing transmission rate it is necessary to improve the transmission characteristics of the cable or to improve the line encoding. An improvement of the physical cable design is for example conceivable by improving the shielding, to decrease the environmental noise or crosstalk, or by increasing the usable bandwidth. The digital signal processing can increase the transmission rate by higher value of line encodings or improving the equalization and amplification of the received signal [20, pp. 1-3].

The research question is to investigate whether it is possible to extend Pulse Amplitude Modulation for the transmission of up to 100 GBit/s data over existing categories of copper cables. First, a theoretical investigation of the transmission is carried out and then this theoretical investigation is practically realized and compared to practical data transmission. Furthermore, the potential of this to influence the data rate as a function of data cable length is investigated. In cooperation with the cable manufacturer, possibilities for further development and improvement of cable performance are to be considered.

To do this, specific challenges need to be overcome. These include the spectral analysis of the copper cables, the theoretical data transmission via copper cables and the equalization of the typical low pass behaviour of the copper cable. These topics are investigated in this thesis. The results obtained are analysed and quantified.

1.3 Aims and Objectives of the Research

According to recent research the biggest driver for more demand for internet speed is video and the streaming of it [21]. In 2016 the total annual traffic was 96 exabyte. The forecast for 2021 is about 278 exabyte. In 2016, 51 % (49 exabyte) of the total traffic is video streaming. In 2021 it will already be 67 (186 exabyte). This almost corresponds to a quadrupling of the video streaming data in only five years [21]. Figure 4 illustrates the enormous increase in internet traffic and the associated bandwidth consumption. Based on the research it can be taken for granted that the total amount of data will continue to increase at a significant rate.

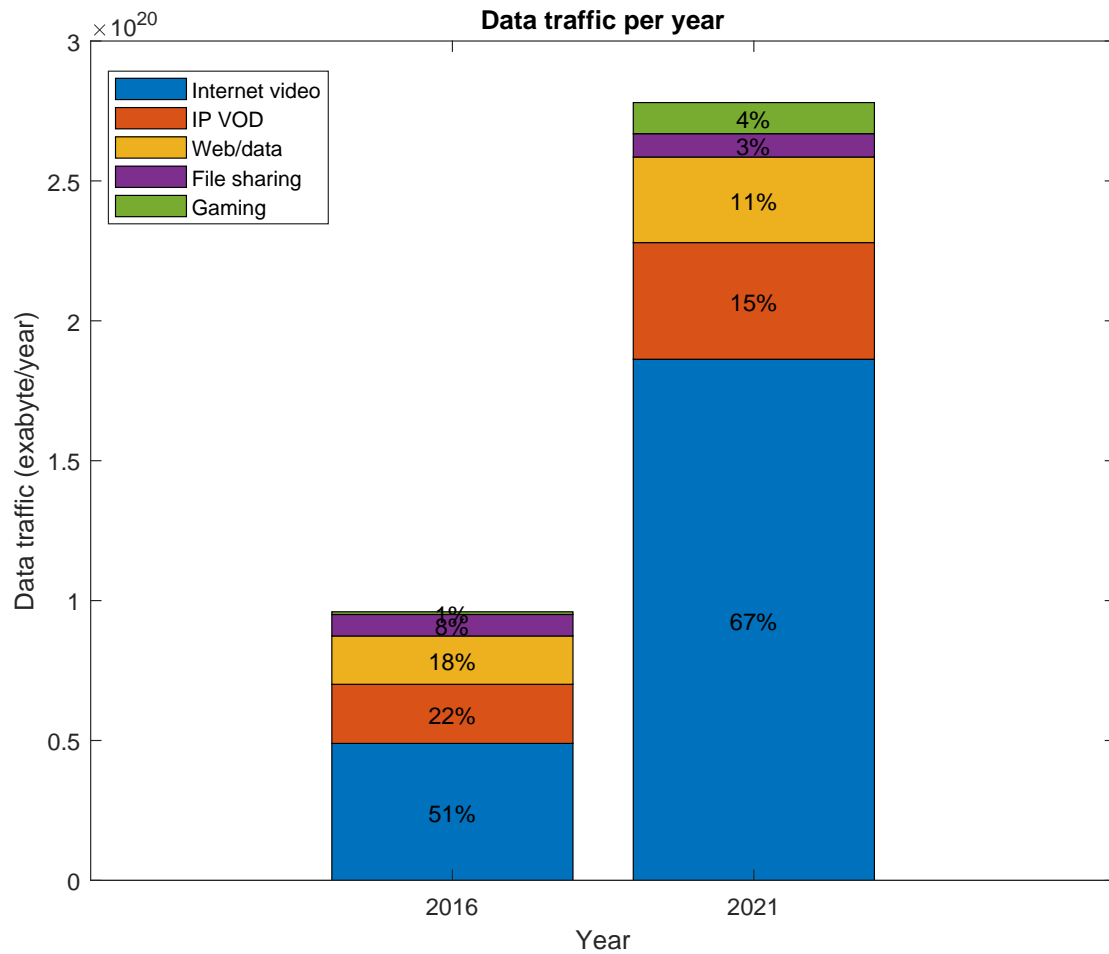

Figure 4 – Global IP traffic in 2016 and forecast of 2021 [21]

Internet users not only watch videos online more often, but the quality of the videos continues to increase. The consumer wants 4k without any delay. Video streaming services are growing strongly and they take over from traditional CATV (cable television) and antenna-TV (television). In addition to traditional TV options, there is also on-demand (IP VOD) content available over the Internet. This enormous increase in online video could triple bandwidth consumption in five years [11, pp. 2-38, 21].

The rapidly increasing internet traffic means that more data has to be transferred in the same time. This demonstrate that there is a projected need for increased data

rates over all types of data transmission media, including copper cabling. Twisted Pair cabling is the preferred medium, as it has advantages over other media, such as lower cost, better flexibility and the high level of current installed base. Hence, this is a strong driver for more than 40 GBit/s over 30 m for, predominantly, data centre applications. In particular, the demand for high-speed data transmissions comes from the data centres [22, pp. 2-5]. Studies have shown that 80 % of the cabling in data centres do not exceed 30 m [23, 23, p. 4]. This offers the opportunity for data cables with higher bandwidths and shorter lengths.

However, current transmission technology is not sufficient to meet future need. This thesis is directed at overcoming the current limitations in transmission technology to achieve the step change required to allow Twisted Pair cable to meet the future market demands in the medium term. During the thesis PAM, as principle modulation scheme, will be investigated due to it being widely used in current Base-T applications and therefore, having a high acceptability to the industry [24, pp. 131-132].

The aim of this investigation is to use existing cables and extending the order of PAM as the modulation scheme, if necessary, in order to achieve a data rate of up to 100 GBit/s over 30 m of cable. If this is not possible, then the limitations of that technology will be identified.

The objectives of the research are:

- to identify the minimum Twisted Pair cable performance requirements for prospective 100 GBit/s transmission and whether this can be achieved with current cabling technology
- to determine the channel equalization and pre-emphasis necessary in order to maximise the data-length product (the maximum amount of data that can be carried over the longest cable)

- to provide guidance on installation related issues to ensure that the research presented in this thesis is of practical use

To achieve the thesis aim and objectives it is necessary to undertake the following steps:

- Analyse the minimum performance requirements of the cable in order to decide on the lowest category of cable that could be used for this application (or if current technology can support this need). This includes the measurement of the Insertion Loss over a frequency range, relate this to the frequency range for PAM and to determine the trade-off required between possible PAM levels and bandwidth needed.
- Analysis of the cable. This part includes all necessary spectral measurements to evaluate the specification for the necessary equalization and pre-emphasis. Furthermore this part of the thesis includes an assessment of practical channel behaviour, compared to theoretical performance in order to achieve PAM 16 or PAM 32 performance.
- Give guidance on installation related issues of practical use, the following investigations will be performed: the transmission characteristics during heating i.e. during the remote powering as the deleterious effect on the channel performance of multiple heating cycles could render the advances of this research moot if not fully accounted for.

1.4 New Contribution to Knowledge

This work is based on previous data transmission standards. Up to now, data rates of up to 10 GBit/s over 100 m and 40 GBit/s over 30 m have been standardized [2]. For the transmission a maximum Pulse Amplitude Modulation of PAM5 or the transmission of DSQ128 is used [25, 26]. Furthermore, the transmission is only standardized up to a temperature of 60 °C[27, 28, 29].

In this thesis innovations in all standards are investigated. The data transmission is extended and examined up to a transmission of 100 GBit/s. In addition to this investigation higher Pulse Amplitude Modulations are used. These not only include 2 bits per symbol but are extended to 3, 4 and 5 bits per symbol and thus to 8, 16 and 32 voltage values. In addition to the expansion of the bits per symbol, new cable lengths are being investigated. Cable lengths of 10, 30, 50, 75 and 100 m are used. The aim of this investigation is to determine the maximum possible data rates for different cable lengths and thus for different applications.

For the determination of the Bit Error Rate of a Pulse Amplitude Modulation of more than PAM 4 a concept is developed and applied. This makes it possible to predict the Bit Error Rate of PAM 8, PAM 16 and PAM 32 and thus to make a statement about the quality of the achieved data transmissions.

Finally, the properties of the cable at temperatures of more than 60 °C are investigated and described. For this purpose, both the spectral properties of the cable are measured and evaluated, and the transmission of a standardized data transmission (PAM 5) at a temperature of 20 °C and a higher temperature of 100 °C is examined.

1.5 Delimitation of the Thesis

Because the focus of this thesis is on the spectral properties and data transmission of existing cables, there is no intensive consideration of the cable structure, neither in terms of material composition nor shielding or twisting.

Prototypes provided by the cable manufacturer are tested during the thesis. These are tested with different lengths. The tests take place in a defined laboratory environment, at the cables, without these being integrated in a network structure.

No connectors are used either. The cables will be connected directly. These are connected to the measuring device using SMA connectors designed and built in-house and are fed with bit sequences.

Only the OSI layer 1 (physical layer) is considered [30, pp. 16-20], which is responsible for the electrical, mechanical and functional control. In this thesis the performance of the cables in connection with the transmission of bits at different cable lengths and the analysis of the bit error analysis is examined.

The impact of the ambient temperature is also considered, further influencing factors which can influence the transmission are not part of the elaboration.

Only Pulse Amplitude Modulation with a Raised Cosine Filter is used as coding, other methods could not be dealt with in this thesis. PAM is being widely used in current Base-T applications and therefore, having a high acceptability to the industry [24, pp. 131-132].

The result of the investigation with the suggestions for improvement to achieve higher cable bandwidths can be incorporated into the further development of the prototype manufacturer.

1.6 Structure of the Thesis

The structure of the thesis is as follows:

Chapter 2 presents the global internet traffic and the current different communications technologies. Furthermore the development of Ethernet and the different Twisted Pair cables will be presented. Afterwards the installed types of cabling are shown as well as the standard of Ethernet cabling. Finally the effect of noise on transmission and the need for 100 GBit/s is presented.

Chapter 3 deals with the spectral properties of the cable (Insertion Loss, Return Loss, Near End Crosstalk and Far End Crosstalk) and the optimization of cabling during the production process. Furthermore, the relationship between lay length and Insertion Loss is discussed, as well as the prediction of Insertion Loss.

Chapter 4 describes the modulation scheme Pulse Amplitude Modulation and the Raised Cosine Filter. Furthermore, an alternative to Pulse Amplitude Modulation, the Orthogonal Frequency Division Multiplexing, is presented. Furthermore the theoretical data transmission with pseudorandom binary sequences is presented. Especially the simulation of the original signal at the output of the AWG and at the end of the cable, as well as a simulation of the pre-emphasised signal are described.

Chapter 5 examines the practical data transmission at different lengths and different bit rates. Furthermore a Bit Error Rate probability is calculated. A matrix with data rates, length and different modulations is presented.

Chapter 6 describes the transmission performance over Twisted Pair cable in relation to temperatures up to 100 °C Especially the spectral characteristics of the cable in relation to higher temperatures is presented.

Chapter 7 concludes the thesis with a summary of the main findings and recommendations for future work.

2 Communication Technologies and Copper Cables

In this chapter, the reasons for the use and popularity of Twisted Pair cables are explained in more detail. To begin with, global internet traffic and different communications technologies are presented. This is followed by the history of Ethernet and different types of Twisted Pair cables. Connected to this, the installed types of Ethernet cables is presented and the different standards of Ethernet cables are examined in more detail. Finally, a short section about the effect of noise on transmission and the future need of 100 GBit/s is presented.

2.1 Internet Traffic

We live in a world that is increasingly characterized by digital devices. Most people are ubiquitous connected, because nearly everybody carries a smartphone all the time. They do not use it only for phoning, but to stay connected with the world. These digital devices should make life easier and support more human tasks and activities. There are more and more sensor-based devices and control devices. With these digital devices, the vision of smart home is possible. A door can be opened or a light switched on by gestures or movements, for example. Contactless keys and cards can also be used to open protected areas without having to remove the key or

card from your pocket. These ubiquitous devices and the associated computer-aided information processing are also known as ubiquitous computing.

One sign of ubiquitous digital devices and the associated increase in data volumes is global internet traffic. The amount of global internet traffic is an indicator for the customer need for bandwidth and data rates and an indicator of the need for the work being undertaken in this thesis. The development and the forecast of global internet traffic, as given in table 1, clearly shows the rate of growth of bandwidth requirements and data rates. It shows the global IP traffic from 2017 up to 2022 [11, p. 31]. The dates are based on Cisco Visual Networking Index: Forecast and trends, 2017 – 2022. It shows the IP traffic by type, by geography and in total. All dates are based on petabytes (10¹⁵ bytes) per month [31, pp. 5-6].

Table 1 – Global IP traffic, from 2017 with a forecast up to 2022 [11, p. 31]

IP traffic, 2017-2022						
Year	2017	2018	2019	2020	2021	2022
By type (Petabytes per month)						
Fixed internet	85	107	137	174	219	273
Managed IP	26	31	35	40	44	45
Mobile data	12	19	29	41	57	77
By geography (Petabytes per month)						
Asia Pacific	43	59	80	105	136	173
North America	42	52	63	77	92	108
Western Europe	18	22	27	33	41	50
Central and Eastern Europe	8	10	12	15	20	25
Latin America	4	5	7	10	15	21
Middle East and Africa	7	9	1	13	16	19
Total (Petabytes per month)						
Total IP traffic	122	156	201	254	319	396

In 2017, the total global IP traffic was at 122 petabytes (1015 bytes) per month. Two years later, in 2019, the global IP traffic will be already over 201 petabytes per month. This is an increase of more than 64 % in only two years.

The forecast for 2022 shows that the total global IP traffic will surpass the 396 petabytes per month. This is an increase of more than 97 % in just three years. This forecast, see figure 5, makes clear that there is a great future demand of

bandwidth and therefore for higher frequencies to meet the customer demand of data transmission [31, pp. 5-6].

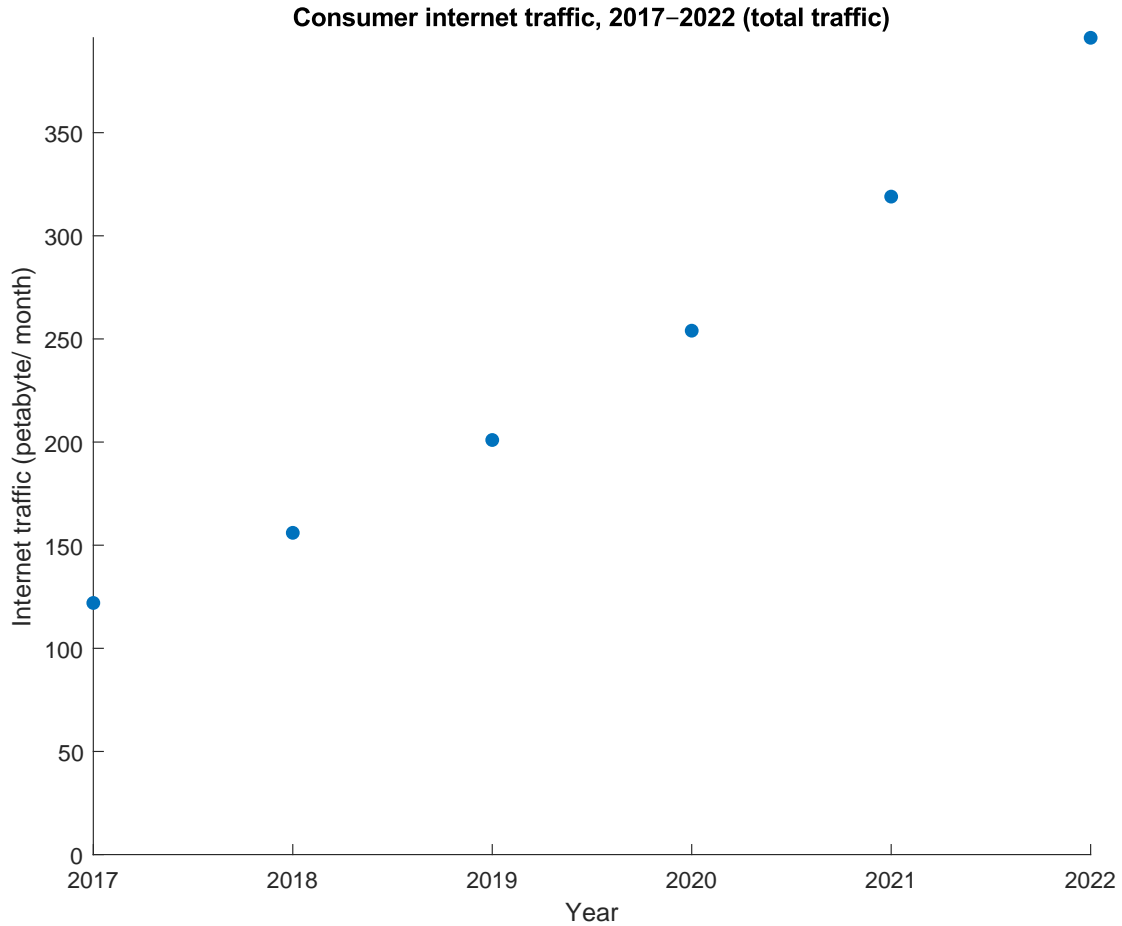

Figure 5 – Global IP traffic [31, pp. 5-6]

Figure 6 illustrates a comparison between fixed internet, managed IP and mobile data since 2017 with a forecast up to 2022. Fixed internet, managed IP and the mobile data strongly increase over the years. In 2017, the mobile data was about 12 petabytes. In the same year, the managed IP was about 26 petabytes and the fixed internet was about 85 petabytes. The forecast for 2022 for the mobile data will be 77 petabytes. For the managed IP it will be 45 petabytes and for the fixed internet it will be 273 petabytes.

Communication Technologies and Copper Cables

Compared with the total IP traffic, this means the mobile data was only 10 % of total IP traffic in 2017. Already in 2022, mobile data will be 19 % of total IP traffic. In 2017 the fixed internet was about 69 % of total IP traffic. The forecast of 2022 of fixed internet in relation to the total IP traffic is also about 68 %. The conclusion is that from 2017 to 2022 the mobile data traffic will grow faster than the fixed IP traffic [11, p. 31]. Even though mobile data will grow faster than fixed internet in the future, it still needs wired elements. One problem with wireless is that the available frequency ranges are limited. In large cities there are so many users and base stations that it is difficult to get a good WiFi running. The individual WiFi can interfere with each other.

WiFi is good for personal use, the so-called last mile. For higher speed requirements, cables will be needed for the foreseeable future. WiFi is used at home or with transport equipment at work. Many routers are connected with cables today. Mobile data is used with devices that are mostly roaming, such as smartphones. Furthermore, it is more difficult to interrupt data traffic on cables, because they require physical access to media or connectivity devices such as switches, because the wireless data traffic can be accessed without a trace.

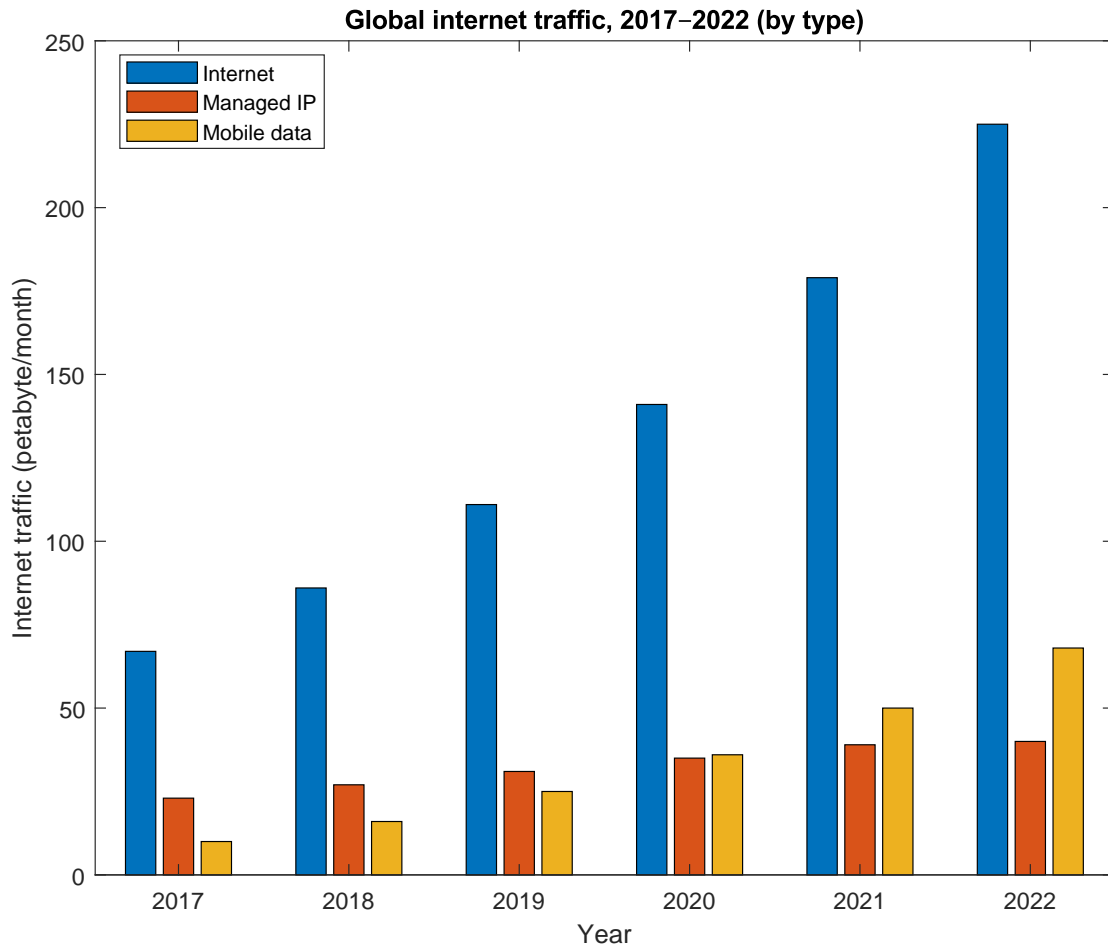

Figure 6 – Global internet traffic by type [11, p. 31]

Figure 7 shows the development of IP traffic by geography. The graphic illustrates that internet traffic is increasing significantly in all regions. Asia Pacific have the fastest growth in absolute terms, followed by North America. In 2017, the internet traffic in Asia Pacific was about 43 petabytes. Five years later, in 2022, the internet traffic in Asia Pacific is about 173 petabytes. This is more than four times higher than 2017.

The development of IP traffic in Europe is divided into Western Europe and Central and Eastern Europe. In Western Europe the IP traffic was about 18 petabytes per

month in 2017. In 2022 it will reach 50 petabytes per month. In Central and Eastern Europe the IP traffic was 8 petabytes in 2017 and will reach 25 petabytes per month in 2022 . The Middle East and Africa have relatively the strongest growth. From 3 petabytes in 2017 it will grow six times to 18 petabytes in 2022. Latin America has the lowest growth from 4 petabytes in 2017 to 14 petabytes in 2022 and has the lowest internet traffic in 2022 [11, p. 31].

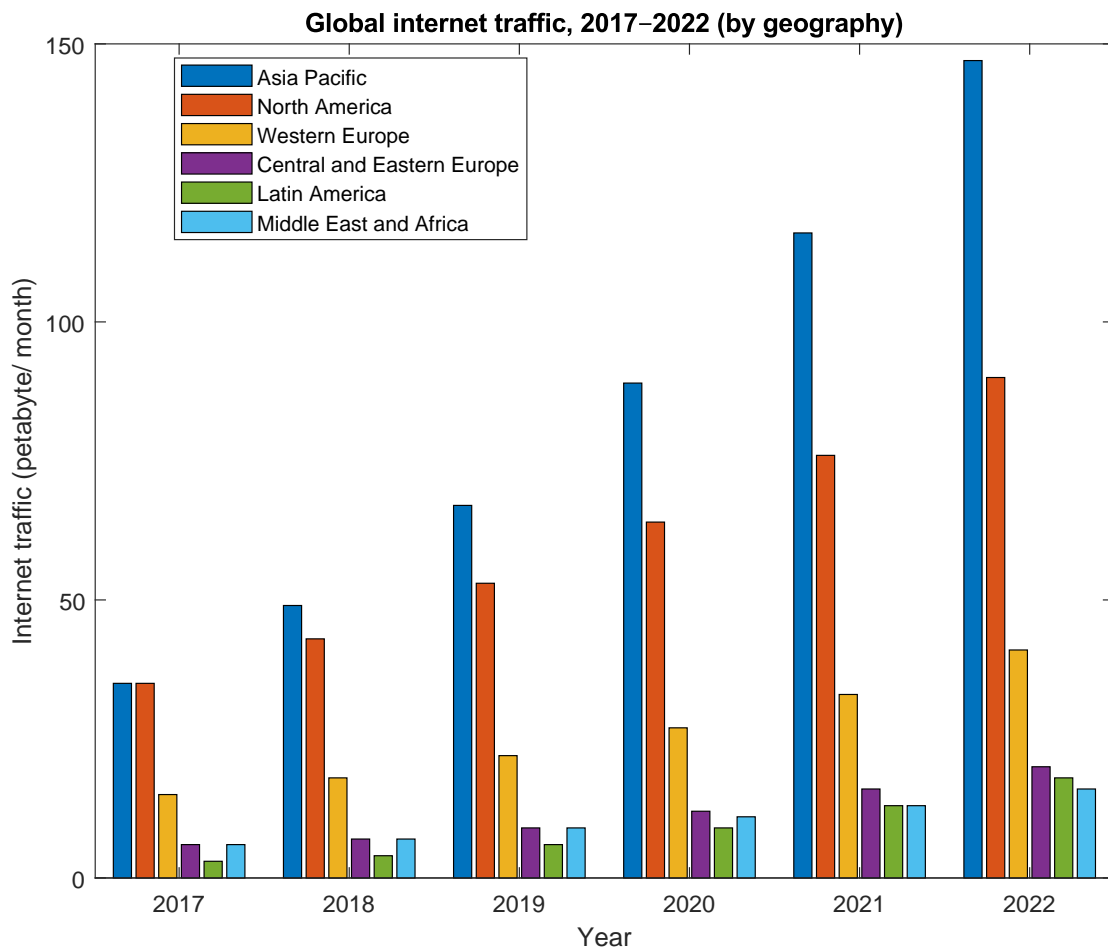

Figure 7 – Global internet traffic by geography [11, p. 31]

The constantly increasing internet traffic and the increasing amount of data associated with it requires more and more data rates. If more data needs to be transferred at the

Communication Technologies and Copper Cables

same time, either the data need longer to transmit (but how many users would be happy to wait longer?) or higher data rates are required to transfer the larger amount of data at the same time. Higher frequency transmissions offer more bandwidth than low frequency transmissions but suffer from increased noise and other factors decreasing the integrity of the signal.

Devices operating at the same frequency interfere with each other by superimposing the signals and result in incorrectly received data. Problems can arise with wireless networks equally because higher frequencies are geographically more isolated and cannot communicate over such long distances than lower frequencies. But with the increase of installed access points this is not the problem it seems at first sight.

2.2 Different Communications Technologie

Data transmission via fibre optics, copper or wireless are all known communication technologies. They have all advantages and disadvantages and different areas of application. To get an overview of the advantages, disadvantages and typical applications of fibre, copper cable and wireless, this section shows the individual communication technologies in more detail. At the end there is an overview of the different transmissions and a summary.

2.2.1 Fibre Optic

First of all fibre optical cables, where the information is transmitted by light, consist of fibres of glass or plastic. The transmission occurs via total internal reflections or guidance.

The main advantages of fibre optical cables are the high range of bandwidth, on the basis of low attenuation [32, p. 347, 33, p. 208]. Fibre optical cables have a high transmission bandwidth and can be used for high data rates. Furthermore fibre optical cables do not use electrical signalling and can be used in potentially explosive atmospheres.

Another advantage is the high noise immunity of fibre optical cables. Fibre optical cables suffer no appreciable crosstalk and are not generally influenced by external electrical, magnetic or electromagnetic fields [34, p. 32].

Moreover fibre optical cables have a high degree of interception protection during data transmission. In comparison with copper cables, fibre optical cables are considerably lighter and require significantly less space than copper cable.

The main disadvantages of fibre optical cables are the high costs for connection technology. Besides that, the installation costs are high because of the higher technical expenditure. Fibre optical cables have a high expenditure of assembly. In addition to the higher costs mentioned so far, the costs for media converter to copper are high. Furthermore, fibre optical cables have expensive and complex measurement technology and expensive equipment technology [35, p. 468, 36, p. 931]. Compared to copper cable, fibre optical cables are relatively sensitive to mechanical stress. Furthermore the installation of fibre optical cables is difficult. Strong curvature can break the fibre in the cable.

2.2.2 Copper Cables

As already mentioned, copper cables transmit data via an electrical current. For this purpose different voltages are generated and transmitted.

The main advantages provided by copper cables are mechanically related advantages. Copper cables are flexible as well as easy to install. They can be plugged and unplugged very often. Furthermore connectors for copper cable can be easily configured. Moreover the prices for copper cable and active components are cheaper than for fibre optical cables [37, pp. 22-23]. Costs for the provision of networks are divided into costs for the components and for the outdoor installation. For fibre optic cables, the cost for the components is 16,118 USD per mile. The cost of the outdoor installation is 26,084 USD per mile. The cost of outdoor copper wiring is 28,682 USD per mile. However, the cost of the components is only 820 USD per mile [38, p. 6]. Another advantage of copper cabling is the possibility of remote powering, e.g. Power over Ethernet (POE). Power over Ethernet technology allows devices to receive power as well as data over one copper cable [39, p. 5]. As a result, in principle no additional power supply cables are required for the various end devices.

The transmission bandwidth of the copper cabling or the length of the copper cabling is limited [37, pp. 18-23]. Therefore active components are required for compensation [40, pp. 93-95]. The main disadvantage of copper cable is associated with electromagnetic disturbances. Due to this, power supply cables and signal cables must be separate from one another. Furthermore fire protection measures are required for the protection of buildings and facilities.

2.2.3 Wireless Networks

Wireless networks are becoming more and more popular. In a wireless network, data is transmitted over radio waves. Every wireless network needs a wireless access point. The 4G technology is the fourth generation of broadband cellular network technology and has a data rate of up to 100 MBit/s [41]. The successor model 5G, the fifth generation of broadband cellular network technology, has a data rate of up to 10 GBit/s [42]. It requires the development of an infrastructure that can reach remote locations. Year after year, the coverage of the mobile network increases, making it a potential alternative to the wired alternative. However, there are still areas with little or no coverage. Without sufficient radio masts, wireless transmission is not a viable choice.

Wireless networks also have the potential to reduce costs. While fibre and copper cables incur costs for cabling and network maintenance, wireless networks can save a large part of these costs. Wireless requires very little maintenance, because no wiring is required and the costs per user are significantly lower than those for traditional infrastructures [43, pp. 9-10]. For example (see figure 8 the annual costs per user for a cable network is about 198 USD (Hardware 110 USD, Software 48 USD, Facilities and bandwidth 33 USD and Power 7 USD). The costs per user for wireless is only

about 131 USD (Hardware 74 USD, Software 24 USD, Facilities and bandwidth 29 USD and Power 4 USD) [43, pp. 9-10].

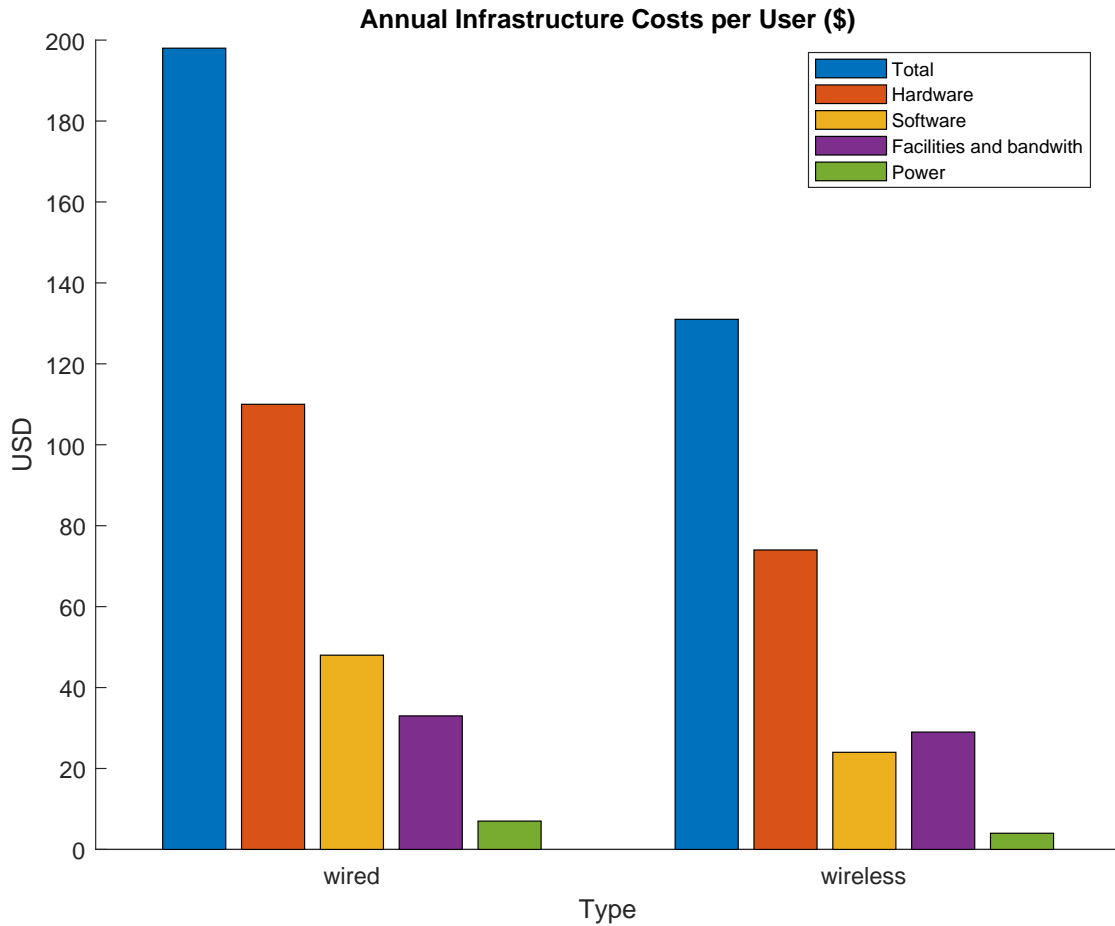

Figure 8 – Annual infrastructure costs per user [43, pp. 9-10]

Another big advantage of wireless networks is mobility and the scalability. It allows access to the server from anywhere. Remote connection is also possible with wireless networks. Expanding a wired network can be costly and difficult when, for example, new cables are added. But expanding a wireless network is easy. A new user is added and the server is updated.

One of the biggest drawbacks is the shared medium of multiple users. The more users use it the lower the data rate. Another disadvantage of wireless networks is that of attenuation: The signal decreases as the distance increases. This means that the further away the user is from the tower, the weaker the signal becomes. Although attenuation is one of the biggest problems with all communication media, an optical fibre can transport a clear signal much further than is possible with wireless networks [44].

Security is an important issue in every transmission. Wireless networks run the risk of modification and eavesdropping. For security reasons, they use certain encryption techniques and authentication mechanisms. However, it has also been found out that some of the encryption techniques can be easily manipulated [45]. The very old encryption scheme WEP is defective and should no longer be used. WPA and WPA2 are also targets of hacker attacks. So far they are not fully hacked, at least not WPA2, but this does not mean that they will not be in the future [46, pp. 34-38].

These points should be particularly considered when using wireless devices, they are more sensitive to hackers as they do not need physical access as if someone wants to intercept a cable.

Such radio frequency communication can be influenced by interference from external sources. Movement with portable devices and the local topology can subject any such communication to slow and fast fading. Slow fading is defined as a channel that remains the same over the entire communication time. Fast fading is defined as a channel that varies greatly over the entire communication time [47, pp. 6-7].

Another problem is, that wireless connections can interfere with one another. And the topology has to be chosen carefully, because it is important that wireless networks are not hindered and that an optimal location is used for the necessary access points

[48]. There are a couple of problems which may arise, like concrete walls, water pipes, elevators or other things or other things in a building which may hinder the function of the wireless LAN.

Furthermore the maximum data throughput of a wireless network is lower than the maximum data throughput of a wired network. In addition, the speed decreases further in busy networks.

2.2.4 Synergy of Fibre Optic, Copper Cables and Wireless Networks

First of all, all three communication technologies can also complement each other. For example, optical fibre is often used for long distances to a distributor. Copper is often used by the distributors for shorter distances. Laptops with copper cables are connected directly to the network when they are in the same house or company. Tablets or mobile phones will primarily use wireless networks. These wireless networks are usually connected with copper cables and Power over Ethernet. So wireless networks often require copper cabling.

The table 2 summarizes the most important points of the various communication technologies.

Communication Technologies and Copper Cables

Table 2 – Comparison of fibre optic, copper cables and local wireless networks

	Fibre optic	Copper cable	Local Wireless
Transmission	Light	Electrical	Radio waves
Distance	High (1-100,000m)	Relatively short (1-100m)	Short (1-50m)
Costs	Higher	Low	Low
Installation	High expenditure of assembly	Easy to install	Easy to install
Advantages	<ul style="list-style-type: none"> • high range of bandwidth • potential-free • high noise immunity • high interception protection 	<ul style="list-style-type: none"> • flexible • easy to install • relatively cheap • remote powering • often existing 	<ul style="list-style-type: none"> • relatively cheap • very little maintenance • mobility and the scalability
Disadvantages	<ul style="list-style-type: none"> • high costs • relatively sensitive to mechanical stress • installation of fibre optical cables is difficult 	<ul style="list-style-type: none"> • electromagnetic disturbances • fire protection measures necessary • length or bandwidth limited 	<ul style="list-style-type: none"> • short distance • bad security • influenced by strong interference • low speed
Application	Long distances	Short distances, mostly in-house or in data centre	Short distances

The benefits and limits of the three communication technologies, fibre optical cabling, copper cabling and wireless networks, clearly show that fibre optical cabling has different applications than copper cabling and wireless networks. Fibre optical cabling is used for long distances, potentially explosive atmospheres and high data rates. Copper cabling and wireless networks are more commonly used for short distances, usually the last few metres.

Copper cabling also plays an important role in data centres and is often used in combination with Power over Ethernet. Even though many advantages speak for fibre optic or wireless networks, copper cables still play an important role in communication technologies today. In particular, the combination of fibre optic up to the building and

Communication Technologies and Copper Cables

copper cable in the building and up to the end device makes use of the respective advantages of the communication technologies. To ensure that the copper cables do not form a bottleneck at the end, it is of immense importance that the bandwidth and the data rate of copper cables are increased. Also for wireless networks that are connected to their wireless access point with copper cables, it is of particular interest that the data rate of copper cables is as high as possible.

2.3 The Development of Communication

The beginning of telecommunications goes a long way back. Around 4,000 BC, letters and numbers were invented [49, p. 3]. This is the basis for the digital communications technology.

For defence reasons, it was very important in the past to transmit information over long distances. A well-known example is the Great Wall of China. Every 5 km a lighthouse was built. The oldest tower dates back to the 11th century BC – 771 BC [50, p. 101]. When an enemy was observed, alarm signals were transmitted with the help of smoke signals. The size of the smoke quantity gave information about the number and size of the enemy [50, p. 101].

At the beginning of the 19th century it started with semaphore in Europe. Not only in Europe, but also in Japan the optical communication with the help of coloured flags was developed [49, p. 3].

Around 1850 electrical telegraphy replaced optical communication [51, pp. 29-33]. Letters and numbers were transmitted with the help of dots and dashes. Samuel Finley Breese Morse is widely regarded as the father of telegraphy [52, p. 24]. Up to this time the communication was digital.

This changed with the development of a telephone by Philip Reis and Alexander Graham Bell in 1876 [53, pp. 549-556], followed by Alexander Graham Bell's invention of Twisted Pair in 1881 [54, p. 72, 55]. From that time telecommunications was dominated by analogue techniques [56, pp. 1-5]. Analogue communication provided new areas of application. The development of an electronic amplifier by John Ambrose Fleming, Lee de Forest and Robert von Lieben between 1904 and

1906 created the foundation for new developments such as sound and television broadcasting [51, pp. 225-228].

In the middle of the 20th century, telecommunications underwent a step change. The invention of the transistor in 1947 by John Bardeen, Walter Houser Brattain and William Shockley [57, pp. 61-63], the invention of the first integrated circuit in 1958 by Jack Kilby [58, p. 362] and the first microprocessor in 1970 are the important foundations for further developments [49, p. 4]. With this progress in microelectronics it is now possible to transfer theoretical approaches into affordable devices. Telecommunications have returned to digitally dominated communication by using analogue carriers. Today digital communication is omnipresent, for example: digital mobile communications, digital radio and digital television, as well as the internet.

The development of Ethernet started around 1973 at the Xerox Palo Alto Research Centre in the United States of America [59, pp. 26-31, 60, pp. 21-22]. Robert Metcalfe is widely regarded as the Father of Ethernet. Since 1983, Ethernet has been through many standardization cycles [61, p. 154]. Ethernet is still developing rapidly. Speeds are increasing all the time (see figure 3). The Twisted Pair cabling used today is also developing rapidly. While data rates of 100 MBit/s were still transmitted in 1995, the speed has increased by a factor of more than 200. In 2016, the Ethernet standard for 40 GBit/s applications was approved. Up to now, this standard has mainly been used in data centres. The past has shown that data centre applications have also established in the workplace [62, pp. 64-68, 63, pp. 1-5].

2.4 Twisted Pair Cable

In this section the structure of Twisted Pair cables in general as well as the differences in shielding will be discussed in more detail. In Twisted Pair cabling two conductors of a single circuit are twisted together as one pair. This method is used in combination with differential signalling where two conductors transmit an equal, but opposite signal. Beside from improved mechanical performance, this is used to cancel out electromagnetic interference from internal as well as external sources [64, pp. 3-9, 65, 66, pp. 3-8]. The cables consist of a sum of Twisted Pairs. The Twisted Pairs are twisted together, too [67, pp. 2-4, 68, pp. 3-8, 69, pp. 58-60].

Twisted Pair cables typically consist of copper and an insulation made of polyethylene. As already mentioned, Twisted Pair cables are divided into two groups. The first type is the Unshielded Twisted Pair cabling (UTP). The second one is Shielded Twisted Pair cabling (S/FTP) or Foil shielded Twisted Pairs (FTP). An overview of the different types of Twisted Pair data cables is demonstrated in the figure 9 for FTP cables and in figure 10 for UTP cables.

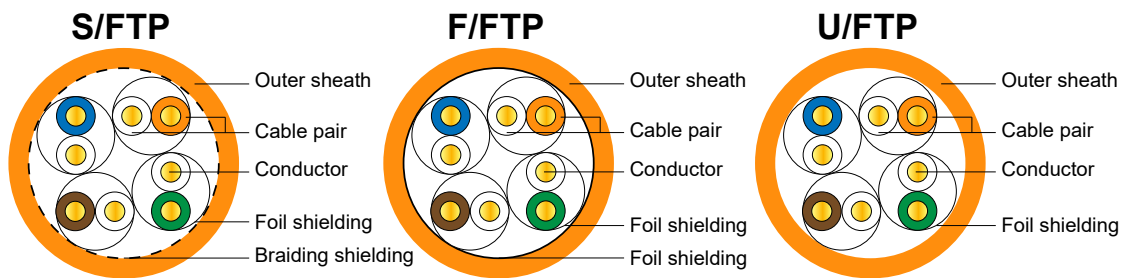

Figure 9 – Construction of typical FTP cables [67, p. 3]

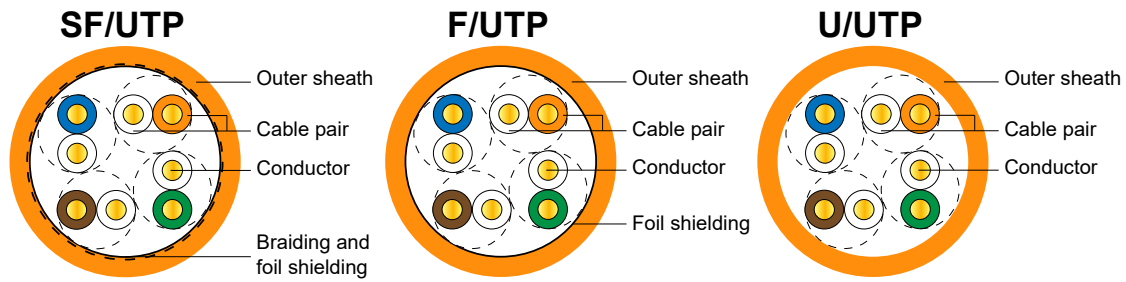

Figure 10 – Construction of typical UTP cables [67, p. 3]

The different types of UTP and FTP differ according to Braided shielding (S), Foil shielding (F), Braided and foil shielding (SF) and Unshielded (U) [70, pp. 88-90, 71, p. 216].

Figure 9 shows foil shielded Twisted Pairs. These foil shielded Twisted Pairs consist of eight conductors. Two of them are twisted into a pair. Each of the pairs is covered with a foil shielding. All four pairs are again surrounded by an outer sheath. The difference between the three foil shielded Twisted Pairs lies in the overall screen. U/FTP stands for unshielded foil shielded Twisted Pair. This means that this cable is shielded in pairs but has no overall shield. With the F/FTP version, the entire screen consists of a further foil shielding. S/FTP or also called PiMF (Pair in Metal Foil), the overall shielding consists of a braided shielding. This version is probably the best shielded copper cable version on the market so far.

The UTP cables are shown in figure 10. These cables also consist of 8 conductors, which are twisted together in pairs. All four pairs are again surrounded by an outer sheath. However, UTP cables are not shielded in pairs. The three variants again differ in the overall shielding. The variant on the right, U/UTP has no shielding. The F/UTP cable has an overall foil shield and the SF/UTP variant has braided and foil shielding.

2.5 Installed Types of Cabling

The total number of cable types installed by 2014 is shown in figure 11. The figure shows an analysis of globally installed structured cabling for enterprises and data centres in 2014 based on cable deliveries. Category (Cat) 6 cables have the highest share at 53 %, closely followed by Cat 5 cables at 38 %. Cables with Cat 6_A have 8 %. Cat 7 cables are in last place with 1 % [72]. The differences between the individual categories are explained in more detail in table 4.

Installed Structured Cabling 2014 for enterprises and data centres

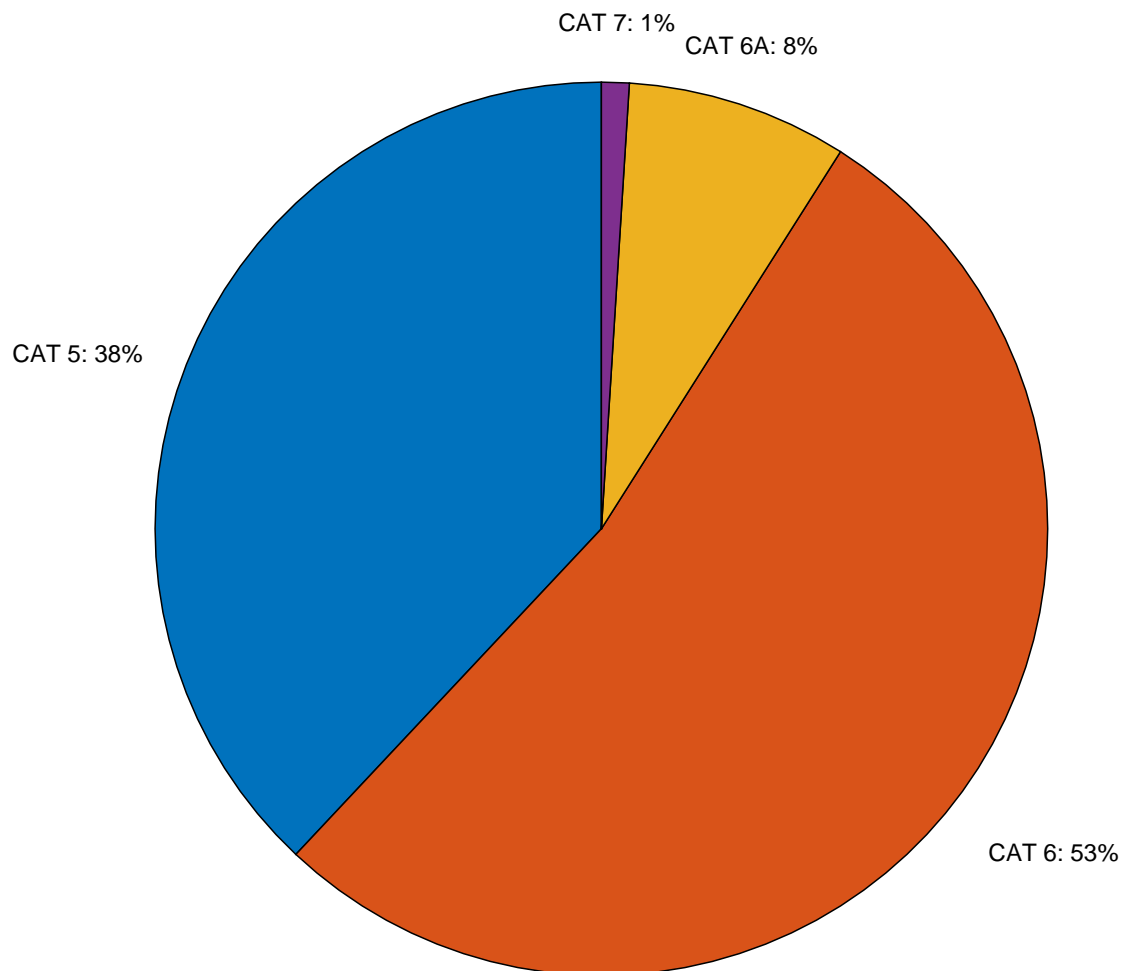

Figure 11 – Installed structured cabling 2014 for enterprises and data centres [72]

Figure 12 shows an analysis for installed outlets in USA enterprises and data centres. In this analysis the highest amount have cables with Cat 5 with 46 %. This is followed by cables of Cat 6 with 28 %. Cables with Cat 6_A have a share of 16 %. Cables of Cat 7 have only 5 % and cables of Cat 7_A have 4 % [72].

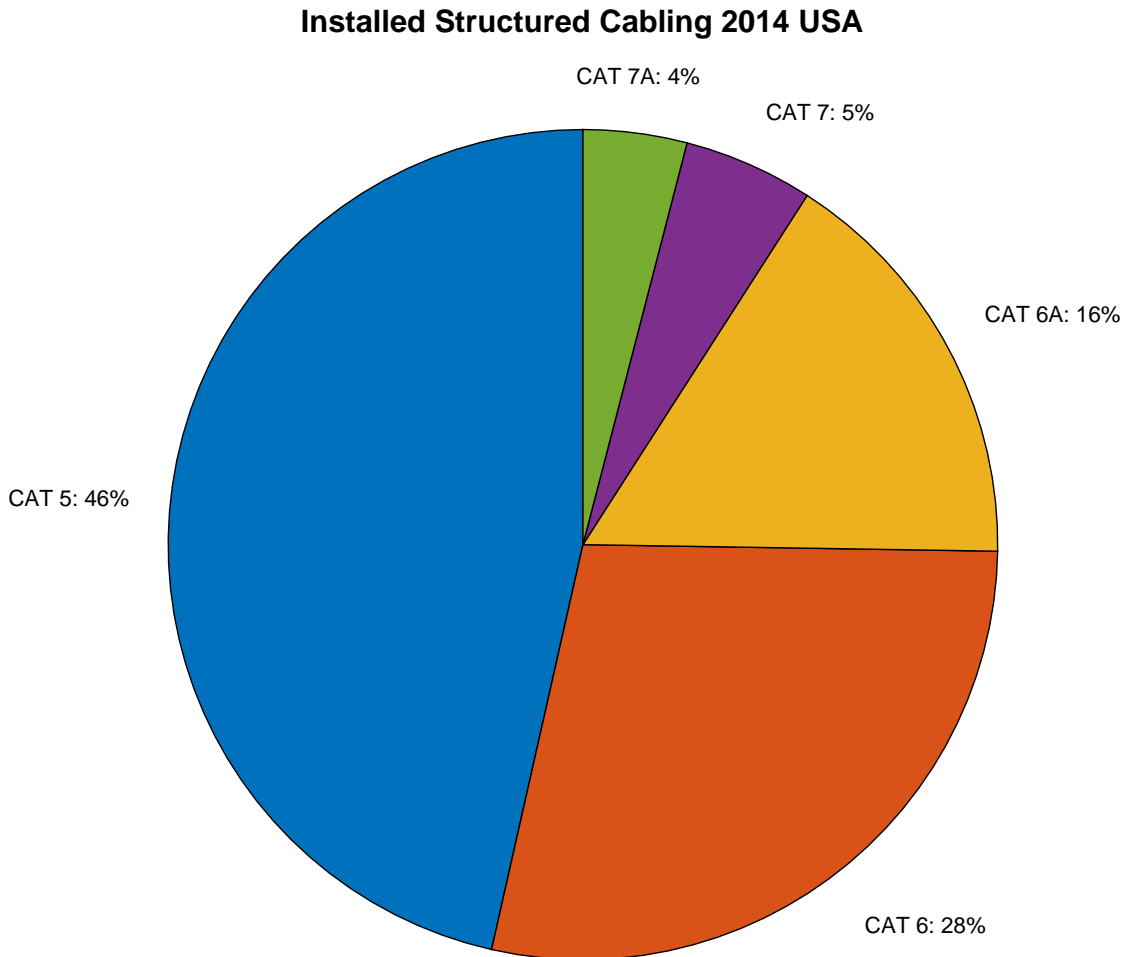

Figure 12 – Installed structured cabling 2014 USA [72]

Both figures, figure 11 and figure 12, show that the cable of categories 5, 6 and 6_A is more often installed than cables of categories 7 and 7_A. The reason therefore could be the higher cost of cables with higher categories in comparison with the costs of cable with lower categories. Another reason could be that cables categories 5, 6 and

Communication Technologies and Copper Cables

6_A have been on the market for some time, while cables with categories 7 and 7_A are still being developed.

2.6 Standards of Cabling and State of Scientific Knowledge

The relevant standards for cabling are divided into two areas. A distinction is made between the standards for the applications and the standards for the cables. These two types of standards are described in more detail below.

2.6.1 Ethernet Standards

The standards for transmission technology according to IEEE 802.3 describe how the data are to be transmitted according to the Ethernet standard. The Institute of Electrical and Electronics Engineers (IEEE) is the world's largest technology association. The aim of this association is to promote technologies and their use. The IEEE has over 900 active standards and over 500 additional standards being developed. For these innovations and standards, members from more than 160 countries come together [73]. Table 3 shows the previous Ethernet standards using copper cables. The Ethernet standards are displayed with the respective year of publication, the bit rate, the line coding and the used length. Table 3 shows the temporal development of the data rates of the Ethernet standard.

As well as the copper cabling, the line encoding has developed with each Ethernet standard. The first Ethernet standard, the 10 Base-T, started with Manchester Coding. This line encoding represented 1 bit per symbol. The bit rate for 10 Base-T is 10 Mbit/s. The 100 Base-T standard uses the Multilevel Transmission Encoding with 3 levels (MLT-3). For MLT-3, a logical 1 changes the signal level. With a logical 0, the signal level is not changed. Like the Manchester Coding, 1 bit per symbol is transmitted.

The next Ethernet standard, the 1000 Base-T standard uses a PAM 5 line encoding. This coding transmits 5 bits per symbol and has a symbol rate of 125 MBd [25]. The 10 GBase-T standard uses the 128-DSQ (Double Square Quadrature) coding with 7 bits per symbol and a symbol rate of 250 MBd [26]. The last Ethernet standard 25/40 GBase-T standard also uses the 128-DSQ coding [2, 74, pp. 135-137]. Table 3 shows the Ethernet line encoding [2, pp. 12-25].

Table 3 – Ethernet line encoding [2, pp. 12-15]

Standard	10 Base-T	100 Base-T	1000 Base-T	10 Gbase-T	25/40 Gbase-T
Bit rate	10 MBit/s	100 MBit/s	1000 MBit/s	10 GBit/s	25/40 MBit/s
Line encoding	Manchester	MLT-3	PAM 5	128-DSQ	128-DSQ
Symbol rate (in MBd)	10	100	125	800	3,200
Cable length (in m)	100	100	100	100	30
Year	1990	1995	1999	2006	2016

2.6.2 Cable Standards

The second standard family for cabling describes the infrastructure associated with the Ethernet standards. The transmission characteristics and the appearance of the cabling are determined on the basis of the transmission requirements of IEEE 802.3. This structured cabling represents a uniform structure plan for different services. For structured cabling there is the international standard ISO/IEC 11801 and the European standard EN 50173-1 of the European Committee for Electrotechnical Standardization (CENELEC) as well as the North American standard TIA/EIA 568C for cabling [62, pp. 64-68].

While TIA/EIA 568C (United States of America) and CENELEC EN 50173 (Europe) only apply locally, the ISO/IEC 11801 standard applies internationally. In the ISO/IEC 11801 standard, 92 nations, including 35 member countries and 57 observing nations, are dealing with structured cabling.

ISO/IEC 10801 specifies the quality characteristics for the cabling, i.e. for the connectors and the cables. A difference is made between the categories for the components and the classes for the transmission paths. Class C to Class II are used for frequencies from 10 MHz to 2 GHz and data transmissions from 10 MBit/s up to 40 GBit/s [75, pp. 57-60].

Data cables are divided into Cat 1 - 8, according to the transmission characteristics. The capacity of data cables are defined by a maximum frequency or maximum bandwidth. Table 4 shows the Cat 3 to 8, the defined frequency and the preferred cable design [67, pp. 4-5, 76, pp. 7-16, 77, pp. 9-15, 27, pp. 8-13, 28, pp. 8-13]. Table 5 shows the Class C to F and I and II, as well as the transmission rate and typical cable design [67, pp. 4-5].

Table 4 – Category and typical cable design [67, pp. 4-5]

Cat		Defined frequency in MHz	Typical cable design					
			U/UTP	F/UTP	SF/UTP	U/FTP	F/FTP	SF/FTP
3	100m	16	Green	Green	Green	Red	Red	Red
4	100m	20	Green	Green	Green	Red	Red	Red
„Old 5”	100m	100	Green	Green	Green	Red	Red	Red
5	100m	100	Green	Green	Green	Red	Red	Red
6	100m	250	Green	Green	Red	Green	Red	Red
6A	100m	500	Green	Green	Red	Green	Green	Red
7	100m	600	Red	Red	Red	Red	Green	Green
7A	100m	1,000	Red	Red	Red	Red	Green	Green
8.1	30m	2,000	Red	Green	Green	Red	Green	Red
8.2	30m	2,000	Red	Red	Red	Red	Red	Green

Table 5 – Class and typical cable design [67, pp. 4-5]

Class	Transmission rate in Mbit/s	Name of application	Typical cable design					
			U/UTP	F/UTP	SF/UTP	U/FTP	F/FTP	SF/FTP
C	10	10 Base-T	Green	Green	Green	Red	Red	Red
old „D”	100	100 Base-T	Green	Green	Green	Red	Red	Red
D	1,000	1000 Base-T	Green	Green	Green	Red	Red	Red
E	1,000	1000 Base-T	Green	Green	Red	Green	Red	Red
EA	10,000	10 GBase-T	Green	Green	Red	Green	Green	Red
F	10,000	10 GBase-T	Red	Red	Red	Red	Green	Green
FA	25,000	25 GBase-T	Red	Red	Red	Red	Red	Green
I (30m)	40,000	40 GBase-T	Red	Green	Green	Red	Green	Red
II (30m)	40,000	40 Gbase-T	Red	Red	Red	Red	Red	Green

2.6.3 Ethernet Challenges

Copper cable is still undergoing development, despite various claims of its impending demise the standards show that copper cables have always evolved and are still used today. But this also means ever higher demands on copper cables. Increasing data rates mean that ever higher frequencies are also required for copper cables in order to satisfy the bandwidth requirements. The characteristics of Twisted Pair copper cables are defined by the fact that the attenuation increases with increasing frequencies. This characteristic of copper cables is also demonstrated, for example, by the length reduction in the new cable categories 7_A, 8.1 and 8.2, where a length of 30 m or 50 m has been standardized instead of the previous 100 m cabling route. The reason for this is that the attenuation of a category 7_A cable with a length of 100 m at a frequency of 2 GHz is already 95 dB. Since this value is far outside the usable range, the Insertion Loss had to be reduced. To get the Insertion Loss into a usable range the cabling length was reduced. Another problem with Twisted Pair copper cables is the Alien Crosstalk. Alien Crosstalk is the term used to describe crosstalk of neighbouring cables. For this reason, the transmission of 40 GBit/s only refers to the use of shielded cabling systems.

2.7 Effect of Insertion Loss, Return Loss and Crosstalk on Transmission

Copper cables are subject to various influences. This chapter describes the spectral influences of copper cables with regard to Insertion Loss, Return Loss, Near End Crosstalk and Far End Crosstalk. The causes of the influences and the measurements of these spectral properties are described in the following.

2.7.1 Definition of Insertion Loss

First of all, the Insertion Loss of copper cables is considered. This effect has the greatest influence on the electrical performance of the copper cable. This effect is measured in the frequency domain. The Insertion Loss of the copper cables depends on the length of the cables and the wire diameter of the cable. The Insertion Loss describes the logarithmic ratio of output and input power. Or in other words the Insertion Loss is the logarithmic ratio of the signal fed into two wires of one Twisted Pair and the signal arriving at the other end of the cable. Due to the skin effect, the Insertion Loss depends on the frequency. Therefore the attenuation of higher frequencies is greater than the attenuation of lower frequencies [78, pp. 55-59].

The Insertion Loss is calculated according to the following formula:

$$D(f) = 20 \cdot \log \left(\frac{U_t(f)}{U_r(f)} \right) [dB] \quad (1)$$

U_t is the input signal voltage and U_r the received signal voltage. The ratio is expressed in dB [78, pp. 55-59].

For Insertion Loss measurement two wires of a Twisted Pair are connected at the near end as well as at the far end. The desired measurement direction and measurement mode can now be selected on the network analyser. The differential mode is of interest for this thesis.

Figure 13 shows the schematic illustration of the Insertion Loss measurement. For Insertion Loss measurement the signal is fed to the near end and measured at the far end.

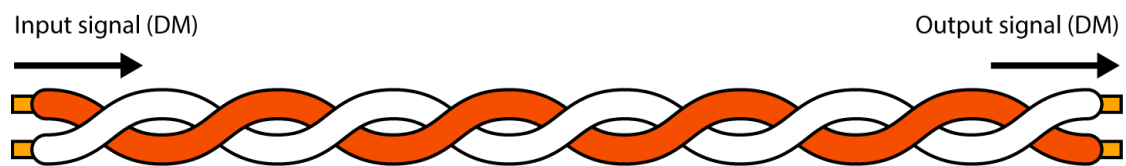

Figure 13 – Schematic illustration of IL

2.7.2 Definition of Return Loss

The causes of Return Loss are inhomogeneities within the cable or within the wiring and mismatch of termination cords and loads giving rise to multiple reflections due to characteristic impedance variations. This may occur during cable production, cable laying, and / or connection points, such as cables to another cable or connector of a device [79, p. 29].

Return loss is a measurement of the cable impedances. Variations of these impedances are undesirable properties of the cable. The Return Loss provides information about the quality of the match. The higher the Return Loss the lower the interference [78, pp. 55-59].

The Return Loss is the ratio of the backscattered power. For the Return Loss measurement the reflective signal is measured as a function of the input signal of the

same pair [79, p. 29]. Return Loss is also measured in the frequency domain. The Return Loss is calculated by using the following formula:

$$R_L(f) = 20 \cdot \log \left(\frac{U_r(f)}{U_i(f)} \right) [dB] \quad (2)$$

U_i corresponds to the input signal voltage at one pair and U_r to the received signal voltage at the same pair. The ratio is given in dB [78, pp. 55-59].

The Return Loss measurement measures the ratio of the input signal at one end of the cable to the output signal at the same end. The schematic illustration of Return Loss is shown in figure 14.

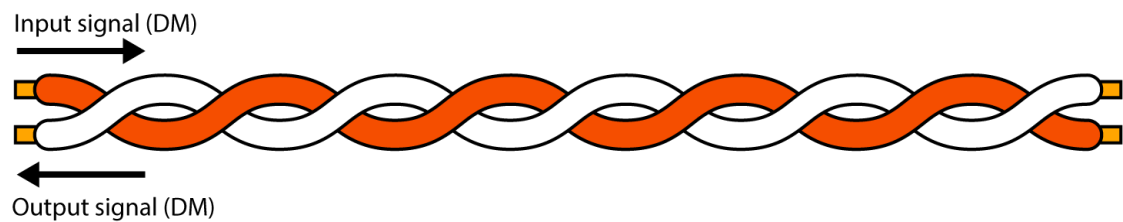

Figure 14 – Schematic illustration of RL

2.7.3 Definition of Near End Crosstalk

The Near End Crosstalk describes coupling between two Twisted Pairs at the beginning of a cable. Near End Crosstalk is the crosstalk of two different pairs of wires at the near end. This is an undesirable effect, since crosstalk causes interference on the other pairs of wires, thus disrupting signal transmission. The measurement of the other Twisted Pair shows how strongly the signal is coupled to the other Twisted Pair. Thus the Near End Crosstalk gives the ratio of the power of the over-coupled signal of a Twisted Pair to the power of the input signal of another Twisted Pair. This effect is

due to electromagnetic fields caused by the signal transmission. If two twisted wires have the same lay lengths, the signal of one pair is always coupled in the same ratio to the second pair. This means that the effect of over-coupled cannot be cancelled out by the difference. Therefore the Near End Crosstalk can be reduced by different lay lengths of the wire pairs of a cable or by paired shielding. Furthermore Near End Crosstalk depends on the cable structure and the quality of the connection to the connection component [78, pp. 55-59].

Near End Crosstalk is calculated by using the following formula:

$$\text{NEXT}(f) = 20 \cdot \log \left(\frac{U_t(f)}{U_r(f)} \right) [dB] \quad (3)$$

U_t corresponds to the input signal voltage at one pair and U_r to the received signal voltage at another pair. Near End Crosstalk is measured in the frequency domain and is also expressed in dB [78, pp. 55-59].

For the Near End Crosstalk measurement two wires of one Twisted Pair are connected at the near end and two wires of another Twisted Pair are also connected at the near end. The network analyser then measures the crosstalk of one Twisted Pair to the other at the near end. Figure 15 shows the schematic illustration of the Near End Crosstalk measurement.

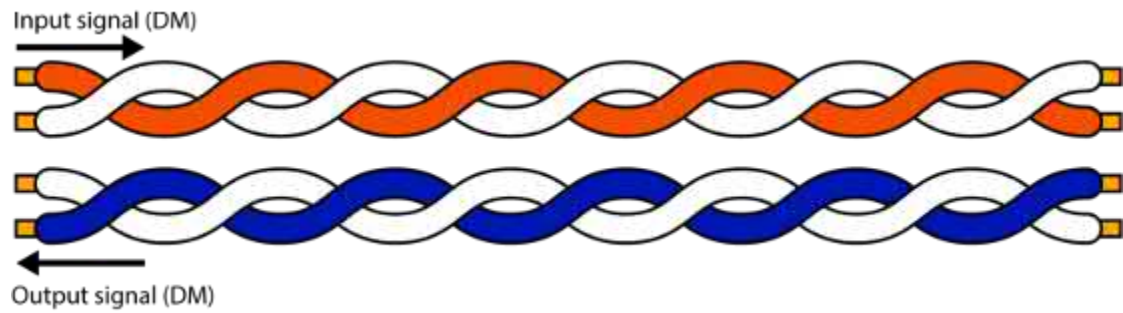

Figure 15 – Schematic illustration of NEXT

2.7.4 Definition of Far End Crosstalk

Not only the crosstalk at the near end of the cable is investigated, but also the crosstalk of wire pairs at the far end of the cable to another wire pair is investigated. This measurement is called Far End Crosstalk. As with Near End Crosstalk, this is an undesirable effect because crosstalk interferes with the desired signal. As with the previous measurements this measurement is also measured in the frequency domain. As with Near End Crosstalk, long-distance crosstalk is dependent on the cables used and on the processing when connecting the cables to the connection components [80, pp. 64-68].

The following formula is used to calculate the Far End Crosstalk:

$$FEXT(f) = 20 \cdot \log \left(\frac{U_t(f)}{U_r(f)} \right) [dB] \quad (4)$$

U_t is the transmitted input signal voltage of the pair at the near end and U_r is the received input signal voltage of the pair at the far end. The measurement is also given in dB [80, pp. 64-68].

In Far End Crosstalk measurement two wires of one Twisted Pair are connected at the near end and two wires of another Twisted Pair are connected at the far end. Similar to the Near End Crosstalk measurement, the network analyser measures the crosstalk of one Twisted Pair to the other at the far end. Figure 16 shows the theoretical measurement mode of the Near End Crosstalk measurement.

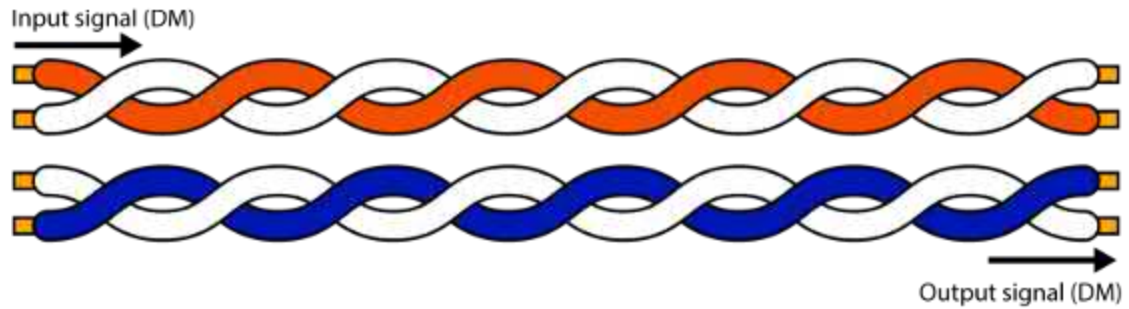

Figure 16 – Schematic illustration of FEXT

2.8 Effect of Noise on Transmission

During data transmission, signals are affected by various factors. They are influenced by the structure and the materials used for the cable as well as by the superposition of noise. Today, copper cable must also work in increasingly noisy environments. For example, the increase in WiFi coverage also increases the common mode currents on the cables [81, pp. 126-131]. Because of this development it is important to know the sources of noise and why they affect the cables. In the following, these points will be discussed in more detail.

Noise affects the entire transmission system. This means that both the transmitter and the receiver are subject to noise in addition to the transmission channel. A difference can be made between external and internal noise sources. Internal noise sources are components that can be assigned to the signal itself. External noise sources are electrical or magnetic phenomena that influence the signal during transmission. Noise can influence the signal in such a way that the correct demodulation of the signal is no longer possible. Whether the noise affects the correct transmission or not depends on the ratio of the total signal power and the total noise level. This ratio is also called the signal-to-noise ratio. If the signal power is very high in relation to the noise level, the noise can often be ignored [82].

Sources of noise can be for example [82]:

- Electromagnetic interference (EMI)
- Radio-frequency interference (RFI)
- Signals from other devices
- Self-heating due to resistance changes

- Signal conversion error
- Power sources

Electromagnetic compatibility (EMC) deals with the generation, transmission and reception of electromagnetic energy [83, pp. 3-10]. EMC can also cause interference in copper cables. During transmission with symmetrical copper cables, the external noise influences are counteracted by applying a differential signal to the two wires of the twisted copper cable. Ideally the different voltage between one wire and the other, common mode interference can be eliminated by using transformers (commonly referred to in this context as 'magnetics') at the points of connection to the network electronics. This is an important advantage in terms of EMC.

However, common modes cannot be completely eliminated in practice and very low interference fields remain. This can occur, for example, due to tolerances in the manufacturing process [84, pp. 283-291]. It may happen that common mode signals along the copper cable are partially converted to differential mode (DM) and vice versa. Due to an inaccurate twisting of the pairs the magnetic fields generated by the two wires are not mutually cancelled out. This phenomenon is called mode conversion [85].

Furthermore, poor EMC performance may result from non-ideal behaviour of circuit components due to unwanted conversion of differential mode to common mode (CM) and vice versa [84, pp. 283-291]. Current research on electromagnetic compatibility investigates the mode conversion of differential lines with a cross-section affected by geometric imbalance. In this context, an analogy to crosstalk is also detected [84, pp. 283-291].

A further problem can be caused by the terminating resistor. There is current research dealing with “the phenomenon of mode conversion as the basis of radiated emissions and radiated susceptibility” [86, pp. 1346-1349] of differential lines.

Even for terminal loads for Twisted Pair copper cable, which are terminated with a higher impedance than the characteristic impedance of the cable, the mode conversion increases significantly. With lower terminal loads as the characteristic impedance, a change occurs predominantly in the higher frequencies [81, pp. 126-131].

There are four different measurements to test the symmetry of Twisted Pair cables. The first measurement is called Transverse Conversion Loss (TCL) (figure 17). This measurement measures the mode conversion within a pair at the near end. A differential mode signal is fed into the Twisted Pair cable and the common mode signal is received and measured at the same end. The smaller the common mode signal, the better the symmetry of the cable [85].

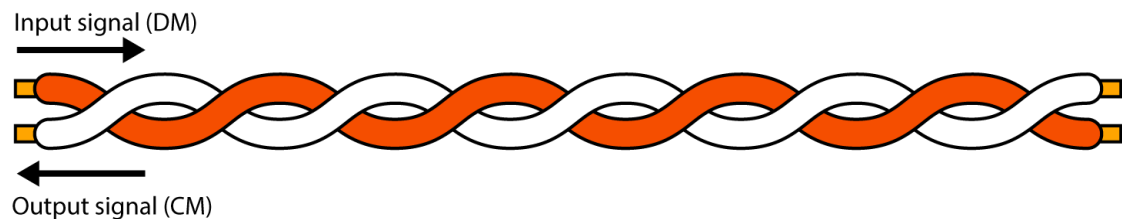

Figure 17 – Schematic illustration of TCL

The longitudinal conversion loss measurement (LCL) is the counterpart of this measurement (figure 18). A common mode signal is fed into the Twisted Pair cable and the differential mode signal is measured at the same end. The smaller the differential signal the better the symmetry of the cable [85].

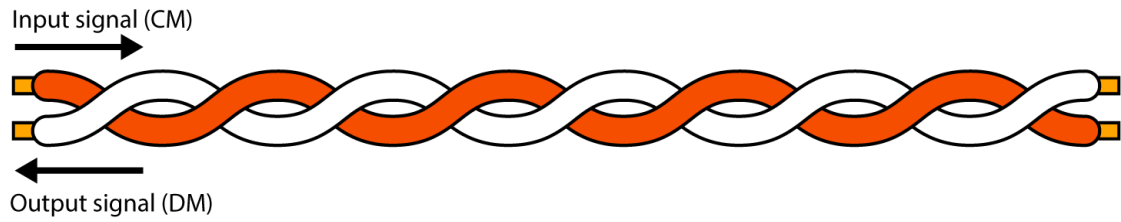

Figure 18 – Schematic illustration of LCL

The third measurement is a measurement at the far end of the cable. This measurement is called Transverse Conversion Transfer Loss (TCTL) (figure 19). A differential mode signal is sent into the near cable and the common mode signal is measured at the far end of the cable. Since this measurement is length-dependent, the Insertion Loss must be taken into account. The meaningful values of this measurement are called Equal Level Transverse Conversion Transfer Loss (ELTCL). Similar to the TCL measurement, the smaller the common mode signal at the far end the better the symmetry [85].

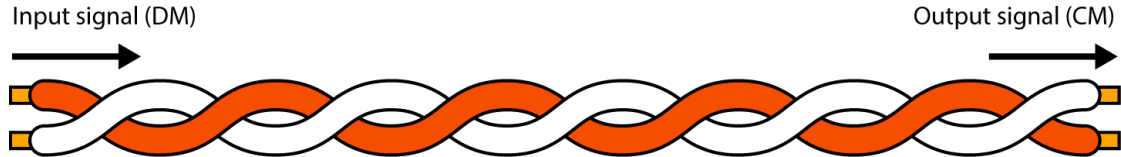

Figure 19 – Schematic illustration of TCTL

The Longitudinal Conversion Transfer Loss (LCTL) the counterpart to the TCTL measurement (figure 20). A common mode signal is sent at the near end and a differential mode signal is received at the far end [85].

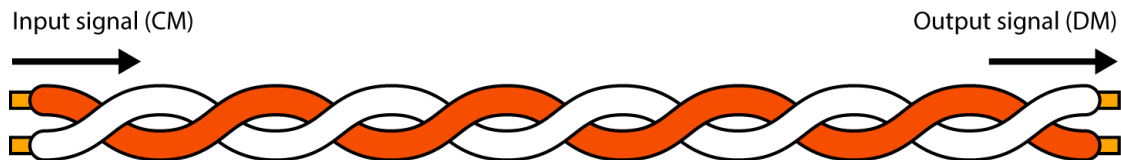

Figure 20 – Schematic illustration of LCTL

2.9 Need for 100 GBit/s

To achieve 100 GBit/s with a four pair Twisted Pair cable, the minimum transmission rate for one pair is 25 GBit/s per pair. 25 GBit/s with a PAM is a product of bits per symbol and signalling rate [87, pp. 10-122]. The maximum bandwidth of the cable classes is defined in the standardisations of ISO/IEC 11801 [76, pp. 7-16, 77, pp. 9-15, 27, pp. 8-13, 28, pp. 8-13]. Trying to transmit 100 GBit/s using existing cable Cat 5 with a maximum defined frequency range of 100 MHz, it assumes 200 M symbols per second. This would result in 125 bits per symbol, which means 2250 different levels of PAM. Assuming a transmission voltages of 2 V, the noise would need to be limited towards 0 V to ensure discriminative. This would be not practical because environmental noise is assumed to be -150 dBm/Hz [88, p. 31].

To achieve 25 GBit/s per pair by using 16 level of PAM it results in 4 bits per symbol [87, pp. 10-11]. For a PAM 16 transmission and a current of 2 V, the maximum signal would be more than -150 dBm/Hz and therefore a realistic value to ensure discriminative [88, p. 31]. By using 32 level of PAM it results in 5 bits per symbol. Also there the maximum signal would be more than -150 dBm/Hz and a realistic value to ensure discriminative [88, p. 31]. Therefore, at least the highest existing cable Cat 8.2 with a usable bandwidth of 2 GHz for PAM 32 and 3.125 GHz for PAM 16 is needed to transmit 100 GBase-T. The aim of the thesis is to achieve a data rate of up to 100 GBit/s over at least 10 m of cable. This will be done with the help of improving the data transmission for example by improving the equalization and the pre-emphasis. In order to do this the spectral cable performance must be investigated.

For the following measurements a copper cable was utilized, which fulfils the Cat 8.2. [27, pp. 8-13, 28, pp. 8-13]. The cable consists of eight insulated copper wires.

Communication Technologies and Copper Cables

Every two of the eight copper wires are twisted together as a pair. Each pair of the four Twisted Pairs has a foil shield. All pairs together have in addition a braided shielding. The length of the cable was set at 10 - 30 m. This represented a typical length for applications for data centres. Studies have shown that 80 % of the cabling in data centres is no longer than 30 m [23, p. 4]. Some connections are also shorter than 30 m. This offers the opportunity for data cables with higher bandwidths and shorter lengths.

3 Cable Analysis

In this chapter, the prototype cable is examined spectrally, the results of these measurements are presented and compared with the limit values of the cable categories. The significance of the measurements of the individual parameters is explained and the effects on data transmission are discussed. Furthermore, the relationship between cable structure, the lay length and Insertion Loss is discussed in more detail. Finally, a prediction of the Insertion Loss and a short summary of the cable analysis is presented.

3.1 Spectral Measurements of the Cable

Previous chapters have introduced the Insertion Loss and crosstalk of the copper cables. These properties and disturbances of copper cables are now examined in more detail. For this purpose, it is clarified how the spectral values are composed and how they are measured. The cable used in this thesis is presented and the spectral measurements are examined.

3.1.1 Measurement Setup for Spectral Measurements

The four spectral measurements shown below are Insertion Loss (IL), Return Loss (RL), Near End Crosstalk (NEXT) and Far End Crosstalk (FEXT). The measurements are made with a four port network analyser (E5061b) from Agilent.

Figure 21 shows the measurement setup with cable, test fixture and network analyser (see section 8.2.1). The cable was connected to the SMA connectors using a self-developed test fixture. The test fixture consists of a brass adapter and four SMA connectors. In addition, it consists of plastic plates to prevent a short circuit between the wire and the shielding. Finally, the cable is pressed against the brass adapter using a plastic holder to guarantee contact with the shielding (see section 8.3). It is important that the wires are soldered onto the SMA adapters as evenly as possible and with as little solder as possible. Irregularities and too much solder will cause reflections.

For the following measurements the cables are connected according to the respective measurement as described in section 2.7. The desired frequency range (here 1 MHz - 3 GHz) is then selected on the measuring instrument. Furthermore, the desired measurement bandwidth and the corresponding common mode or differential mode must be chosen. For the following measurements a 4-port measurement must be selected. The used network analyser has 1601 measurement points. If more measurement points are required, the measured frequency bandwidth must be divided into smaller bandwidths and then the individual measurements must be combined.

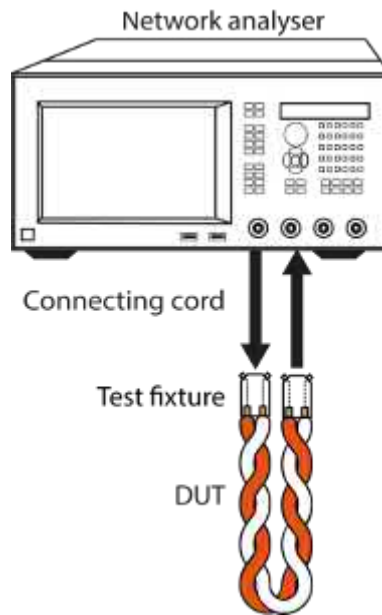

Figure 21 – Measurement setup for spectral measurements

3.1.2 Insertion Loss Measurement

The figure 22 shows the Insertion Loss measurement for the data cable used in later data transmission tests.

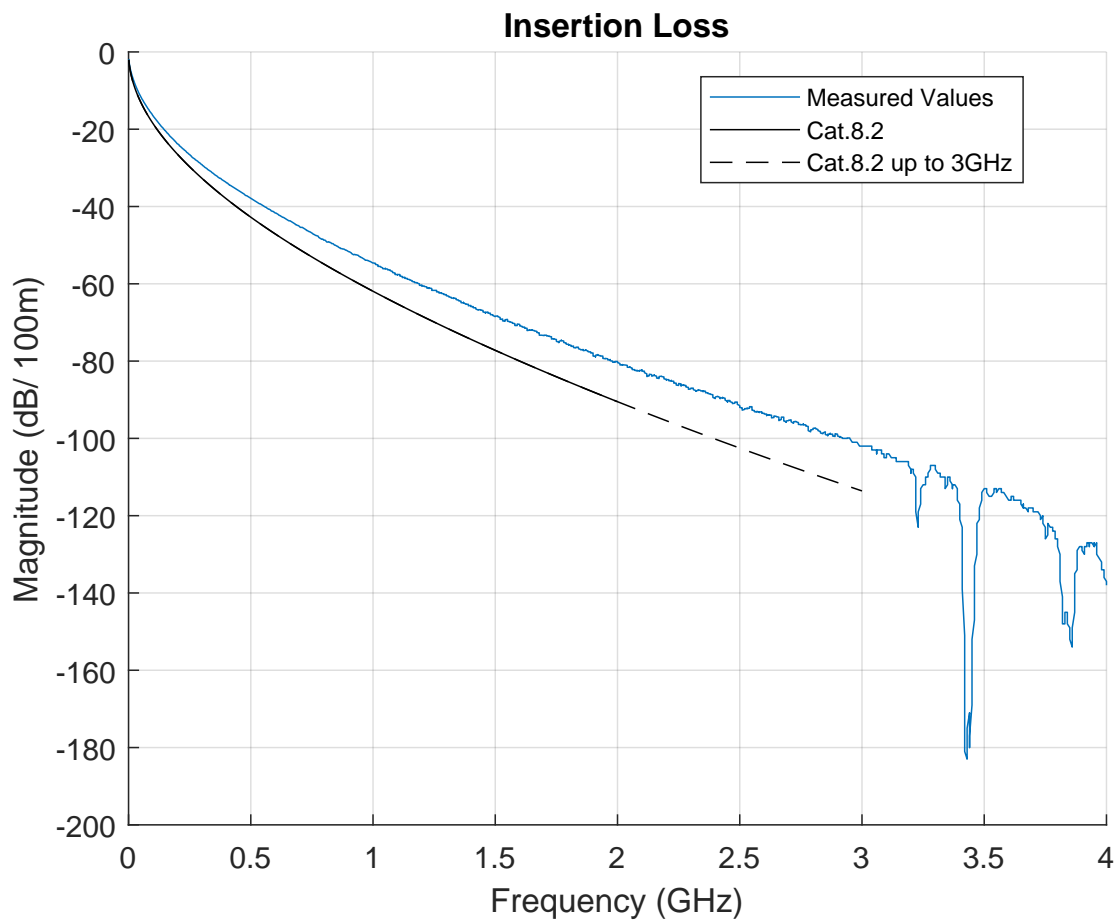

Figure 22 – Measurement of IL and cable category 8.2 up to 3 GHz

Figure 22 shows the measured Insertion Loss values. The setup of the measurement and the equipment used is described in section 3.1.1 . The abscissa is the frequency in GHz and the ordinate is power in dB/100m. In addition to the measured values of the Insertion Loss, the limit curve for cable category 8.2 according to ISO/IEC 11801 is also shown. In order to comply with the limit values, the measured curve must be above the limit curve and thus the values must be smaller than the limit values. As the figure shows, the limits for this cable have been met. The overall shape of the Insertion Loss is smooth. The Insertion Loss also increases with increasing frequency. The measurement shows clearly the low-pass behaviour of the cable.

The Insertion Loss increases smoothly up to a frequency of more than 3 GHz and remains above the extrapolated limits of cable category 8.2. The value of attenuation is about 100 dB at approximately 3 GHz. Compared with cable Cat 8.2, which is only defined up to 2 GHz, this cable has a very high usable bandwidth. The deep notch that can be seen at 3 GHz is often referred to in the Ethernet cable community as a "suck out", so for consistency, that term will be used in this thesis. These suck outs are due to the production and structure of the cable and are discussed in more detail in section 3.2.

3.1.3 Return Loss Measurement

Figure 23 shows the Return Loss measurement for the data cable used in following data transmission tests.

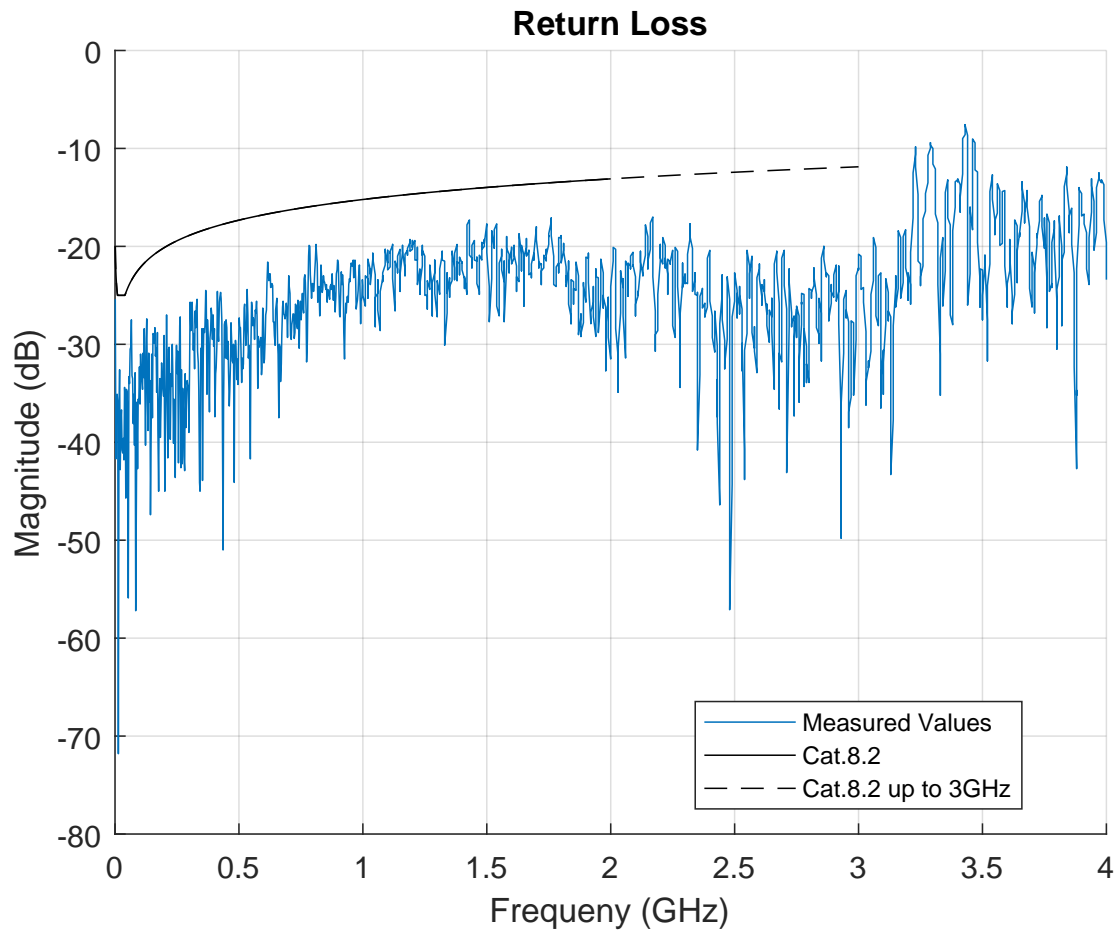

Figure 23 – Measurement of RL and cable category 8.2 up to 3 GHz

Figure 23 shows the measured Return Loss values. The setup of the measurement and the equipment used is described in section 3.1.1. The abscissa is the frequency in GHz and the ordinate is the ratio between the incident power and the reflected power in dB/100m. In addition to the measured values of the Return Loss, the limit curve for cable category 8.2 according to ISO/IEC 11801 is also shown. In order to comply with the limit values, the measured curve must be below the limit curve. As the figure shows, the limits for this cable have been met. Only above a frequency of 3.2 GHz larger suck outs are present. However, since the limit values are only defined up to 2 GHz, the cable meets the standard.

3.1.4 Near End Crosstalk Measurement

The figure 24 shows the Near End Crosstalk for the data cable used in following data transmission measurements.

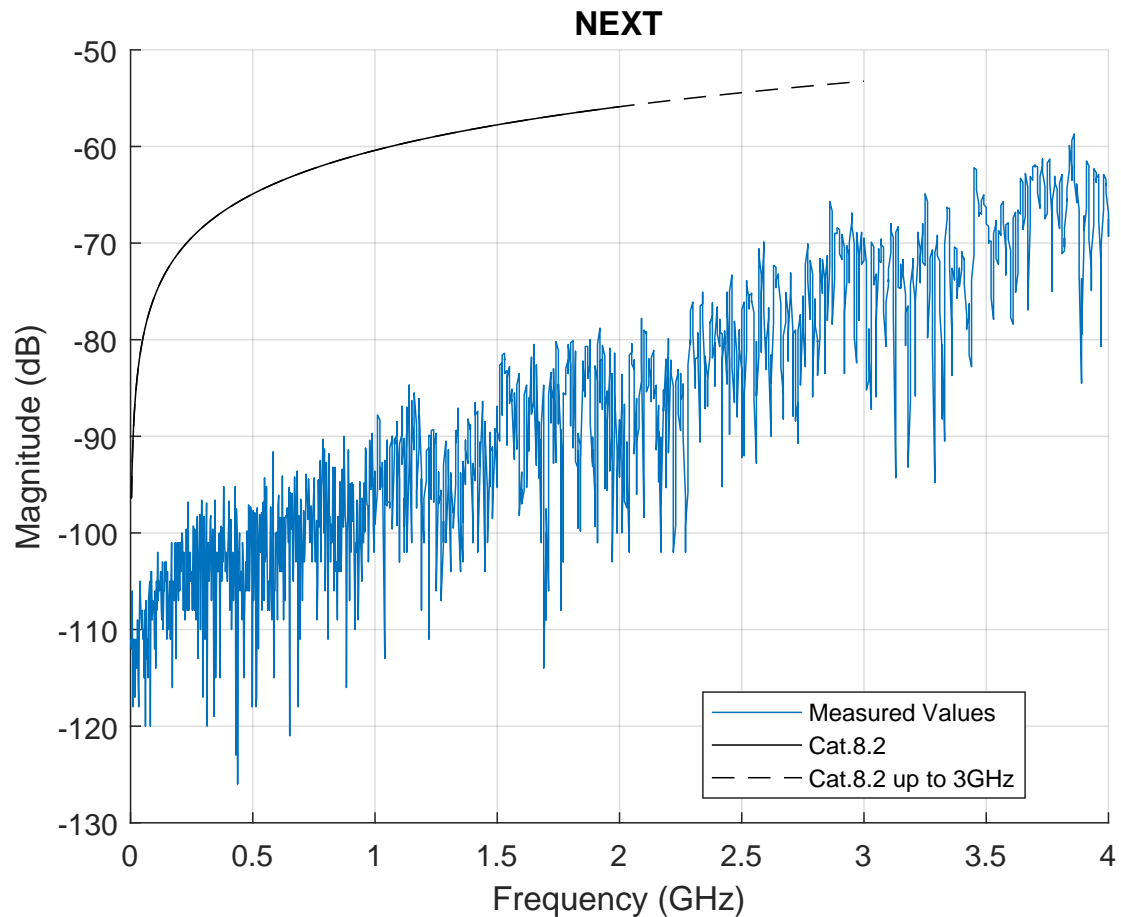

Figure 24 – Measurement of NEXT and cable category 8.2 up to 3 GHz

Figure 24 shows the measurement of the Near End Crosstalk. The abscissa is the frequency in GHz and the ordinate the power in dB/100m. Due to the good foil shielding, the influence of NEXT at a bandwidth of up to 3 GHz is not more than -75 dB. Due to this small influence, the NEXT will not be examined in detail below. In addition to the Near End Crosstalk measurements, the limit curve for cable Cat

8.2 according to ISO/IEC 11801 is also shown. To comply with the limit values the trace must be below the limit curve. As the figure shows, the limits for this cable have been adhered to and there are additional reserves. The cable therefore complies absolutely with the standard.

3.1.5 Far End Crosstalk Measurement

Figure 25 shows the Far End Crosstalk for the data cable used in following data transmission measurements.

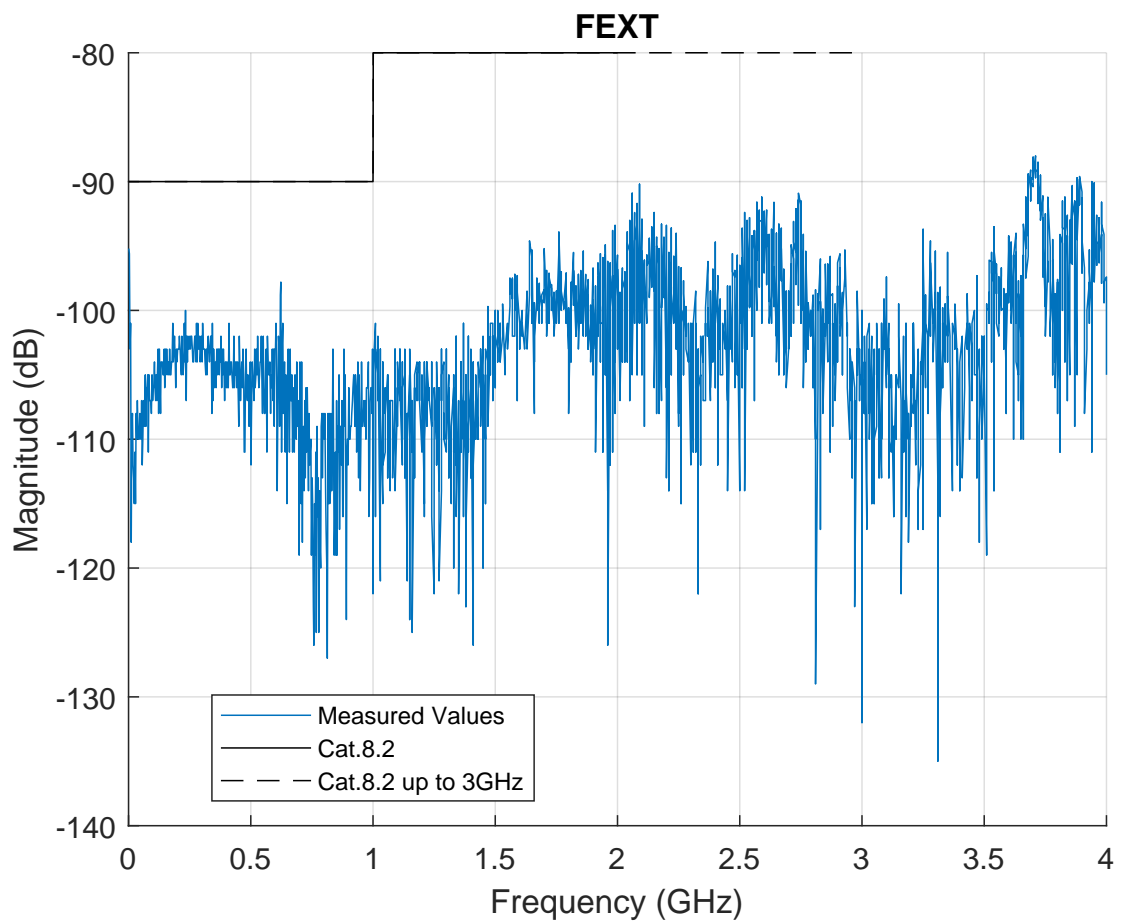

Figure 25 – Measurement of FEXT and cable category 8.2 up to 3 GHz

Figure 25 shows the measurement of Far End Crosstalk. The abscissa is the frequency in GHz and the ordinate the power in dB/100m. Due to the very good foil shielding of the individual pairs, the FEXT value is very low. Up to a bandwidth of 3 GHz, the value is never more than 90 dB. Due to this small influence, the FEXT value is not considered further in the following. In addition to the Far End Crosstalk measurements, the limit curve for the corresponding cable Cat 8.2 according to ISO/IEC 11801 is also shown. In order to comply with the limit values, the trace must be below the limit curve. As the figure shows, the limit values for this cable have been complied with. The cable therefore complies with the standard.

3.2 Reduction of Insertion Loss Suck Out During Cable Production

Section 2.9 has shown that the transmission of 100 GBit/s over a 30 m cable requires a theoretical bandwidth of 2.5 - 3 GHz. So far, the highest frequency standardized cable category is 8.2, which is standardized up to a bandwidth of 2 GHz. Increasing the bandwidth from 2 GHz to 3 GHz is extremely difficult. In particular the crosstalk and attenuation properties competing in this high frequency range are problematic in the development of cables with such a high bandwidth. The higher the frequencies the more Insertion Loss the cable has. Furthermore, the crosstalk increases at higher frequencies.

As already shown in section 2.7.1, the Insertion Loss is limited by the skin-effect (low pass behaviour) and in addition by the suck outs, see fig. 22 - at a frequency of about 3.5 GHz. The main focus to improve the cable must be on these suck outs. The suck outs are frequency-dependent outliers. These electrical inhomogeneity are caused by the lay lengths of the pairs. In addition, this is reinforced by the electrical interactions between the required main strand lay length in relation to the lay lengths of the pairs [89, pp. 1-12]. The undesired suck out are caused by regular mechanical displacements during the stranding process. The distance between the mechanical displacements as a function of the stranding lay lengths ultimately determines the frequencies at which the electrical suck outs occur.

In order to predict the undesired suck outs cable manufacturers have developed different simulations. Using these simulations cable manufacturers can make specific machine selection and machine settings. The simulations are based on the knowledge that the suck outs are caused by mechanical displacements during the cable production.

The formula for determining the main stranding suck out, which should be above 3 GHz, is determined as follows [90, pp. 1-20]:

$$L_{\text{Suckout}} = \frac{c_0}{2f\sqrt{\epsilon_r}} \quad (5)$$

c_0 stands for the speed of light, f for the frequency and ϵ_r for the effective permittivity of the dielectric, thus the dielectric properties of the insulation material. The formula shows that by shortening the main strand lay length the main electrical suck out of the Insertion Loss can be shifted to higher frequencies. However, it should be noted that shortening the main stranding length leads to the conductor becoming longer. The extension of the copper conductor increases the Insertion Loss over the entire frequency response. It also affects the propagation time.

When producing the prototype cable used in this thesis these new findings were taken into account. The structure of this prototype cable is as follows:

The conductor consists of bare copper wire with a diameter of 0.7 mm. The insulation of the individual conductors consists of a polyethylene foam skin. The diameter of the conductor with the insulation is 1.9 mm. The foil shield of the individual pairs is aluminium-laminated polyethylene foil. The metal side is directed outwards. The total shield of the four pairs consists of tinned copper braiding. The outer sheath is a halogen-free, flame-retardant compound. The main stranding tip of this prototype cable is about 3.2 GHz [90, pp. 1-20]. The lay lengths of the individual pairs and the main stranding are not specified by the manufacturer for competitive reasons.

3.3 Relationship Between Lay Length and Insertion Loss

By twisting the wires into a Twisted Pair, interference voltages can be almost completely eliminated by differential transmission and subsequent summation. This reduces crosstalk and makes the transmission less susceptible to inductive interference. Furthermore, by minimizing the pair and main cable lengths the Insertion Loss suck out is shifted to higher frequencies. This results in a larger usable bandwidth for data transmission.

Due to the tighter twisting the actual wire of a 100 m long cable, for example, becomes longer [91, p. 5]. This can be calculated as follows. The radius resulting from the twisting can be determined by the radius of the wire and its insulation (r_1). This results in a circumference (C) of:

$$C_1 = 2 \cdot r_1 \cdot \pi \quad (6)$$

Figure 26 shows a schematic drawing of the twisting of a pair. It shows the length of a twist L_1 and the circumference C .

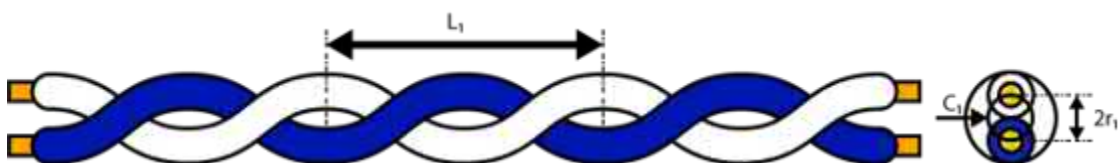

Figure 26 – Schematic Twisted Pair length

The actual wire length (WL) results from the length of a whole twist (L_1) and the extent of the twist.

$$WL = \sqrt{(2 \cdot r_1 \cdot \pi)^2 + (L_1)^2} \quad (7)$$

For a Twisted Pair with a length of 100 m this results:

$$TPL_{100} = 100 \cdot \frac{\sqrt{(2 \cdot r_1 \cdot \pi)^2 + (L_1)^2}}{L_1} \quad (8)$$

For a wire with insulation with a radius of 1 mm and a twisting length of 20 mm, this results in an actual length of 104.82 m instead of 100 m. With a radius of also 1 mm, but a twisting length of 10 mm, this results in an actual length of 118.10 m. This means that the wire is 13.28 m longer than the 20 mm twisting length. This corresponds to a 12.67 % longer wire. This effect is further intensified during the main stranding, i.e. during the twisting of all four pairs. A Twisted Pair does not produce a uniform diameter. However, a rough estimate of the actual length of the wire after the main stranding can be made using the following calculation.

The radius that must then be used is also twice the radius of a wire with insulation or once the diameter of a wire and its insulation multiplied by the root of two. The length of an entire twist is the main rope length and the resulting wire length is then the actual length of a Twisted Pair.

Figure 27 shows the schematic drawing of the twisting of several pairs. For reasons of simplification, a schematic representation of two Twisted Pairs is shown. However,

this is the same for four pairs. It shows the length of a twist L_2 of two pairs and diameter of four Twisted Pairs.

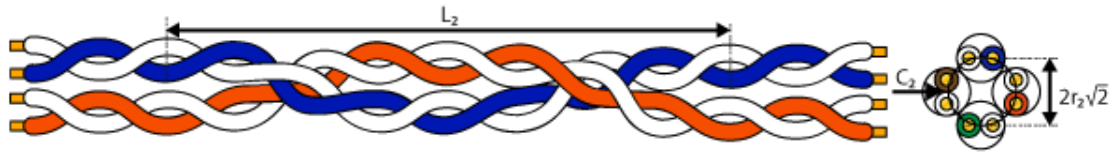

Figure 27 – Schematic main stranding length

When the calculation of these Twisted Pairs and the main stranding of four identical pairs is combined, an actual wire length of 100 m results:

$$\text{MWSL}_{100} = 100 \cdot \frac{\sqrt{(2 \cdot r_2 \cdot \sqrt{2} \cdot \pi)^2 + (L_2)^2}}{L_2} \cdot \frac{\sqrt{(2 \cdot r_1 \cdot \pi)^2 + (L_1)^2}}{L_1} \quad (9)$$

The example from above had a wire radius of 1 mm and a twisting length of 10 mm for a pair. Taking this example and a main stranding of 30 mm, this results in an actual wire length of 137.27 m for a cable with a length of 100 m.

The longer wire also increases the attenuation of the cable. This effect can be imagined as a series connection of resistors. When more resistors are connected in series, the total resistance also increases.

3.4 Prediction of the Insertion Loss

The Insertion Loss (a) of inner conductor of cable on the basis of the diameter (d) and the characteristic impedance (Z) can be estimated very roughly by the following formula [92]:

$$a = 0.435 \cdot \sqrt{\frac{f}{Z \cdot d}} \quad (10)$$

The result is the attenuation in dB for 100 m cable. However, this estimate is very rough and should be adapted to the measurement results. The formula shows that the larger the wire diameter the smaller the Insertion Loss.

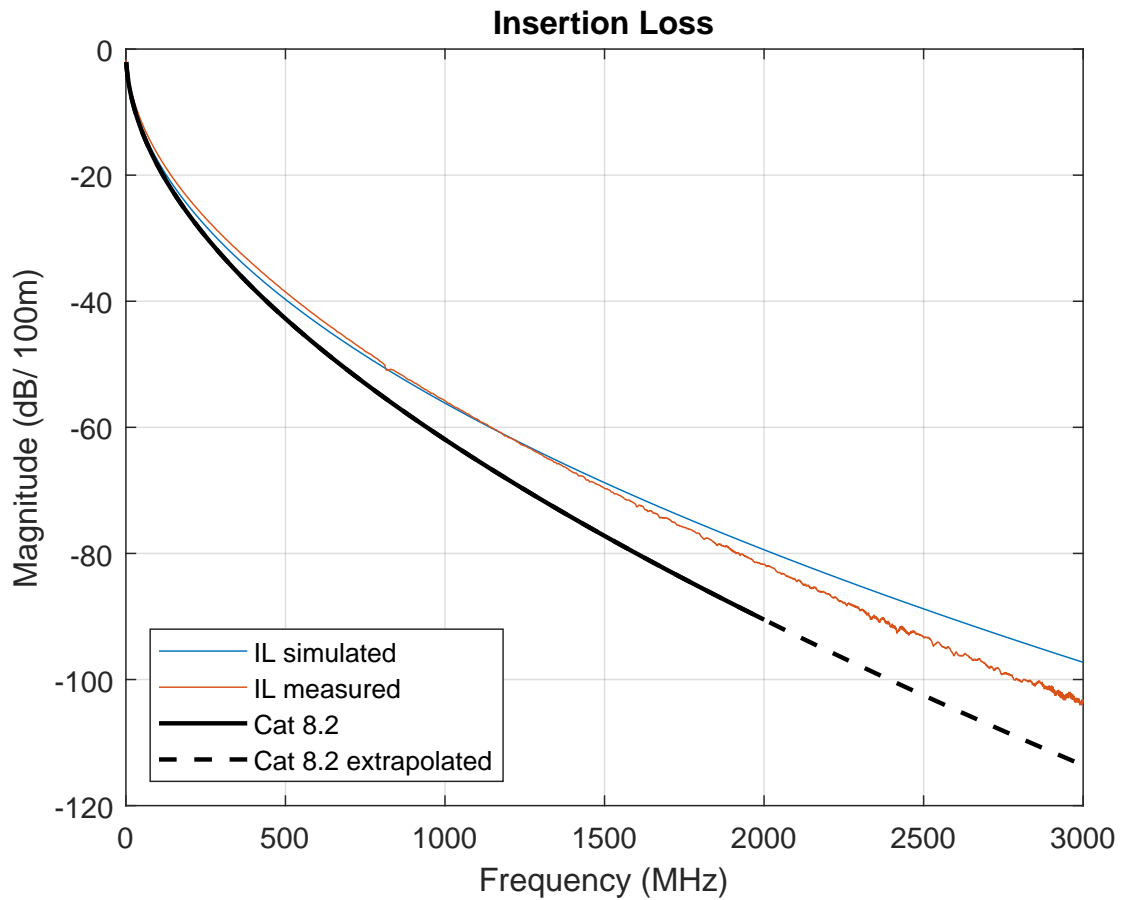

Figure 28 – Simulated and measured IL and cable category 8.2 up to 3 GHz

Figure 28 shows the simulation and measurement of Insertion Loss over frequency. The ordinate is the magnitude in dB. In addition to the simulated and the measured line, the category 8.2 cable limit line is drawn in black. These limits were extrapolated from 2 to 3 GHz.

The measured curve in pink complies with the limits of Cat 8.2. The higher the frequencies the greater the margin to the Cat 8.2 limits. The simulated and the measured curve fit well together in the lower frequency range between 1 and 2,000 MHz. However, in the upper frequency range between 2,000 MHz and 3,000 MHz, the

difference is up to 5 dB. The simulated line and the measured line are not congruent. However, the simulation can be used as a guideline.

3.5 Summary of the Cable Analysis

In this chapter the spectral properties of the cable were measured and investigated. These properties are very important for later data transmission. Especially the attenuation has a big influence on the data transmission. Due to the low-pass behaviour of the cable the high frequencies are attenuated more than the lower frequencies. This means that the transmitted symbols cannot be demodulated without equalization.

The attenuation behaviour was therefore examined in more detail. The frequency suck outs are a significant problem in cable production. These are large decreases in the frequency characteristic and result from electrical interactions between the main stranding lay lengths in relation to the lay lengths of the pairs.

During the stranding process regular mechanical displacements of the cable are caused. The distance between the mechanical displacements as a function of the stranding lay length ultimately determines the frequencies at which the electrical suck outs occur.

Section 3.3 shows that the shorter the main rope length, the higher the frequencies at which the main electrical suck out occurs. This knowledge makes it possible to produce copper cables with a higher bandwidth. It should be noted, however, that the shorter the stranding lay length and the shorter the lay length, the longer the copper cable becomes and the Insertion Loss increases. This relationship and a calculation of the resulting cable length is described in more detail in section 3.3.

Finally, section 3.4 presented a prediction of the frequency characteristic of the Insertion Loss on the basis of wire diameter and characteristic impedance.

4 Modulation and Simulation of Data Transmission

This chapter deals with the modulation scheme. The Pulse Amplitude Modulation and the Raised Cosine filter is presented. Afterwards, the Pseudorandom Binary Sequence is presented.

Furthermore, data transmission is simulated theoretically. First the transmission of a PAM 16 coding with Raised Cosine filter is simulated. This original simulation is then used as a reference for the following simulations. As a second action, a simulation of the signal at the end of the copper cable is generated. This shows the influence of the attenuation. Finally, a pre-emphasized signal is generated, which at the end of the Twisted Pair cable should correspond to the original signal sequence again.

4.1 Pulse Amplitude Modulation (PAM) and Raised Cosine (RC) Filter

The (theoretical) rectangular pulse is the most basic signal in a digital transmission scheme. With rectangular pulses both amplitude A and duration T are fixed. With a higher order Pulse Amplitude Modulation the pulse amplitude can assume both positive and negative values. Furthermore, several discrete amplitudes are used. Thus several bits per pulse can be transmitted. For example, with a Pulse Amplitude

Modulation scheme with four levels, two bits per pulse (or symbol) can be transmitted. In the later measurements, predominantly higher order Pulse Amplitude Modulations are used. These are PAM 8 with three bits per symbol, PAM 16 with four bits per symbol and PAM 32 with five bits per symbol [93, p. 1].

Figure 29 shows 100 symbols of such a Pulse Amplitude Modulation with 16 levels. The amplitude is between $A = +1V$ and $A = -1V$. The duration of one symbol is $T = 4 \cdot 10^{-8}$ s. A sequence of such pulses is offset by the duration of one pulse each. In this transmission, the information is contained in the amplitude of the pulse. The pulse rate is $\frac{1}{T}$ pulses per second. The symbol rate is therefore $\frac{1}{T}$ symbols per second [93, p. 1]. For the later transmission an external cable is used for triggering.

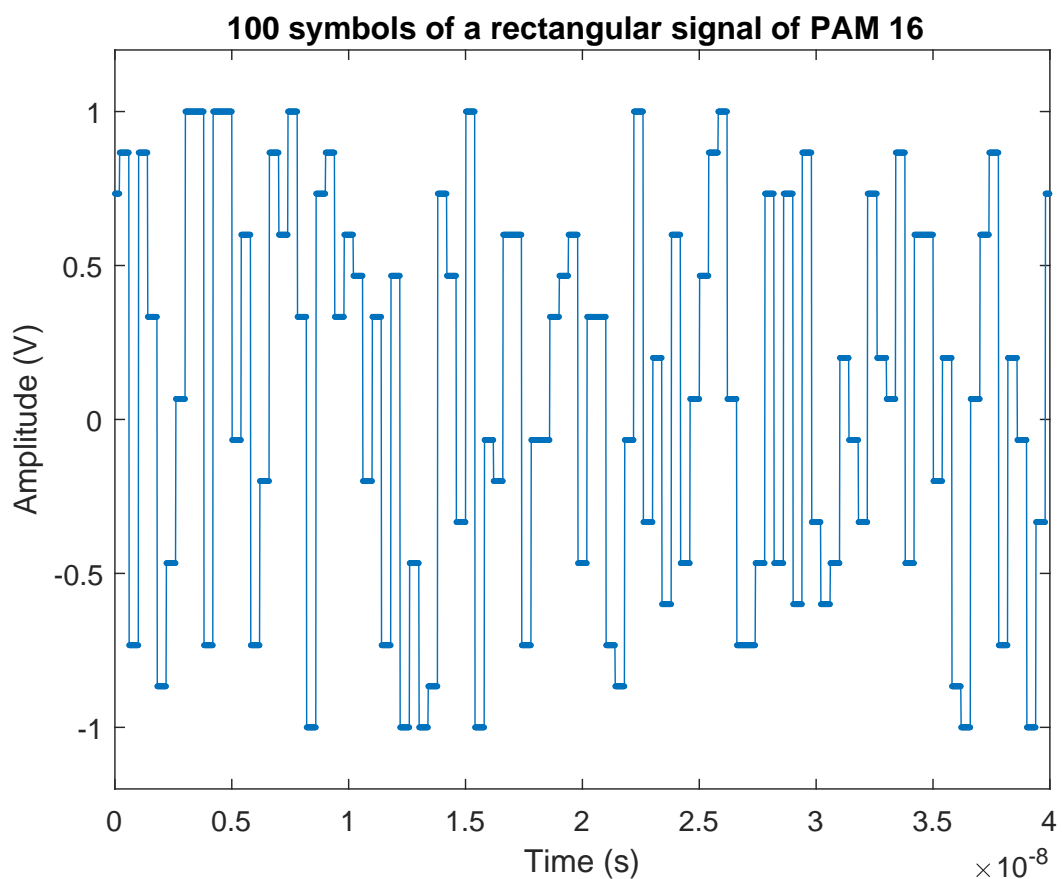

Figure 29 – 100 symbols of PAM 16 (40 GBit/s), rectangular pulse

The number of symbols transmitted per second is also called baud rate. The data rate in bits per second results from the baud rate multiplied by the number of bits per symbol [93, p. 1].

$$\text{Data rate} = \frac{\text{Baud rate} \cdot \text{Number of bits}}{\text{symbol}} \quad (11)$$

In the example with PAM 16, each symbol consists of four bits. The bit rate is therefore four times the symbol rate. By higher order Pulse Amplitude Modulations it is possible to reduce the transmission rate for the transmission compared to binary transmission but this forms a compromise between the advantages of more bits per symbol with the disadvantage of noise being more significant due to the smaller difference in levels.

The spectrum of the symbol sequence from figure 29 is shown in figure 30. The spectrum of a signal sequence is created by the Fourier transform. The abscissa is the frequency in MHz. The ordinate is the relative power per frequency in dB/Hz.

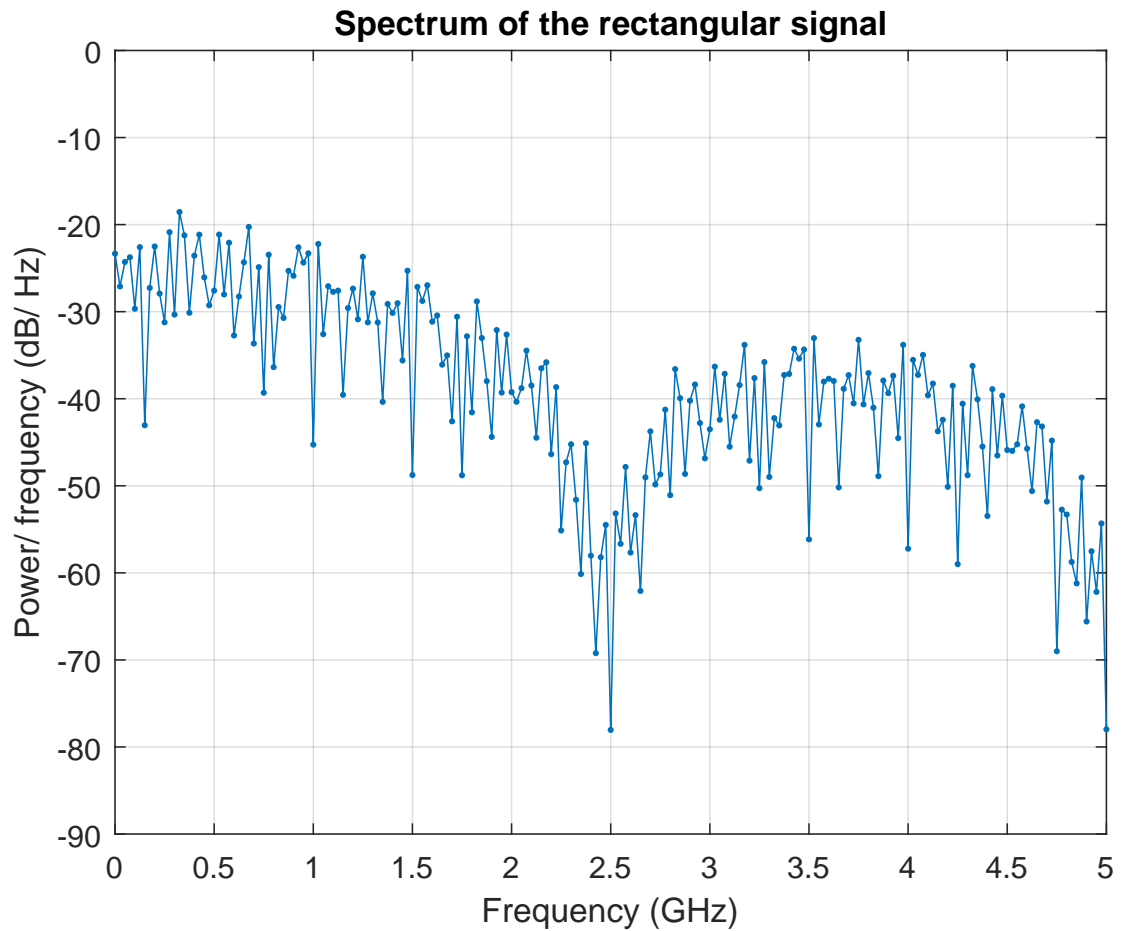

Figure 30 – Spectrum of PAM 16 (40 GBit/s), rectangular pulse

The spectrum of the rectangular pulse extends over an infinite frequency [93, pp 1-4]. However, in many data transmission applications the bandwidth of the transmission must be limited. When transmitting with a copper cable, the bandwidth is limited by the suck outs in the Insertion Loss above a certain bandwidth. Transmission with a rectangular pulse is therefore not possible. The bandwidth of a rectangular pulse can be reduced by using a low-pass filter. This filter changes the pulse shape to a round shape. This process is often referred to as pulse shaping [93, pp 3-4].

A well-known filter is the Raised Cosine (RC) Filter. Its frequency response is given by [93, pp 3-4]:

$$H(\omega) = \begin{cases} \tau, & 0 \leq \omega \leq c \\ \tau \left\{ \cos^2 \left(\frac{\tau(\omega-c)}{4\alpha} \right) \right\}, & c \leq \omega \leq d \\ 0, & \omega > d \end{cases} \quad (12)$$

ω is the radian frequency with $2 \cdot \pi \cdot f$. τ stands for the pulse period and α is the roll off factor. The roll off factor is between $0 \leq \alpha \leq 1$. c is equal to $\frac{\pi \cdot (1-\alpha)}{\tau}$ and d is equal to $\frac{\pi \cdot (1+\alpha)}{\tau}$ [93, pp. 3-4].

The signal sequence shown in figure 29 with 100 pulse amplitudes combined with the Raised Cosine filter is shown in figure 31. The pulse shape is no longer rectangular but smoothed. The corresponding spectrum of figure 31 is shown in figure 32.

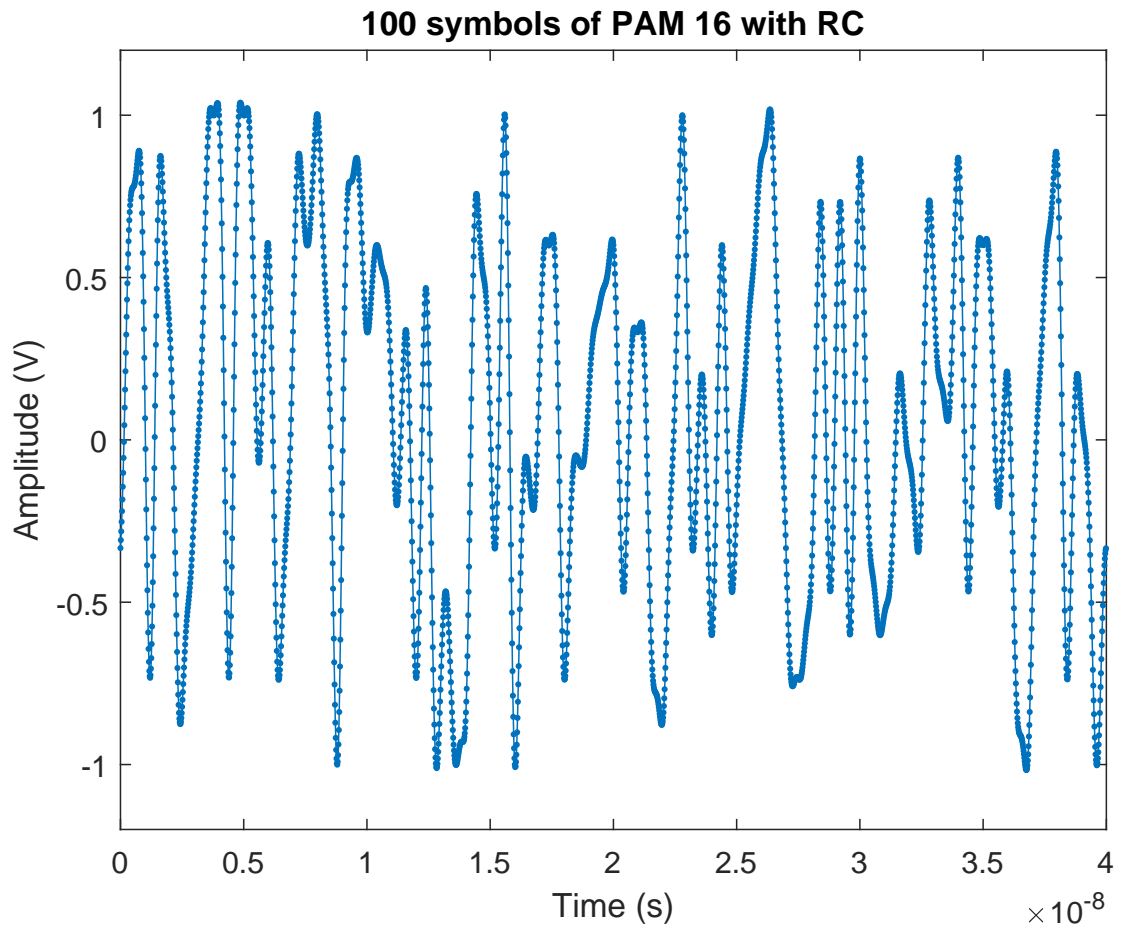

Figure 31 – 100 symbols of PAM 16 (40 GBit/s), RC

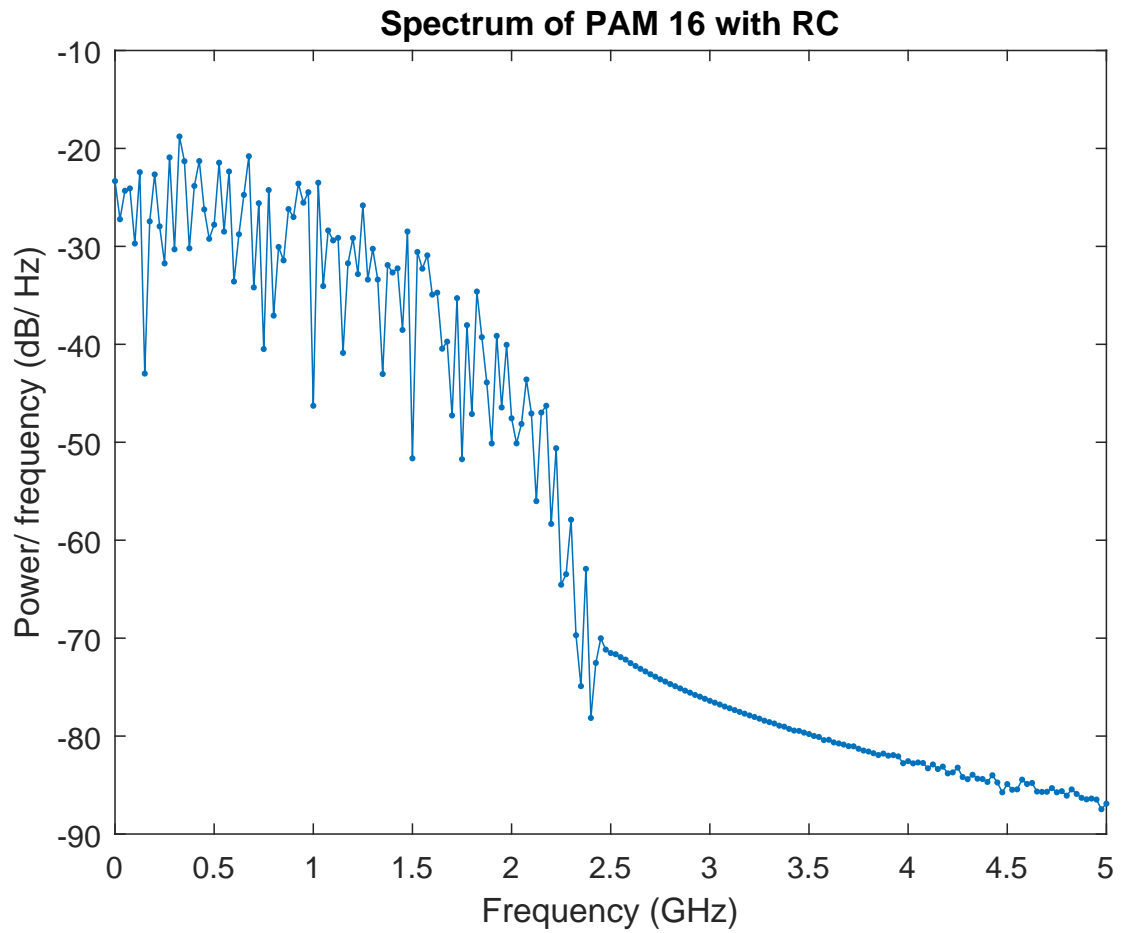

Figure 32 – Spectrum of PAM 16 (40 GBit/s), RC

From a frequency of 2.5 GHz, the spectrum is significantly smaller than the spectrum of the square wave signal.

4.2 Pseudorandom Binary Sequence

The test sequence is based on a Pseudorandom Binary Sequence (PRBS). The PRBS sequence is a research-approved sequence for tests with input signals.

To verify that each combination of two consecutive symbols is present in the PRBS transmitted input signal, 4096 symbols of a PAM 16 signal were combined with the following symbol and presented in a two dimensional diagram. For this purpose 16 values between $0 \leq x \leq 1$ were used. In addition, a frequency of the occurring combination was represented by a colour scheme. This diagram shows figure 33.

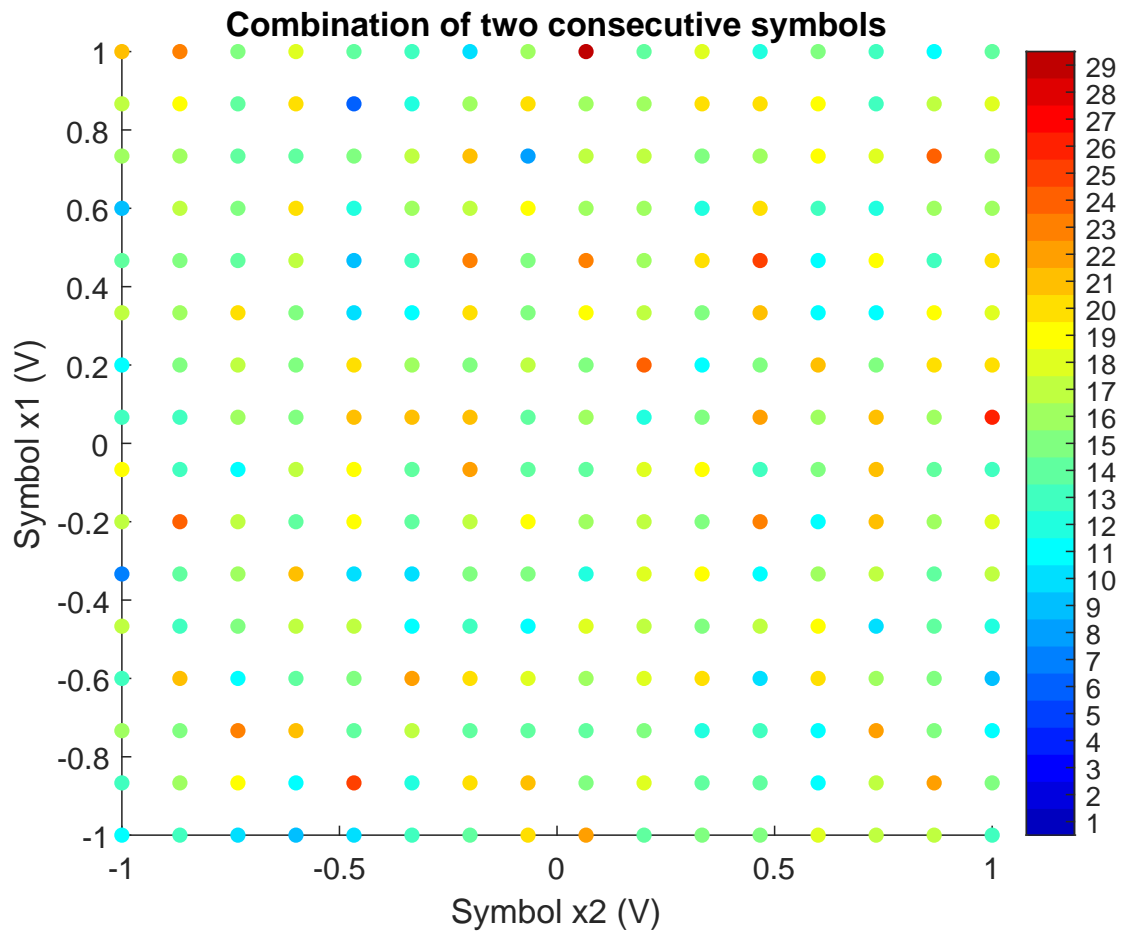

Figure 33 – Combination of two consecutive symbols

Figure 33 shows that all 256 combinations of two consecutive symbols are represented. Furthermore, the evaluation shows that 90 % of all combinations occur between 10 and 21 times (see section 8.4 for more details). Thus it can be stated that the input sequence shows all pair combinations and has quite a good frequency distribution.

4.3 Simulation of the Original Signal

The chapter 3 showed the spectral measurements of the cable. Particularly important for the data transmission is the Insertion Loss of the cable. To counteract the typical low-pass behaviour of the copper cable, pre-emphasis is necessary. For this purpose a mathematical method is used. The mathematical emphasis uses the spectral measurement of the Insertion Loss of the Twisted Pair cable to create a corresponding high-pass filter.

To explain the principle of pre-emphasis, the following example shows a PAM 16 transmission over a 10 m long copper cable. The example has a data rate of 40 GBit/s over a four pair copper cable. In the following, the transmission via one pair of a four pair copper cable is always considered. In order to achieve a transmission rate of 40 GBit/s over a four pair copper cable, 10 GBit/s must be transmitted over one pair. With a PAM 16 modulation, each symbol corresponds to 4 bits. This results in a transmission of 2.5 GBd with a PAM 16 modulation. Figure 31 shows an example of such a transmission.

Figure 31 shows a 100 symbol long simulated sequence of a PAM 16 RC modulation with a data rate of 10 GBit/s. These 100 symbols are random signal sequences. The abscissa represents the time in seconds. It shows a time span of 40 ns. One of the 100 symbols is 400 ps. The ordinate represents the voltage in volts. The maximum positive voltage is 1 V. The minimum negative voltage is -1 V. The different amplitudes represent the different levels of PAM 16 coding.

Figure 32 shows the corresponding spectrum of the signal sequence. The abscissa is the frequency in GHz. The ordinate is the relative power per frequency in dB/Hz. The figure shows that the main frequency component of this signal sequence lies in the frequency range between 0 and 2.5 GHz.

The curve in figure 31 and the spectrum of figure 32 show the optimal transmission of a PAM 16 modulation with Raised Cosine filter. This sequence should therefore be demodulated without any error.

To confirm that statement and to make a statement about the possibility of demodulation and the quality of these symbols, all 100 symbols of the signal sequence are overlaid in the following. In this way, the corresponding Eye Pattern of this sequence is created.

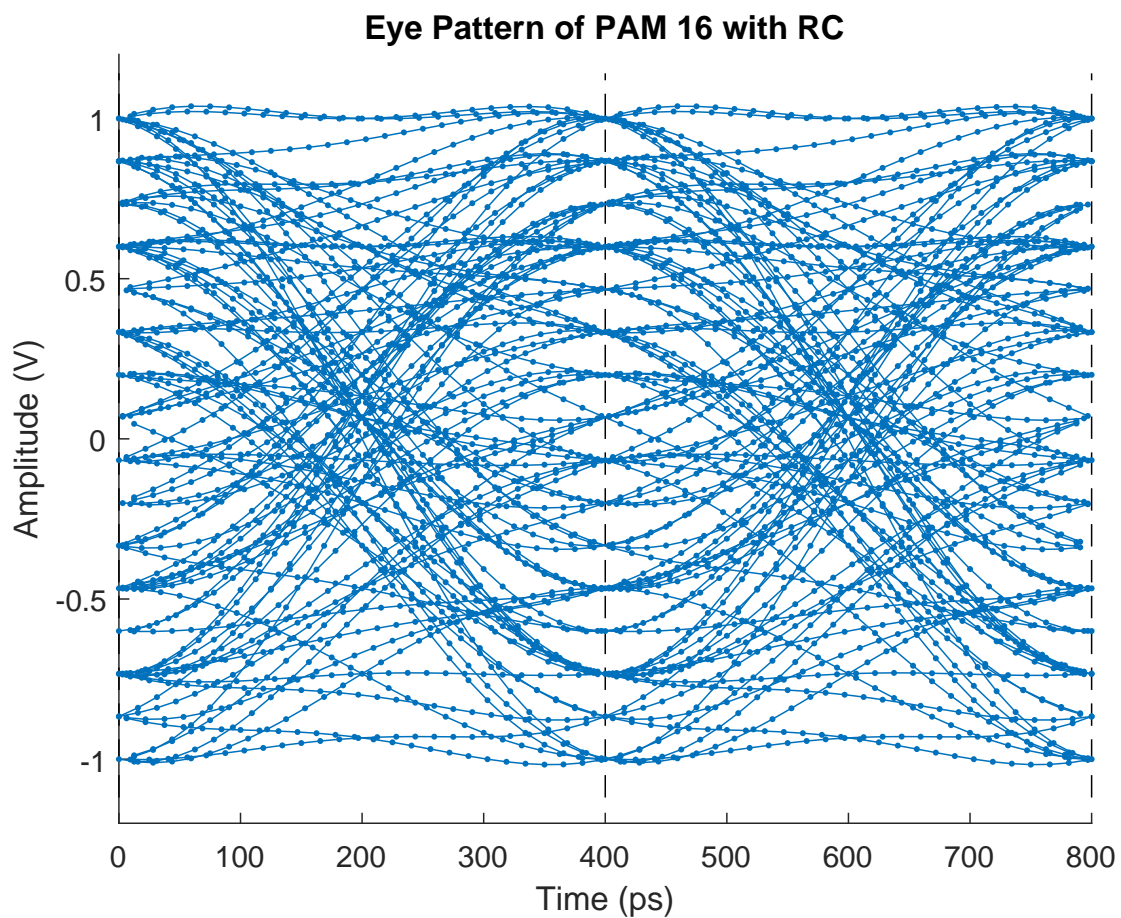

Figure 34 – Eye Pattern of PAM 16 (40 GBit/s), RC

Figure 34 shows the corresponding Eye Pattern of the signal sequence of figure 31. The abscissa shows the time again. It is given in picoseconds. The complete time

Modulation and Simulation of Data Transmission

span is 800 ps. This corresponds to two symbols. The ordinate represents voltage as in the previous representation and is given in volts.

The illustration clearly shows that there are 15 eyes in the middle of the figure. This position represents the centre of all 100 symbols. At this point the individual symbols can be distinguished from each other. The so-called "eyes" of the Eye Pattern are wide open and it should be possible to demodulate error-free at this point.

4.4 Simulation of the Signal at the End of the Cable

When the signal is now transmitted via a 10 m long copper cable, the signal is changed by the transmission properties of the cable [94, pp. 103-105]. As already mentioned, the Insertion Loss plays a major role here. Due to the attenuation of the cable, lower frequencies are now attenuated less than higher frequencies. This leads to an imbalance. As a result, it is no longer possible to demodulate the received signal sequence without further work. This becomes clear in the following figure.

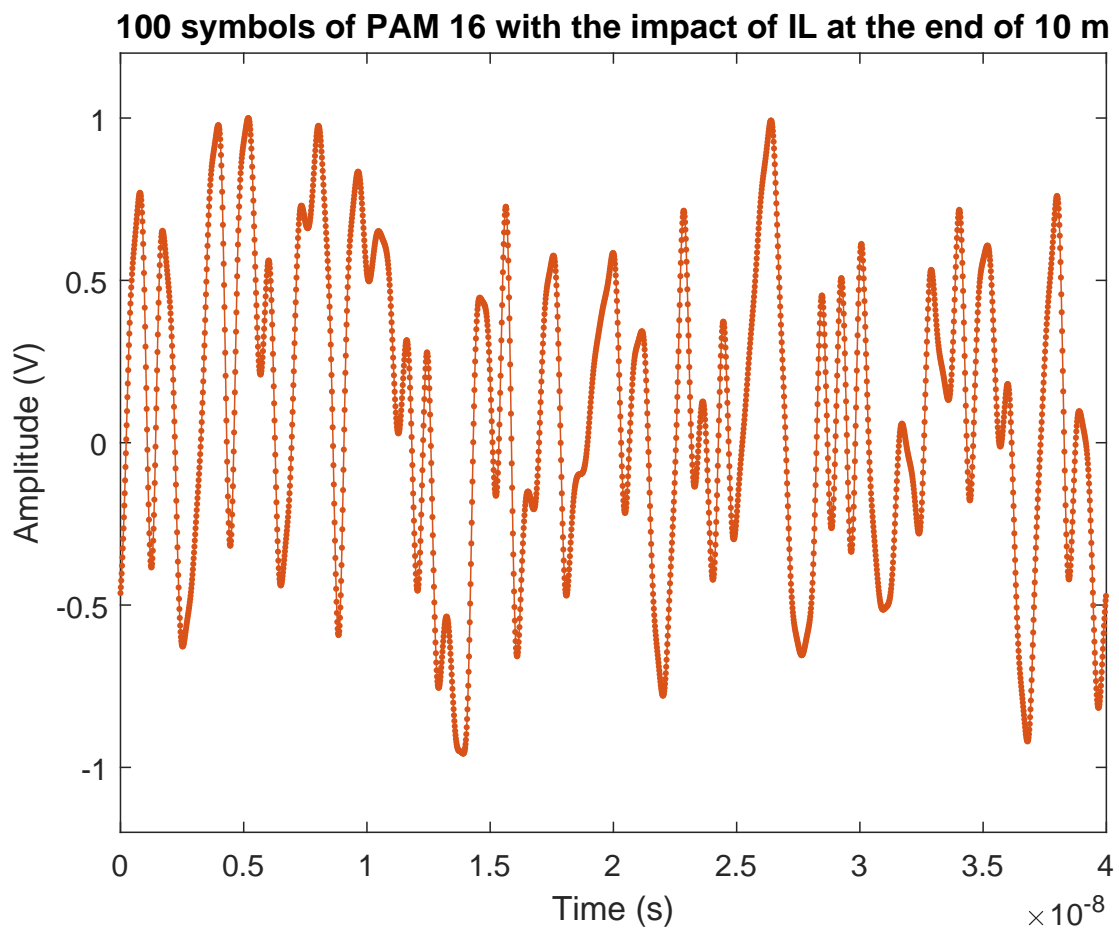

Figure 35 – 100 symbols of PAM 16 (40 GBit/s), with impact of IL (10 m)

Figure 35 shows the simulation of the same random signal sequence as in figure 31. However, the influence of the 10 m long copper cable has now been taken into account. The abscissa is again the time in seconds and the ordinate is the voltage in volts. The lengths of the axes also correspond to those shown in figure 31.

At first view, the figure looks very similar to the original signal sequence. However, the individual symbols are now "rounder" than above. This is due to the fact that the high frequency components are now significantly attenuated and less than in the original signal sequence.

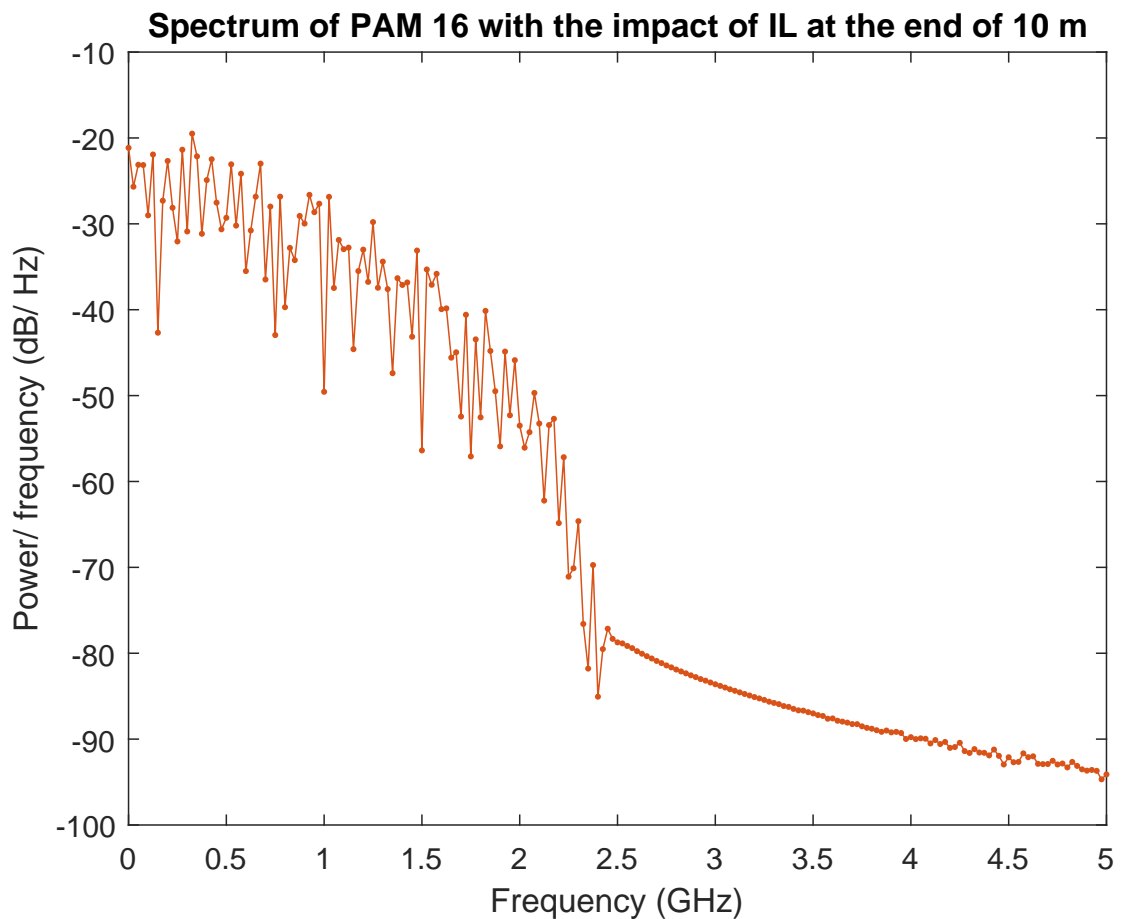

Figure 36 – Spectrum of PAM 16 (40 GBit/s), with impact of IL (10 m)

Figure 36 shows the spectrum of the simulated signal sequence at the end of the copper cable. The abscissa shows the frequency in GHz from 0 to 5 GHz. The ordinate shows the relative power per frequency in dB/Hz from 0 to -100 dB. As with Figure 33 the largest frequency component is in the range between 0 and 2.5 GHz. At first view, the spectrum looks similar to the spectrum of the original transmission. However, the high frequency components are lower than before.

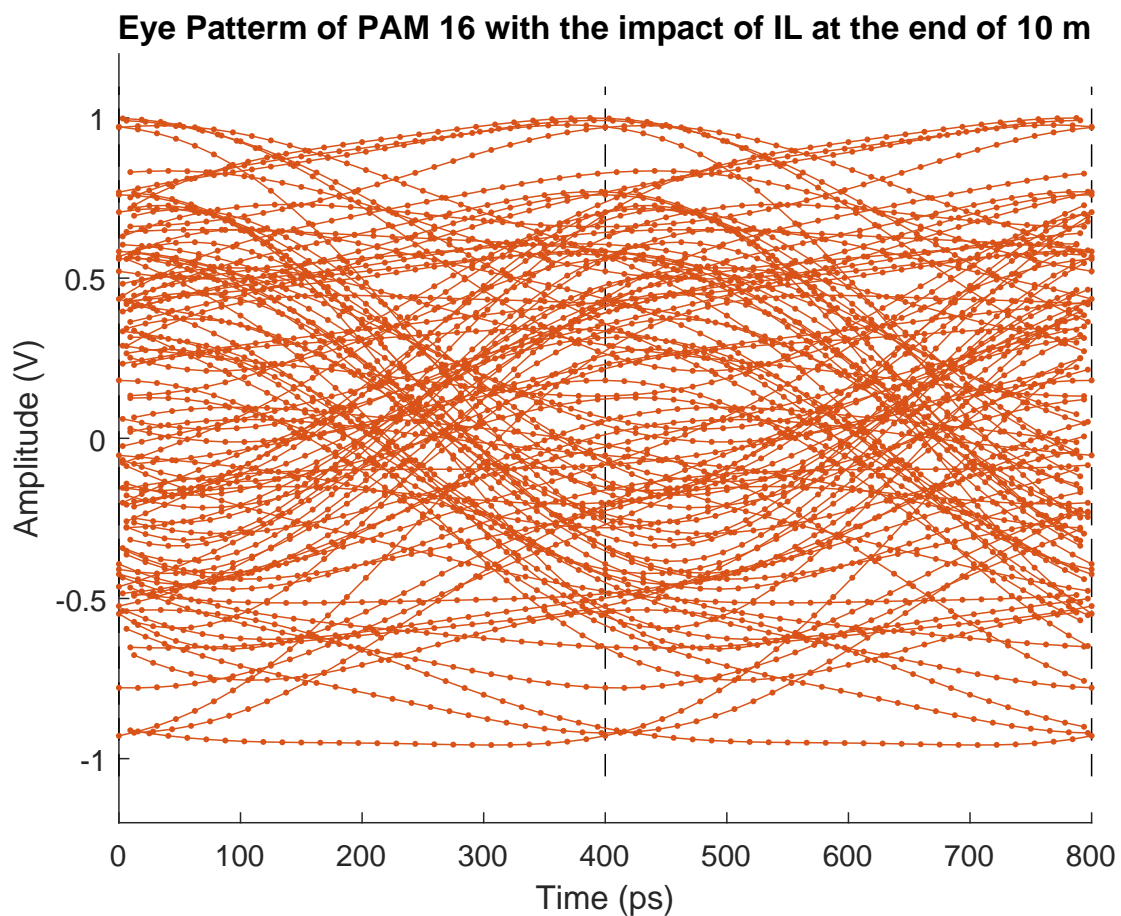

Figure 37 – Eye Pattern of PAM 16 (40 GBit/s), with impact of IL (10 m)

Figure 37 shows the simulated Eye Pattern of the signal sequence at the end of the Twisted Pair cable. The abscissa shows the time in picoseconds. The ordinate shows the voltage in volts.

Modulation and Simulation of Data Transmission

When looking at the corresponding Eye Pattern, it is noticeable that the eye openings are no longer open as in the original Eye Pattern in figure 34. Where the signals could be distinguished up to now can no longer be decided clearly for some signals to which decision level the symbol belongs. In other words, this simulation shows qualitatively that the transmission cannot be demodulated error-free, because the decision thresholds are not clear.

4.5 Comparison of Original and Simulated Signal at the End of the Cable

To illustrate these findings once again, a comparison is made between the simulation of the original signal and the attenuated signal.

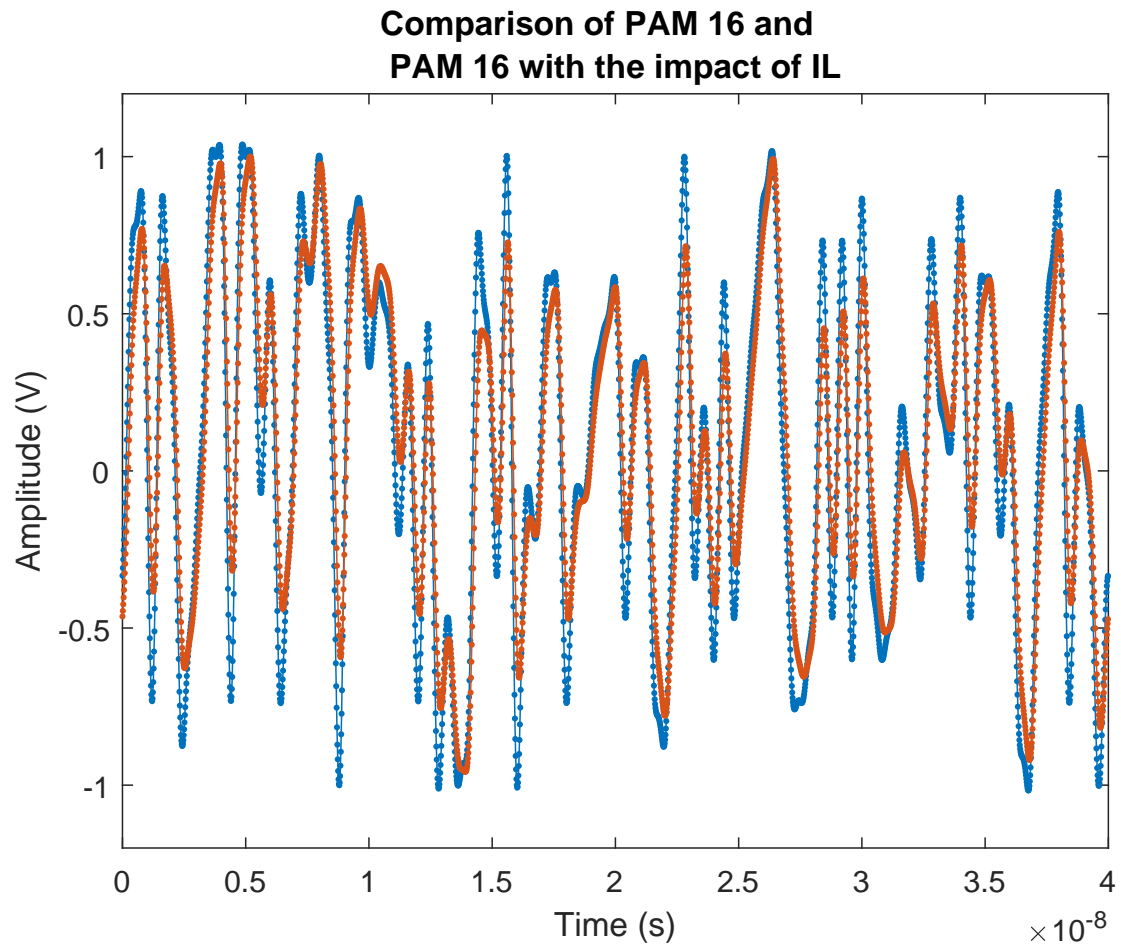

Figure 38 – 100 symbols of PAM 16 (40 GBit/s) and PAM 16 with impact of IL (10 m)

Figure 38 shows the temporal signal of the originally simulated signal sequence of the 100 symbols PAM 16 signal sequence in blue and the simulated attenuated signal sequence of the 100 symbols at the end of the 10 m long copper cable in red. The

abscissa with the time in seconds and the ordinate with the voltage in volts were retained in order to obtain comparability with the previous figure 31 and figure 35.

It is clearly visible that the red line is often smaller than the blue line. This occurs especially when the voltage change is very large. At these points higher frequency components are necessary. If the voltage changes are rather small, the red line corresponds better with the original blue line. Altogether the form of the time signal differs clearly.

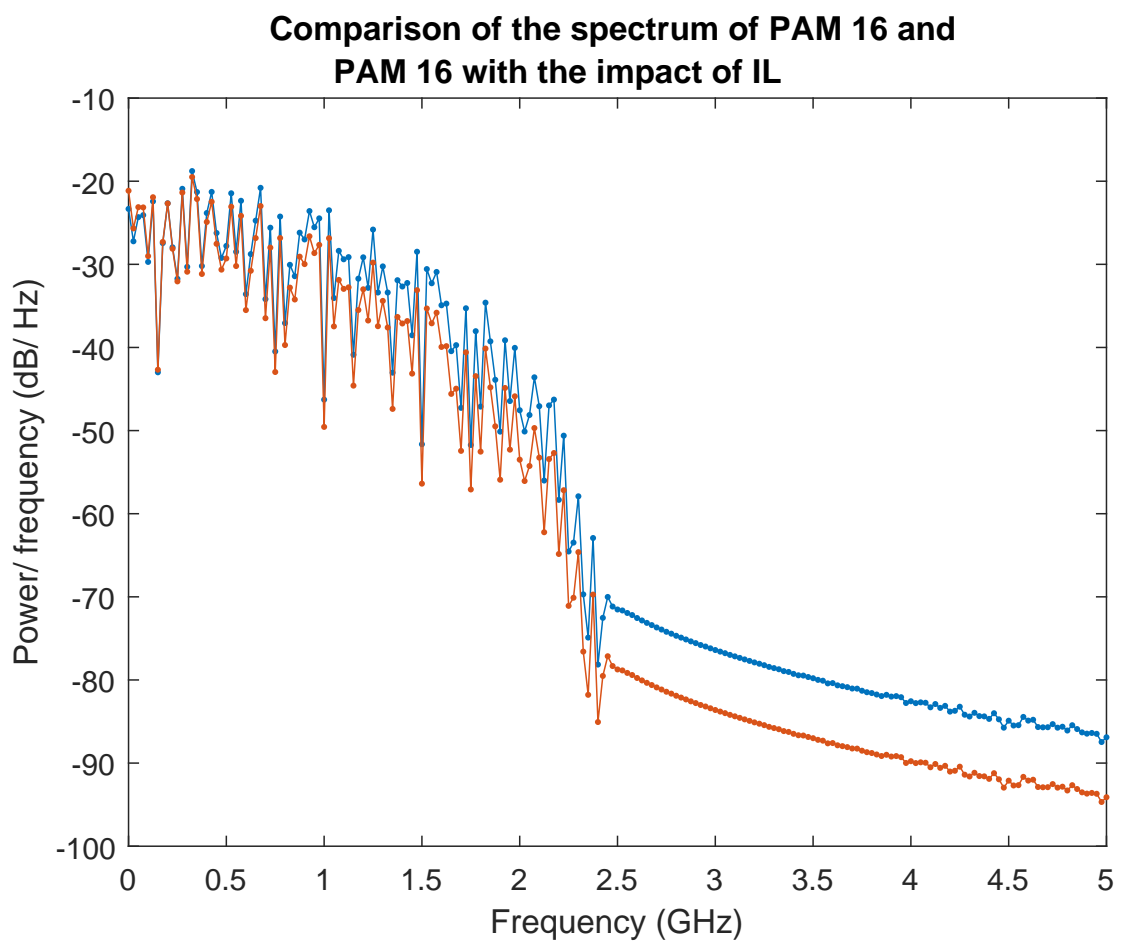

Figure 39 – Spectrum of PAM 16 (40 GBit/s), with impact of IL (10 m)

Modulation and Simulation of Data Transmission

This effect is also evident when comparing the spectra of figure 32 and figure 36. Again, the abscissa with frequency in GHz and ordinate with the relative power per frequency in dB/Hz, were retained. A closer look at figure 39 shows that the two lines match in the lower frequency range. The higher the frequency, the higher the difference between the two lines. This confirms the statement that the higher frequencies are attenuated more than the lower frequencies and that the signal shapes no longer match the original version.

4.6 Simulation of Pre-Emphasised Signal

The two previous simulations showed how much the Insertion Loss affects the data transmission. In order to counteract this unwanted attenuation of the cable, pre-emphasis is performed. For this purpose, the original time-domain signal of the symbol sequences is converted into a spectrum with a Fast Fourier Transformation. This spectrum is then multiplied by the inverse spectrum of the Insertion Loss measurement. This amplifies the higher frequency components, which are normally more attenuated. The smaller frequency components, which are normally greater than the attenuated high frequency components, are now reduced. The spectrum is then transformed back again so that a time signal is generated again.

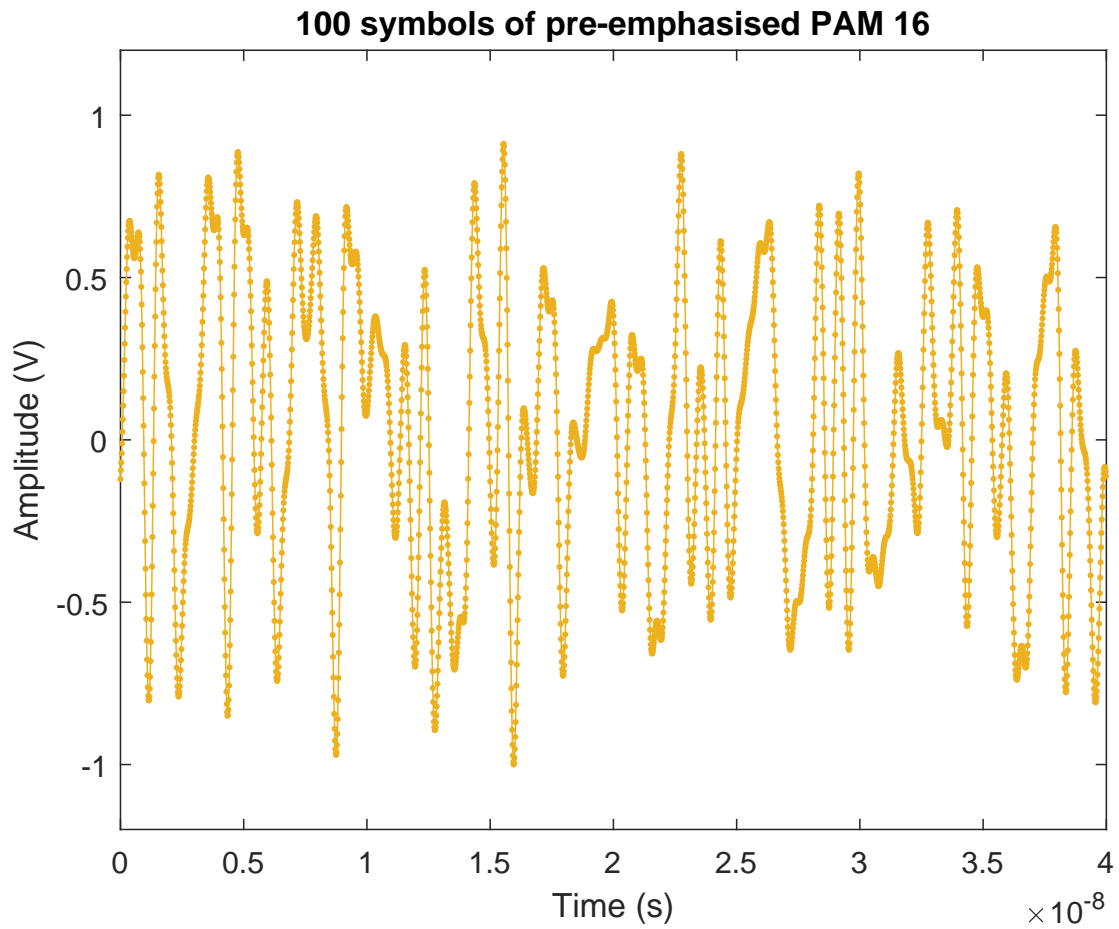

Figure 40 – Pre-emphasised 100 symbol of, PAM 16 (40 GBit/s) (10 m)

Figure 40 shows the simulated signal sequence with the pre-emphasis. The abscissa represents the time in seconds. The ordinate represents the voltage in volts. The maximum positive voltage is around 0.9 V. The minimum negative voltage is around -0.9 V. This already shows that the curve is smaller than the original curve in figure 31. Furthermore, a closer look reveals that the curve overshoots when there are large voltage changes. This effect is intended to counteract the attenuation of the cable at higher frequencies.

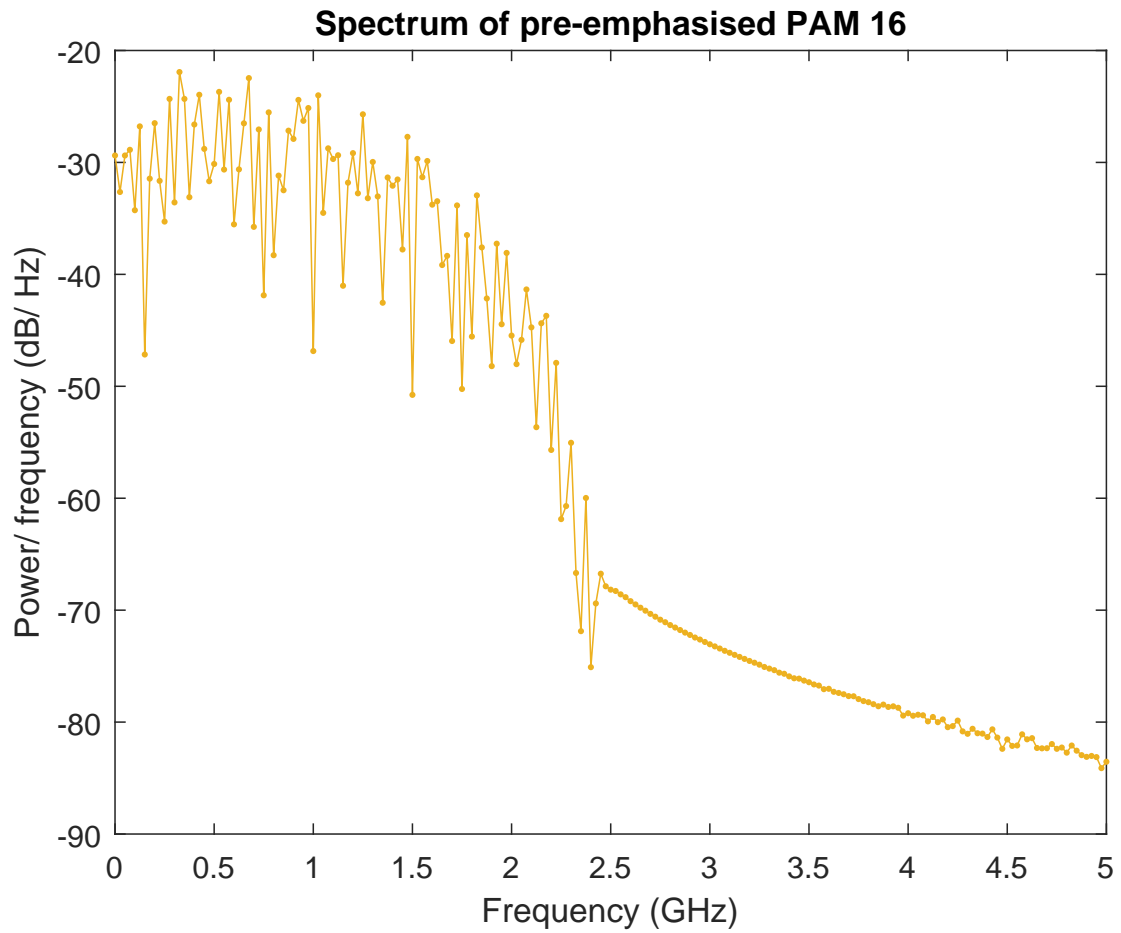

Figure 41 – Spectrum of pre-emphasised PAM 16 (40 GBit/s) (10 m)

Figure 41 shows the spectrum of the pre-emphasised signal sequence. The abscissa shows the frequency in GHz. The ordinate shows the relative power per frequency in dB/Hz. The spectrum shown also confirms the statements in Figure 41. The lower frequency components are smaller than in the original spectrum. The higher frequency components were amplified.

4.7 Simulation of Pre-Emphasised Signal at the End of the Cable

To test the quality and functionality of the pre-emphasised signal, the pre-emphasised signal is simulated at the end of the 10 m cable. A flattening is achieved by combining the pre-emphasized signal and the low-pass behaviour of the cable. With this method, a frequency response can be realized at the end of the 10 m long cable that corresponds to the original frequency response of the output signal sequence. However, the signal is now clearly attenuated overall and is therefore much smaller than the original signal.

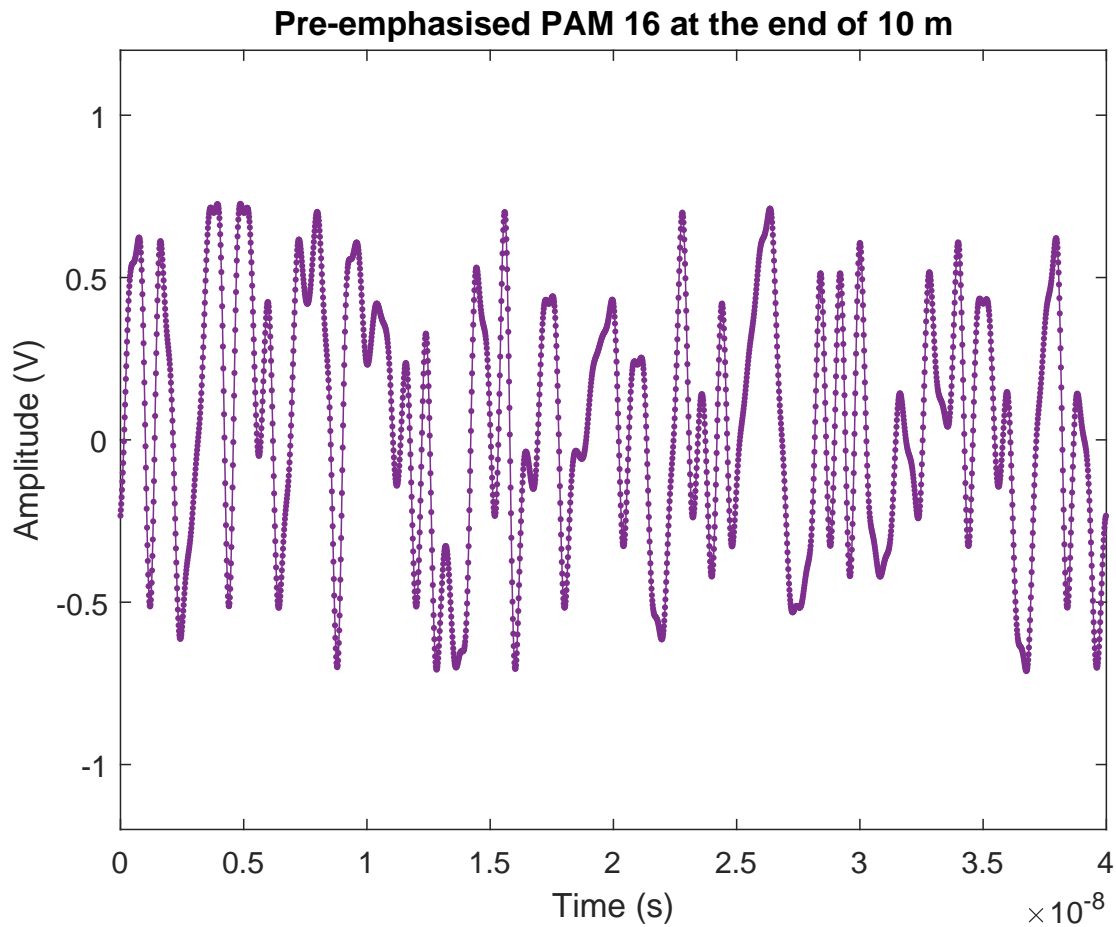

Figure 42 – Pre-emphasised 100 symbols of PAM 16 (40 GBit/s) (10 m, end)

Figure 42 shows the simulated signal sequence with the pre-emphasis at the end of the copper cable. A comparison of the pre-emphasised signal with the un-emphasised signal is presented in section 4.5.

The abscissa represents the time in seconds again and the ordinate represents the voltage in volts again. The maximum positive voltage is around 0.75 V. The minimum negative voltage is around -0.75 V. This already shows that the curve is much smaller than the original curve in figure 31. The figure 41 shows that the signal is now less "round" compared to the attenuated signal at the end of the 10 m long copper cable.

This is due to the fact that the frequency components are now the same again over the entire frequency bandwidth. The signal shape looks exactly like the original curve, only the amplitudes are smaller. This effect is caused by the pre-emphasis.

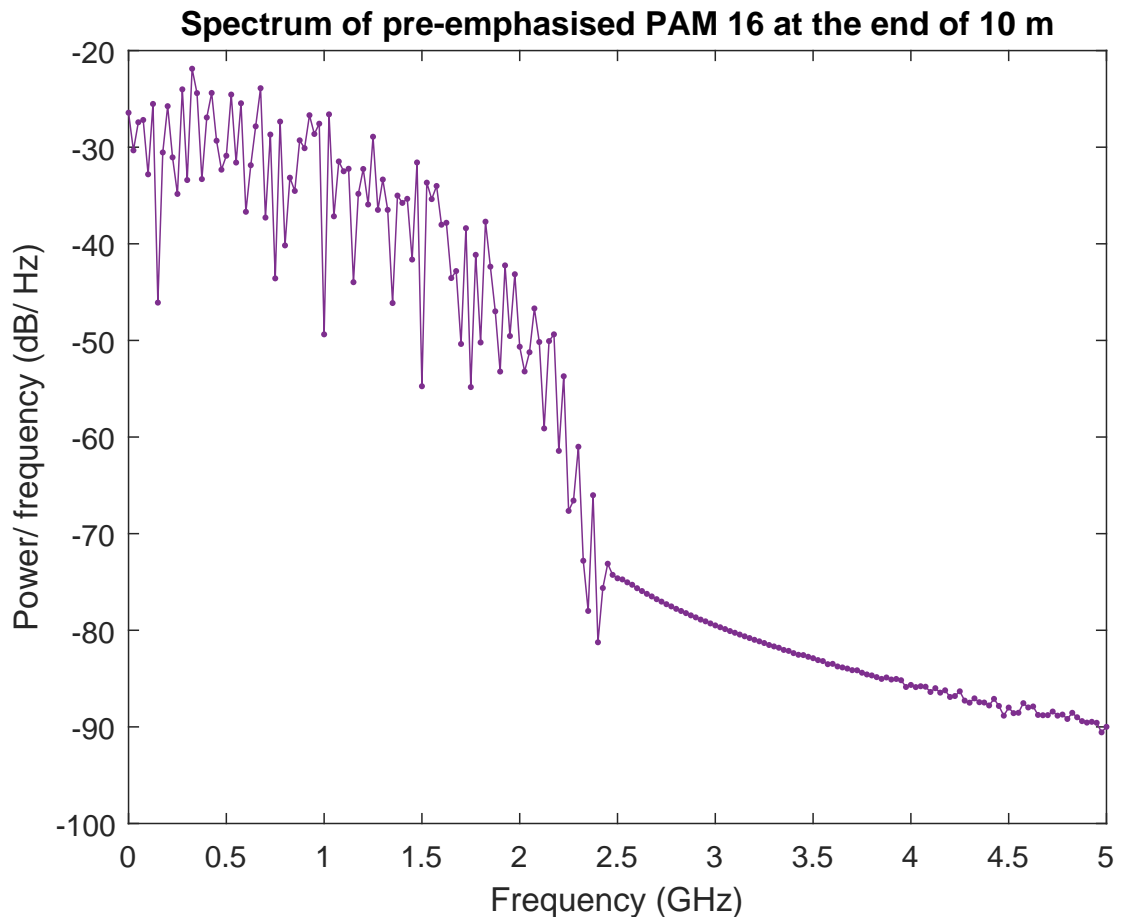

Figure 43 – Spectrum of pre-emphasised PAM 16 (40 GBit/s) (10 m, end)

Figure 43 shows the spectrum of the pre-emphasised signal sequence at the end of the Twisted Pair cable. The abscissa shows the frequency in GHz. The ordinate shows the relative power per frequency in dB/Hz. The spectrum shown also confirms the statements on Figure 43. Although the power components are lower overall, the ratio of the powers is more balanced.

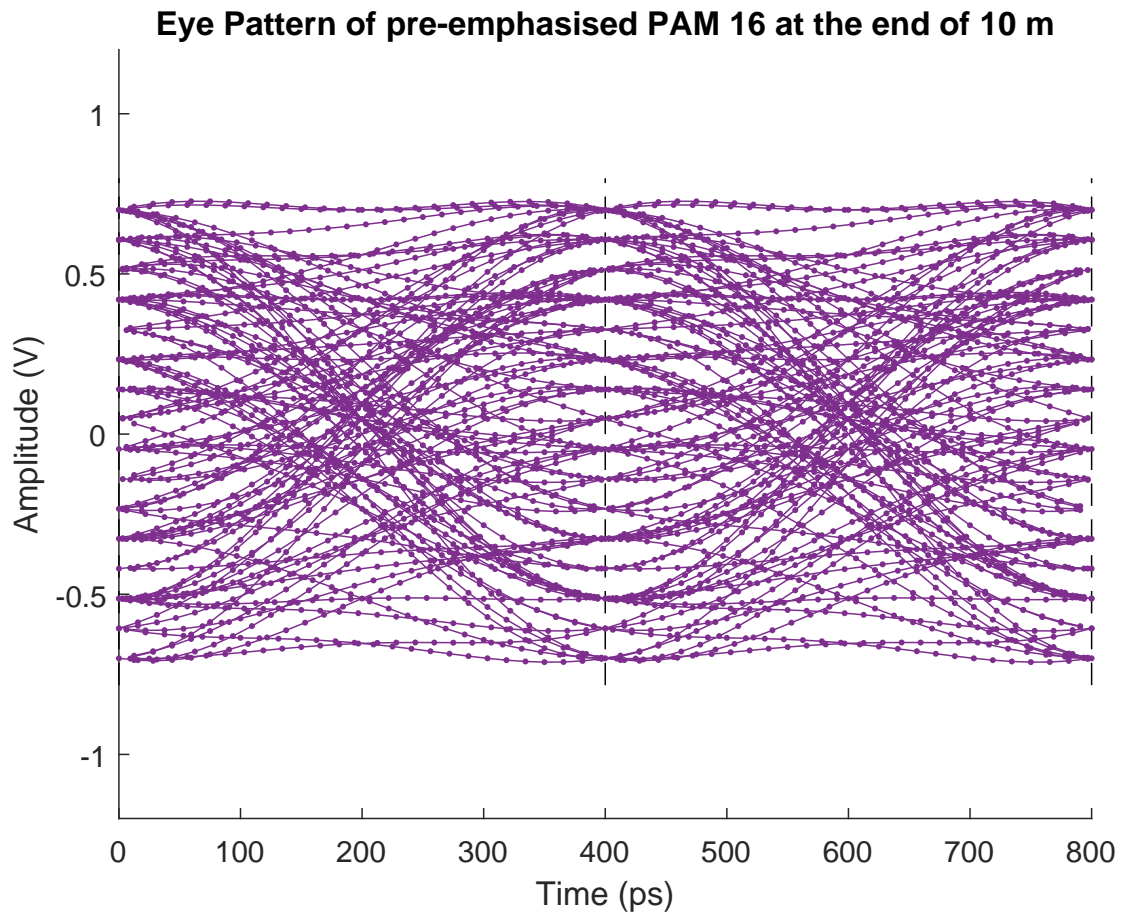

Figure 44 – Eye Pattern of pre-emphasised PAM 16 (40 GBit/s), (10 m, end)

Figure 44 shows the corresponding Eye Pattern of the pre-emphasised signal sequence at the end of the 10 m long copper cable. The abscissa is the time in picoseconds again. The ordinate is voltage in volts again.

The Eye Pattern now shows reopened eyes in the middle of the graph instead of the attenuated Eye Pattern without pre-emphasis. It should therefore be possible to demodulate the signal sequence without errors.

4.8 Comparison of Original and Simulated Signal with Pre-Emphasis

To show the result of the pre-emphasised signal even more clearly, a comparison of the original signal and the pre-emphasised signal is made at the end of the Twisted Pair cable.

Comparison of PAM 16 and pre-emphasised PAM 16 at the end of 10 m

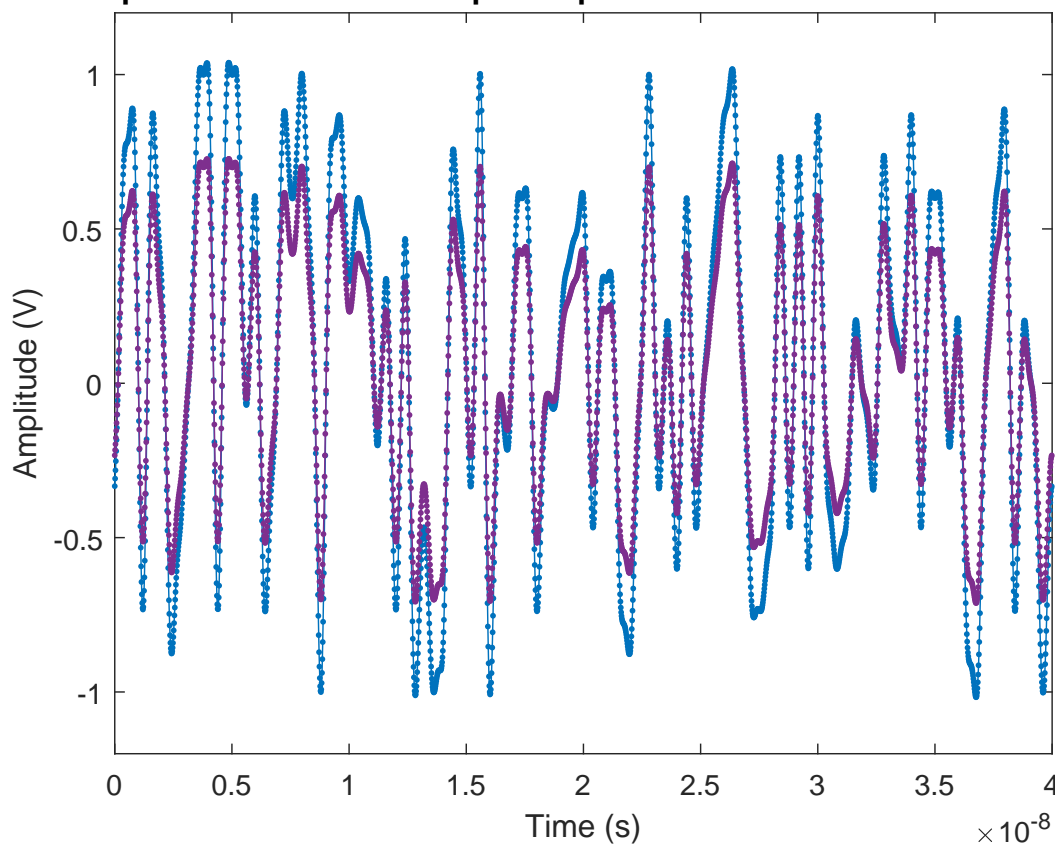

Figure 45 – 100 symbols of PAM 16 (40 GBit/s) and pre-emphasised PAM 16 (10 m, end)

For better comparability the abscissa represents the time in seconds and the ordinate the voltage in volts. The comparison of the original signal sequence in blue and the

now resulting pre-emphasised signal sequence at the end of the 10 m long cable in violet also shows that the course of the signal sequences now coincides better. Only the amplitude is reduced with the resulting signal sequence. The reduction of the amplitude is necessary for the pre-emphasis. As the higher frequencies are automatically attenuated by the cable, the lower frequencies must also be attenuated for the pre-emphasis. It should be noted, however, that the amplitude has been reduced evenly. This makes demodulation possible.

Comparison of the spectrum of PAM 16 and pre-emphasised PAM 16 at the end of 10 m

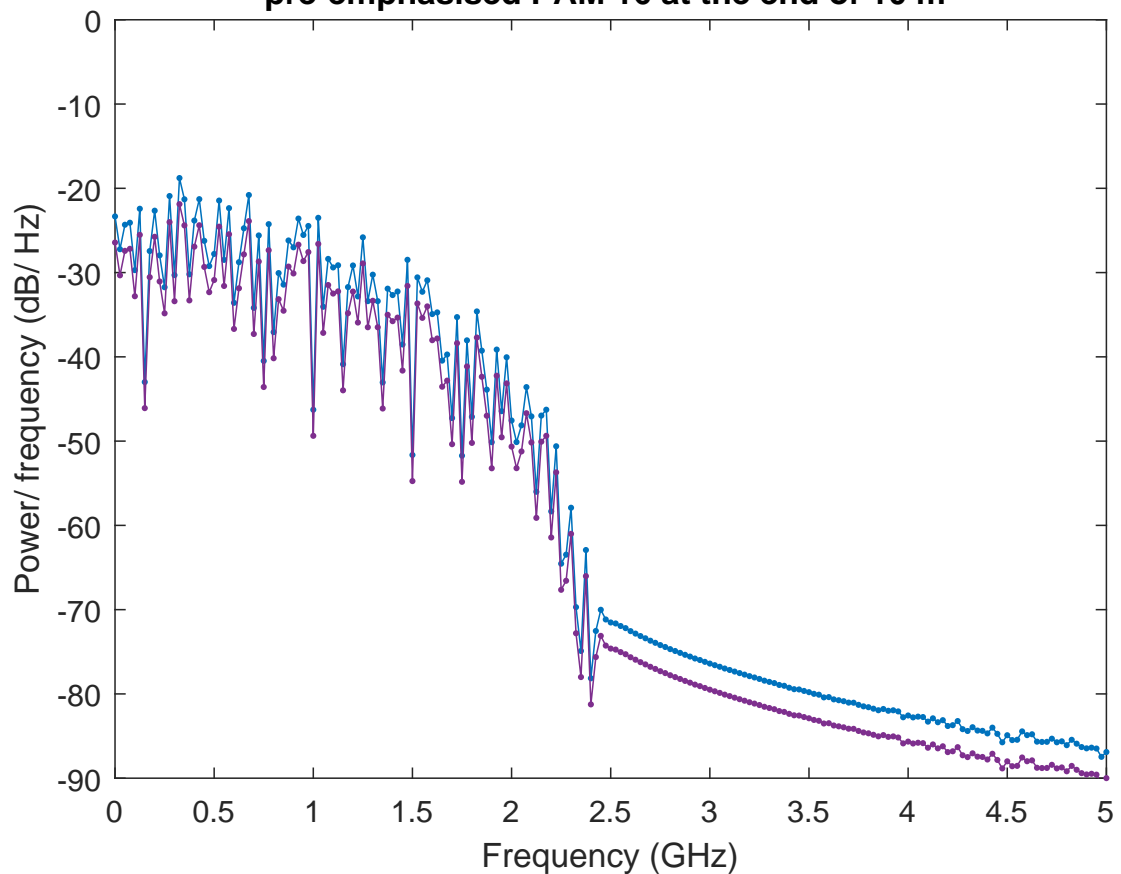

Figure 46 – Spectrum of PAM 16 (40 Gbit/s) and pre-emphasised spectrum (10 m, end)

Figure 46 shows the comparison of the spectrum of the originally signal sequences in blue and the pre-emphasised signal sequence at the end of the Twisted Pair cable in violet. The axes are the same, the abscissa represents the frequency in GHz and the ordinate represents the relative power per frequency in dB/Hz. The spectrum confirms the statements on Ffigure 42. Although the power components are lower overall, the ratio of the powers is perfectly balanced and the spectrum corresponds to the original spectrum apart from the strength.

4.9 Summary of Modulation and Simulation of Data Transmission

In this chapter the Pulse Amplitude Modulation and the Raised Cosine Filter were explained. Furthermore the Pseudo Random Sequence used for the signal sequence was introduced. This signal sequence ensures that all pair combinations are present on consecutive symbols. This is important for the later real transmission to guarantee all possibilities of transmission. This signal sequence was then used to simulate a theoretical transmission. During transmission, the Insertion Loss in particular is a limiting factor for the transmission. Based on this, a transmission was simulated which includes the low-pass behaviour of the cable. This corresponds to a transmission via the cable without pre-emphasis and thus illustrates the necessity of pre-emphasis in order to identify the different voltage values of the transmission.

Based on these findings, a pre-emphasized signal sequence was created to counteract the attenuation characteristics of the cable. The simulation of the pre-emphasized transmission is the core of this transmission and shows as a result the received signal which allows to identify the different voltage values. This pre-emphasized signal is used for the data transmission in the following chapter.

5 High Bit Data Transmission and Bit Error Rate Probability

This chapter deals with a higher bit-rate data transmission with Pulse Amplitude Modulation over different lengths of Twisted Pair cable with the aim of investigating the potential of shorter copper cables. Many applications require only short lengths to the end devices. A higher data rate can be achieved by shorter lengths and a lower Insertion Loss. However, previous standards have only been standardized to 30 or 100 m. Other lengths still have potential for higher data rates. Furthermore, a statement is made about the possible Bit Error Rate of the respective transmission. The calculated Bit Error Rate is created with the help of Eye Contours, a software for sampling oscilloscopes. This software provides a forecast of the bit error probability.

5.1 Bit Error Rate

The Bit Error Rate (BER) is a measure of data integrity. It is defined by the number of received error bits in relation to the total number of received bits. The Bit Error Rate is usually expressed as a negative power of ten [30, p. 452]. A Bit Error Rate of 10^{-12} corresponds to a bit error of one trillion received bits [30, p. 175]. In the standards of IEEE at least a BER of 10^{-12} or higher is expected [2, pp. 162-163].

$$\text{Data rate} = \frac{\text{Baud rate} \cdot \text{Number of bits}}{\text{symbol}} \quad (13)$$

High Bit Data Transmission and Bit Error Rate Probability

The Bit Error Rate depends on various factors. Bit errors are caused by noise, interference, distortion or bit synchronization errors [95, p. 46]. Noise especially plays a major role in the Bit Error Rate. If the signal to noise ratio is high, then the Bit Error Rate will be very small. If there is a lot of noise in the system the Bit Error Rate is high [96].

Noise usually has a random characteristic. For the simulation we assume that the noise has a Gaussian distribution. The Gaussian distribution for noise is a well-known and often used assumption. This leads to the fact that the points are no longer at an ideal point, but deviate. Many of these points are still very close to the ideal point. Other points are very far away from the ideal point. Not all of the deviating points result in a bit error. Only the points that exceed the threshold between two bits are decoded as bit errors [97].

Figure 47 shows such a distribution for two different bits. The abscissa represents the voltage. The blue curve shows the distribution for bit S1 and the red curve shows the distribution for bit S2. The coloured areas each show the misinterpreted bits and therefore bit errors [97].

High Bit Data Transmission and Bit Error Rate Probability

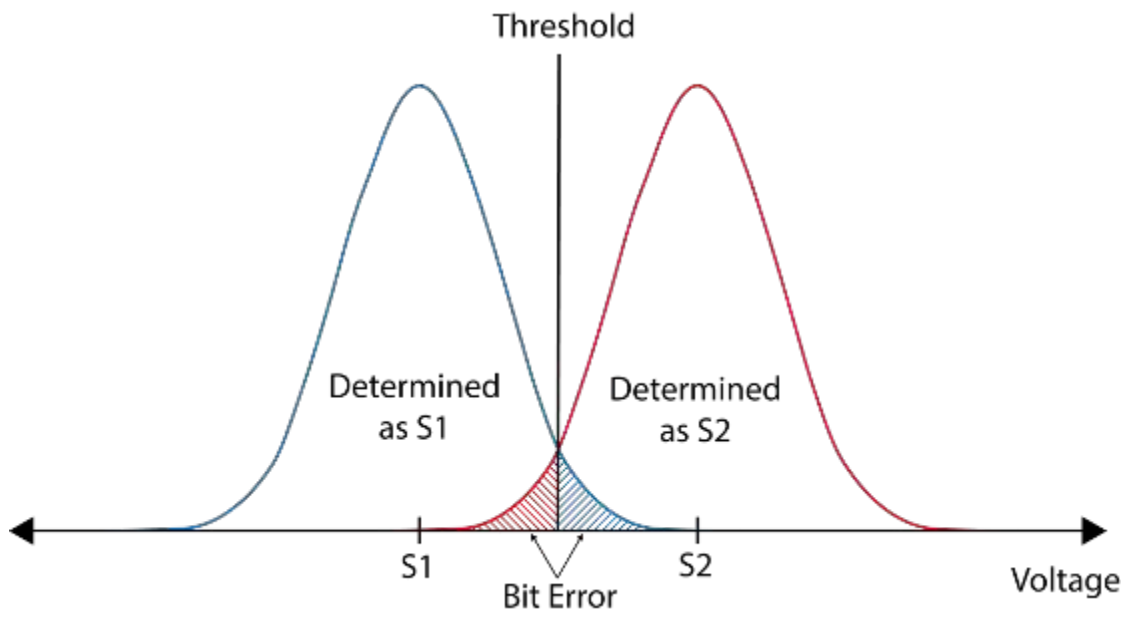

Figure 47 – Bit Error Rate [97]

5.2 Measurement Setup of High Bit Data Transmission

For the measurements of the high bit data transmission a pseudo statistical signal was sent on the device under test (DUT) in this case a 10, 30, 50, 75 and 100m long S/FTP cable. The test sequence with a pseudo statistical bit sequence is based on higher order Pulse Amplitude Modulation. A total of three different PAM encodings were tested, PAM 8 (3 bits per symbol), PAM 16 (4 bits per symbol) and PAM 32 (5 bits per symbol).

Due to the measurement possibilities in the laboratory, only one pair of the four wire pairs was examined in this thesis. When selecting the pair, care was taken to examine the pair with the greatest Insertion Loss, as this is the greatest limitation in the following measurements.

For example, for a 100 GBit/s transmission over four pairs, a 25 GBit/s transmission over one pair was analysed. The investigation of the cable prototype has shown that NEXT exceeds -65 dB and FEXT exceeds -80 dB. The attenuation of the prototype cable with a bandwidth of 3 GHz is only -30 dB at a length of 30 m. For a line coding with a Pulse Amplitude Modulation with 32 steps, the required signal-to-noise ratio is 30 dB. The resulting influence of NEXT and FEXT is thus so small that it was not taken into account in further investigations.

The test setup of the data transmission includes an arbitrary waveform generator (AWG M8195A from Keysight [98]), which generates the bit sequences, here pseudo-statistical sequences, and a sampling oscilloscope (DCA-X 86100D from Keysight [99]), which outputs the received signals, which were then demodulated and analysed.

High Bit Data Transmission and Bit Error Rate Probability

Figure 48 shows the described measurement setup for all high bit data transmissions and Bit Error Rate probabilities (see section 8.2.2).

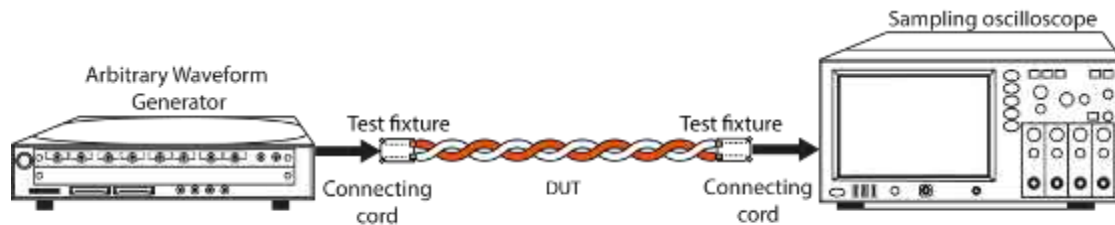

Figure 48 – Measurement setup for data transmission and Eye Pattern diagrams

The Arbitrary Waveform Generator sends the desired transmit signal. For this purpose the Pulse Amplitude Modulation (here PAM 8, PAM 16 or PAM 32) and the desired baud rate must be selected on the measuring instrument. In addition, the pre-emphasis is selected. Therefore the Insertion Loss of the cable has been loaded into the program of the AWG.

An in-system calibration was used for the following measurements. For this purpose, the AWG is connected directly to the oscilloscope via a connecting cord. The AWG then sends a specific signal sequence and automatically receives the received signal from the oscilloscope. The AWG compares the transmitted signal with the received signal from the oscilloscope. Based on this comparison and an automated routine correction, the AWG itself corrects its output signal. In addition to this correction, the spectral measurements of the Insertion Loss of the prototype cable are read into the software of the arbitrary waveform generator. The inverted value of the Insertion Loss and the spectrum of the desired signal are multiplied to result in the pre-emphasis spectrum of the signal. This is again converted into the time signal. The result of this calculation is a corrected waveform.

High Bit Data Transmission and Bit Error Rate Probability

The received baud rate and the time period are set on the oscilloscope. Depending on which measurement is desired, either the eye diagram or oscilloscope option must be selected on the oscilloscope. With the option eye diagram the Eye Pattern of a signal sequence is displayed. With the option oscilloscope the whole signal sequence is displayed.

The aim of these measurements was to find out what maximum possible bit rates can be realized over which length. In addition, the aim was to find out which encoding method should be used for the transmission of maximum bit rates over the respective lengths of symmetrical copper cables.

The term data length product is mostly used in context of fibre optic cables. However, the term can also be applied to copper cables. It refers to the product of bandwidth and the associated data rate of the transmission and the length of the cable. The Bit Error Rate plays a key role here. The higher the data rate and the longer the copper cable the higher the probability of bit errors [100].

5.3 Bit Error Rate Probability

In order to obtain a statement about the transmissions, Eye Patterns of the transmissions were created. Eye diagrams are a means of making an analysis and a statement about the data transmission and the associated signal interference of data transmissions [101, p.52, 102, p. 294]. An eye diagram is created by overlapping samples of each individual symbol [103, pp. 24-26, 72, pp. 24-26]. In an ideal transmission an eye diagram would look like a stack of rectangular boxes. In a real transmission, the transitions are not perfectly overlaid, due to variations in amplitude, jitter and other timing issues, external noise, etc., resulting in an eye-shaped pattern [104]. This applies to binary transmission. In a higher-value line coding, such as PAM 4, the eye diagram has several openings [105, pp. 1-7, 106, pp. 21-22]. When modulating PAM 4, it has three openings.

In general, the more the eye is open, the greater the probability that the symbol can be demodulated correctly. Conversely, the more disturbances affect the transmission, the smaller the eye becomes. The eye diagram cannot be used to indicate protocol or logic errors [107, p. 301]. However, it is a useful tool to detect visual impairments of the received signal in terms of amplitude and time distortion and to make a statement about the quality of the transmission [108, 109, pp. 127-128].

Today's bit error testers can analyse a PAM modulation up to 4 levels. However, since higher order PAM modulations were used in this thesis, no bit error tester could be used for this analysis. Instead of a bit error tester, the bit error probability was determined using Keysight's Eye Contours analysis software.

The Eye Contours software was originally developed for DDR4. DDR4 stands for Double Data Rate 4 and is a memory integrated circuit. The Eye Contours software analyses Eye Patterns to predict the bit error probability. To enable this, the software

High Bit Data Transmission and Bit Error Rate Probability

extrapolates noise and jitter trends of the measured signal. These measured noise and jitter values can be used to predict how the eye will close over time. Then the eye contours and thus the bit error probability can be calculated [110]. The exact calculation formula of the Eye Contours software is a Keysight trade secret. Figure 49 shows an example of an Eye Pattern measurement with a transmission of 40 GBit/s over 10 m copper cable and a PAM 16 coding.

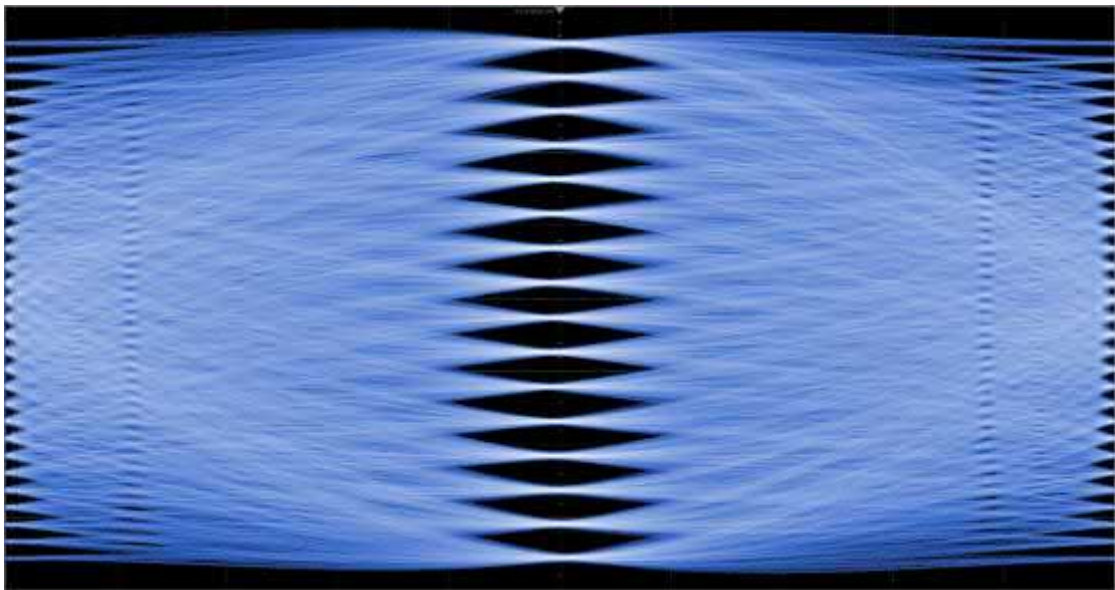

Figure 49 – Eye Pattern PAM 16 (40 GBit/s), 10 m, abscissa: 40 ps/div - ordinate: 120 mV

Figure 49 shows that the eyes are open: there is clear space with no blue lines passing through. The 15 eyes of the PAM 16 coding are all clearly recognizable. In order to make a statement about the bit error probability of this transmission, these 15 eyes are now divided into smaller image sections to analyse 3 eyes each. These 5 images with 3 eyes each are shown in figure 50 - figure 54.

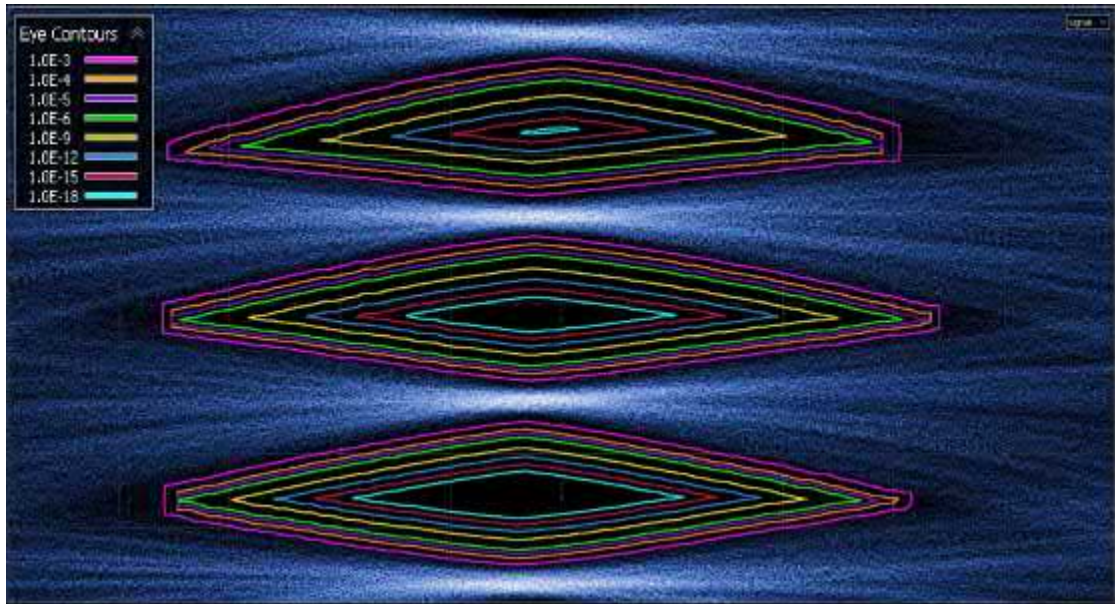

Figure 50 – Eye Pattern of the eyes [1-3] of PAM 16 (40 GBit/s), 10 m

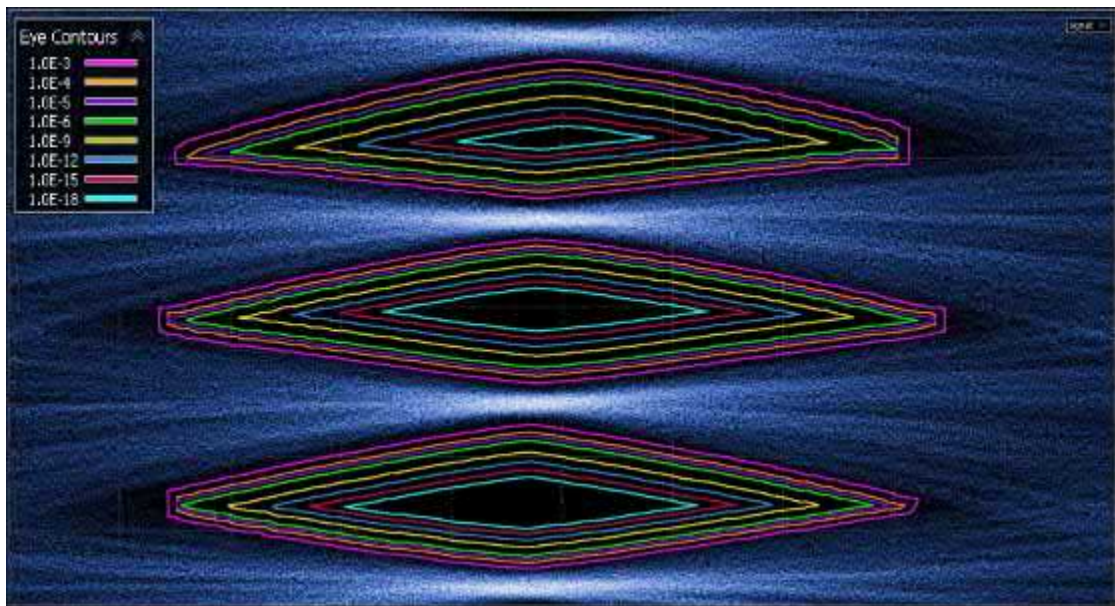

Figure 51 – Eye Pattern of the eyes [4-6] of PAM 16 (40 GBit/s), 10 m

High Bit Data Transmission and Bit Error Rate Probability

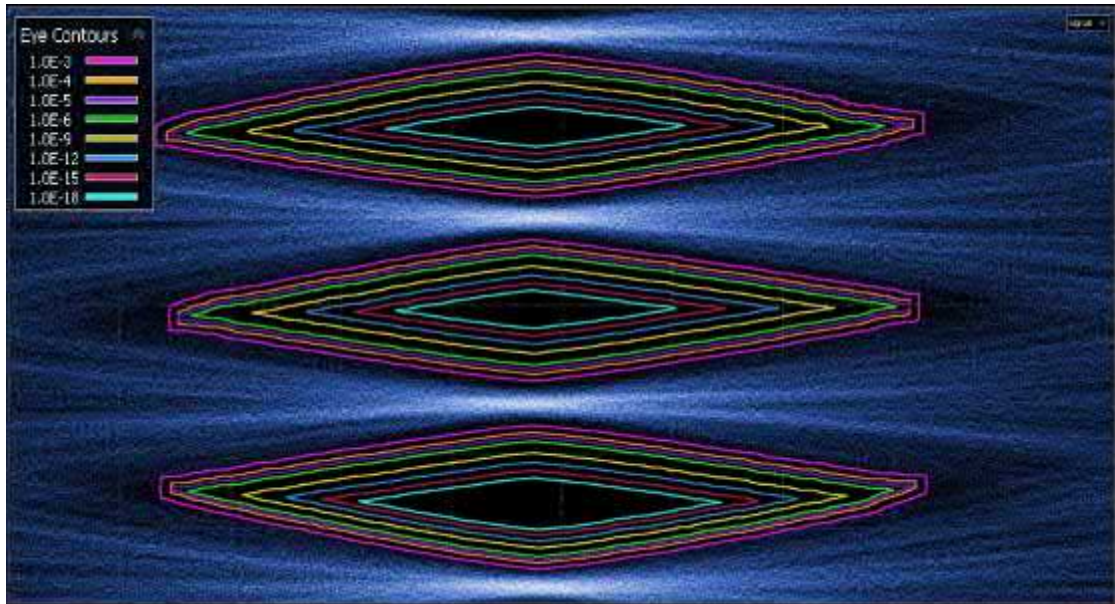

Figure 52 – Eye Pattern of the eyes [7-9] of PAM 16 (40 GBit/s), 10 m

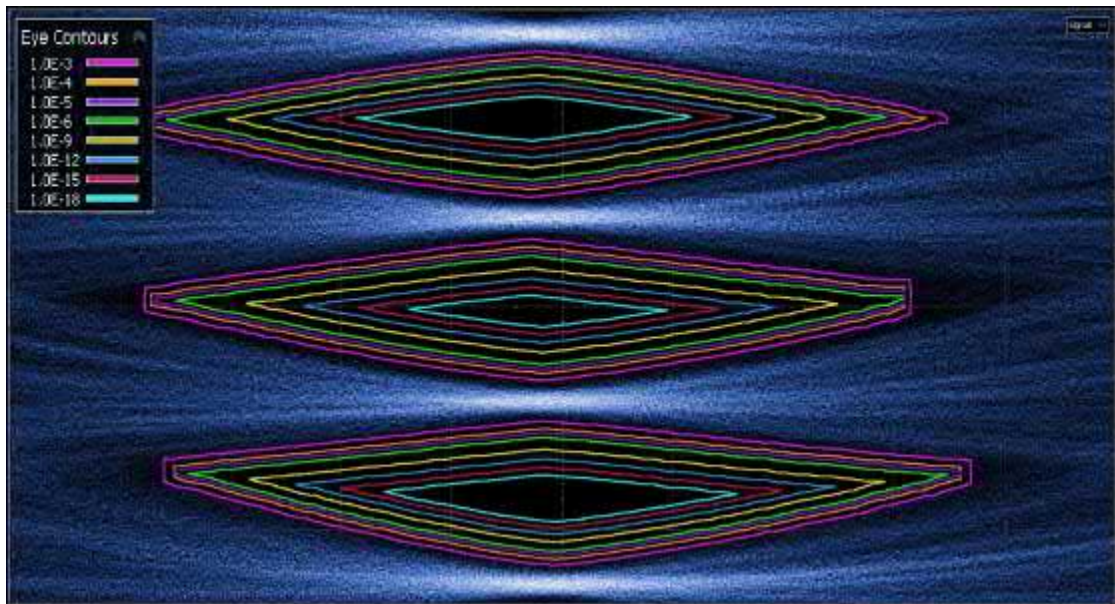

Figure 53 – Eye Pattern of the eyes [10-12] of PAM 16 (40 GBit/s), 10 m

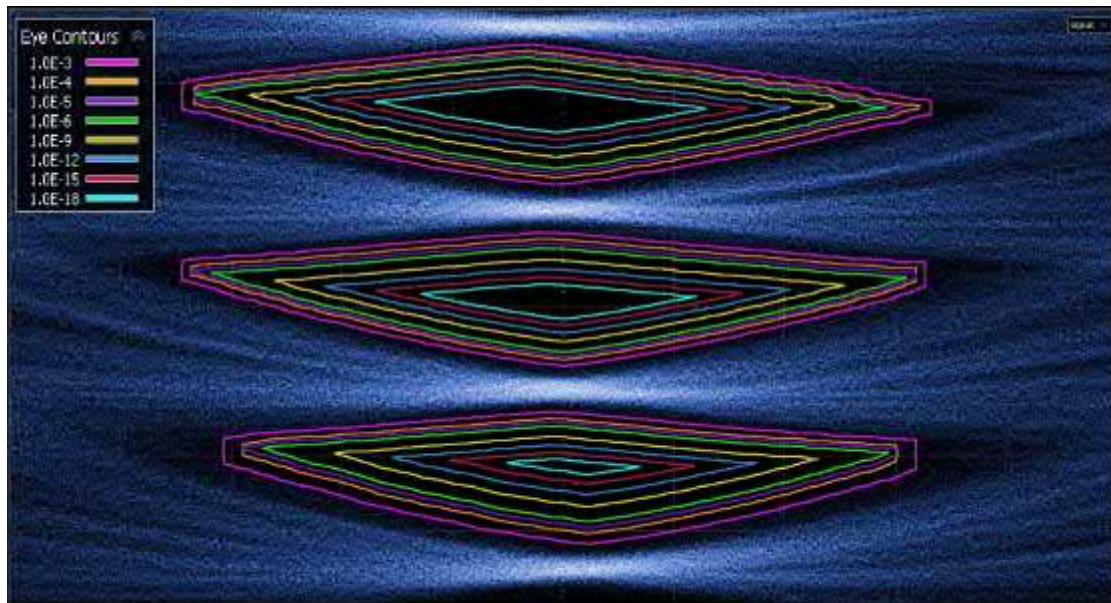

Figure 54 – Eye Pattern of the eyes [13-15] of PAM 16 (40 GBit/s), 10 m

Figures 50 to 54 show part of a close-up of fig. 49. Each figure shows 3 eyes of a total of 15 eyes of the PAM 16 transmission. The displayed lines inside the eye openings are calculated by the Eye Contours software of Keysight. The lines give information about the probability of the Bit Error Rate. The lines inside the eye have the following bit error probabilities (from outside to inside): pink 10^{-3} , orange 10^{-4} , purple 10^{-5} , green 10^{-6} , yellow 10^{-9} , blue 10^{-12} , red 10^{-15} , turquoise 10^{-18} .

Here it can be seen that all 15 eye openings of the 5 images also have the turquoise line as their innermost line. This line means a Bit Error Rate probability of 10^{-18} . In order to make a statement about the total transmission, the Bit Error Rate probabilities of all eyes must be calculated together and must be averaged. This average can then be assumed as a prediction of the bit error probability for the transmission of this higher order pulse amplitude modulated signal. This is based on the assumption that each stage occurs the same number of times and therefore each eye opening has the same importance for the Bit Error Rate. Furthermore a Grey coding is used. This

High Bit Data Transmission and Bit Error Rate Probability

means that each neighbouring bit sequence only differs in one bit. The Hamming distance for neighbouring bit sequences is therefore one.

These measurements were made for five different cable lengths (10, 30, 50, 75, 100 m). These cable lengths were measured in 2.5 GBit/s steps from 2.5 GBit/s to 25 GBit/s for one pair of a four pair copper cables. For a four pair copper cable, this results in a data rate of 10 GBit/s to 100 GBit/s. This results in a total of 150 measurements. The results of these measurements have been summarized in Tables 6 to 10. Tables 6 to 10 show the BER probability of the respective data transmission. In the standards of IEEE at least a BER of 10^{-12} or higher is expected [2, pp. 162-163]. The cases that reach these values are highlighted in green in the tables. It can be seen that this minimum requirement is only achieved up to a length of 75 m. In addition, it can be seen that this requirement is not met by PAM 32 at any length. This minimum requirement is most frequently met by PAM 8.

Table 6 – BER probability of a data transmission of 10 m

Coding \ Data rate	GBit/s									
	10	20	30	40	50	60	70	80	90	100
PAM 8	1.00*e ⁻¹⁸	1.00*e ⁻¹⁸	1.00*e ⁻¹⁸	1.00*e ⁻¹⁸	1.00*e ⁻¹⁸	1.00*e ⁻¹⁸	1.00*e ⁻¹⁸	1.00*e ⁻¹⁸	1.00*e ⁻¹⁸	1.43e ⁻⁰⁷
PAM 16	1.00*e ⁻¹⁸	6.67e ⁻¹⁴	6.67e ⁻¹⁴	6.67e ⁻¹⁴	6.67e ⁻¹⁴	6.67e ⁻¹⁴	6.67e ⁻¹⁴	1.34e ⁻¹³	1.34e ⁻¹⁰	9.07e ⁻⁰⁶
PAM 32	9.76e ⁻⁰⁸	9.72e ⁻⁰⁸	6.46e ⁻⁰⁸	6.46e ⁻⁰⁸	6.46e ⁻⁰⁸	3.23e ⁻⁰⁷	7.16e ⁻⁰⁶	1.67e ⁻⁰⁵	3.57e ⁻⁰⁴	3.31e ⁻⁰⁴

High Bit Data Transmission and Bit Error Rate Probability

Table 7 – BER probability of a data transmission of 30 m

Coding \ Data rate	Gbit/s									
	10	20	30	40	50	60	70	80	90	100
PAM 8	1.00×10^{-18}	1.00×10^{-18}	1.00×10^{-18}	1.44×10^{-16}	4.29×10^{-16}	1.00×10^{-06}	1.00×10^{-04}	3.57×10^{-04}	2.86×10^{-01}	-
PAM 16	1.00×10^{-18}	2.00×10^{-16}	6.69×10^{-14}	2.67×10^{-14}	2.92×10^{-05}	2.80×10^{-04}	8.20×10^{-04}	1.00×10^{-03}	1.00×10^{-03}	6.70×10^{-01}
PAM 32	5.16×10^{-07}	1.67×10^{-05}	1.69×10^{-04}	5.16×10^{-04}	8.55×10^{-04}	1.00×10^{-03}	1.00×10^{-03}	1.94×10^{-01}	-	-

Table 8 – BER probability of a data transmission of 50 m

Coding \ Data rate	Gbit/s									
	10	20	30	40	50	60	70	80	90	100
PAM 8	1.00×10^{-18}	4.29×10^{-13}	8.57×10^{-07}	7.43×10^{-04}	-	-	-	-	-	-
PAM 16	6.67×10^{-11}	8.67×10^{-06}	1.00×10^{-04}	1.00×10^{-03}	4.00×10^{-01}	-	-	-	-	-
PAM 32	-	-	-	-	-	-	-	-	-	-

Table 9 – BER probability of a data transmission of 75 m

Coding \ Data rate	Gbit/s									
	10	20	30	40	50	60	70	80	90	100
PAM 8	8.57×10^{-13}	2.29×10^{-04}	-	-	-	-	-	-	-	-
PAM 16	-	-	-	-	-	-	-	-	-	-
PAM 32	-	-	-	-	-	-	-	-	-	-

High Bit Data Transmission and Bit Error Rate Probability

Table 10 – BER probability of a data transmission of 100 m

Coding \ Data rate	Gbit/s									
	10	20	30	40	50	60	70	80	90	100
PAM 8	1.00*e ⁻⁰⁴	-	-	-	-	-	-	-	-	-
PAM 16	-	-	-	-	-	-	-	-	-	-
PAM 32	-	-	-	-	-	-	-	-	-	-

This is due to the eye opening of the respective coding. With a PAM 32 coding, the eye openings are a quarter smaller than with a PAM 8 coding. This makes the demodulation of the received data more difficult. Due to the dynamics of the measuring station, the results are not directly comparable with the Ethernet applications, i.e. at 100 m and 10 Gbit/s, instead of the expected BER of 10^{-12} of the standard, it is only 10^{-4} .

Considering the minimum requirement of a BER of at least 10^{-12} or better, the following maximum bit rates can be realized.

With a 75 m long copper cable it can be realize a bit rate of 10 Gbit/s over a four pair copper cable with PAM 8. A 50 m long cable can realize a bit rate of 20 Gbit/s with a PAM 8 coding. For 30 m, a data rate of 50 Gbit/s can be transmitted via PAM 8. Due to the low attenuation of a 10 m long copper cable, the highest data rate of up to 90 Gbit/s can be achieved with this length.

5.4 Experimental Summary of High Bit Data Transmission

This chapter documents the practical tests of data transmission and the associated Bit Error Rates. The aim was to investigate the potential of shorter copper cables. Many applications in offices or data centres require only short cable lengths. However, previous standards only take lengths of 30 or 100 m into account. While shorter lengths or lengths between 30 and 100 m are not taken into account.

To investigate this in more detail, measurements of data transmission and Bit Error Rates were carried out on five different lengths (10, 30, 50, 75, 100 m). For each cable length, ten transmissions from 10 GBit/s to 100 GBit/s were performed. In addition, three PAM encodings were tested for each of the transmissions. Due to the large number of measurements, a very accurate estimation can be made, which length can reach which data rates and which PAM coding is useful for which transmission.

Current bit error testers can analyse only up to a PAM 4 coding. Higher order PAM cannot yet be tested for bit errors with bit error testers. In this thesis, the higher order PAM were checked for bit errors with Eye Patterns. Thus a bit error probability for PAM 8, 16 and 32 can be calculated. The results of this large number of measurements show that there is potential both for higher order PAM modulations and for new standards in different cable lengths.

A comparison of the three different PAM modulations shows that the highest data rates can be achieved with PAM 8 for all five cable lengths. This is due to the limitation of the AWG output. The AWG is limited to a maximum amplitude of 2 V peak to peak.

High Bit Data Transmission and Bit Error Rate Probability

This limits the output signal. If higher output voltages could be transmitted, larger distances between the levels would reduce the probability of bit errors.

When investigating the different cable lengths, the minimum requirements for bit error probability specified in the Ethernet standards were taken into account. This minimum requirement requires a bit error probability of at least 10^{-12} . Taking this minimum requirement into account, the following possible speeds result:

- for 75 m 10 GBit/s
- for 50 m 20 GBit/s
- for 30 m 50 GBit/s
- for 10 m 90 GBit/s.

All in all, there is also great potential for copper cables in the future. Especially for shorter cable lengths, such as 10, 30 or 50 m, significantly higher data rates can be achieved. This is of great interest especially for applications in data centres or for the last few meters, since often only short distances have to be laid here. Another important advantage of copper cables is their ability to transmit energy as well as data.

6 Transmission Performance in Relation to Higher Temperatures

This part of the thesis investigates the effect of installation applications. Beside data transmission, one of the most attractive installation applications for copper cable is Power over Ethernet. The demand for data throughput and energy supply are increasing in application such as sports stadiums. Depending on the amount of energy supply the temperature of the cables rises also. Due to this higher operating temperature the research issue arises: how will the spectral behaviour of the transmission of such cables change with higher temperatures.

6.1 Background and Present State of Scientific Knowledge

The temperature in the cables can increase significantly where there is a simultaneous supply for devices with data and energy (Power over Ethernet). Since the requirements in this area also increase from 15 or 30 W to 100 W in the future, the heating of the data cables may also increase significantly, and this needs to be considered as part of the design evolution of these cables.

The self-heating of the data cables adds to the environmental conditions. Data cables have different application areas and thus also different environmental temperatures.

Transmission Performance in Relation to Higher Temperatures

If data cables are laid within offices, they usually have an environmental temperature between 20 °C and 25 °C. However, if the data cables are bundled in cable ducts, under the floor, in the wall or on the ceiling, the temperature can be both cooler and significantly warmer than the typical room temperature. An example of this is a cable duct behind a glass wall of a high-rise building in direct sunlight or in production sites along blast furnaces.

Data cables are specified up to a temperature of maximum 60 °C. The transmission characteristics above a temperature of 60 °C are not well understood. If the data cable is operated at an environmental temperature above this and there is to be an additional power supply, the operating temperature of the data cables may rise above the permissible 60 °C. For this reason, the transmission characteristics at elevated temperatures are of particular interest.

In order to understand the potential problems, the effects of heating need to be investigated. Increasing the current the operation temperature of the data cables increases, too. The higher temperature leads to an influence on the data transmission characteristics of the data cable.

The data cables used in this thesis have a guaranteed long-term operating temperature of 60 °C. The use of data cables above this operating temperature is not standardized and not generally reported in the open literature. The cables are not approved for permanent operation at higher temperatures. Aging characteristics of the cable due to the temperature increase are therefore not the subject of this investigation but have been considered in the publication "Assessment of Bundle Heating due to Power Transmission over Ethernet cabling" [111]. The international technical specification ISO/ IEC TS29125 [112] describes the application of remote power up to 1000 mA per Twisted Pair. This technical specification considers the temperature increase of different cable constructions. However, the effects of data

Transmission Performance in Relation to Higher Temperatures

transmission characteristics of conventional data cables are not considered. Data cables are approved for a maximum operating temperature of 60 °C according to international standard ISO/ IEC 61156-9 [27] and ISO/ IEC 61156-10 [28], as well as in the European Norm DIN EN 50288 [29]. If the requirements of a simultaneous supply of data and energy increase, the operating temperature of the cables increases at the same time [113, pp. 60-66, 114, p. 11].

6.2 Experiment Setup and Measurements

As already mentioned in section 6.1, data cables are only approved up to an operating temperature of 60 °C and the effects on data transmission are only researched up to a temperature of 60 °C.

This chapter examines the effects on the spectral properties of a copper cable at higher temperatures. In previous research work on temperature increases and PoE, a copper cable is heated by an indexed current and the respective temperature increase is measured [111, 115].

In this new designed experiment, the cable is heated to the desired ambient temperature by a heating cabinet. The spectral properties, including Insertion Loss, Return Loss, Near End Crosstalk and Far End Crosstalk, are measured with a network analyser. The aim of this measurement setup is to determine the effects on the spectral properties of the cable at higher operating temperatures. Because the increase in temperature of the copper cable and the effects on the cable are of particular interest, the connecting cord leading to the network analyser is laid outside the heating cabinet.

Transmission Performance in Relation to Higher Temperatures

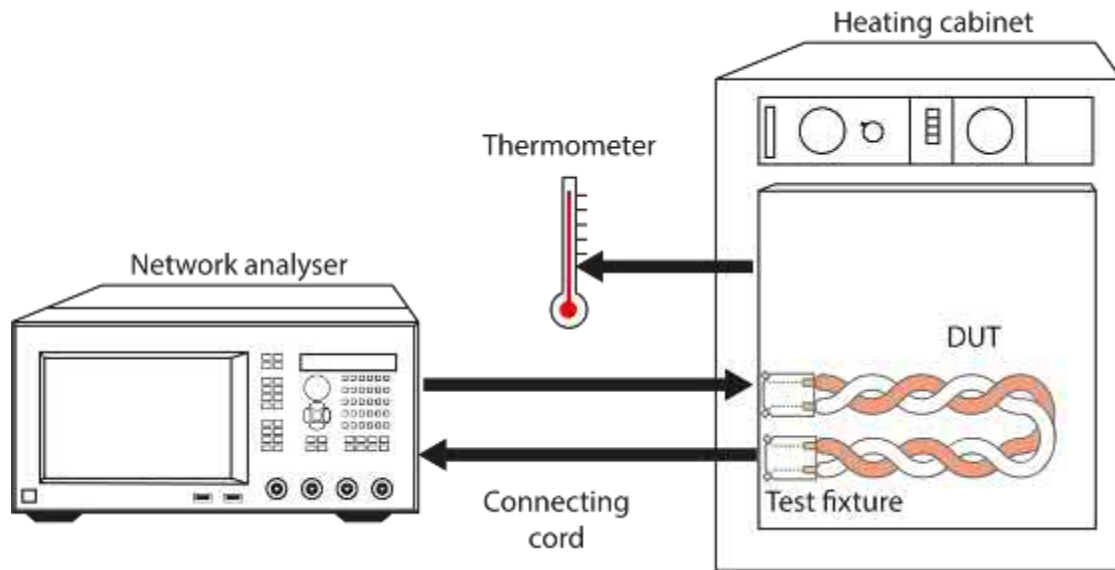

Figure 55 – Measurement setup with heating cabinet

Figure 55 shows the experimental setup (see section 8.2.3). For the measurements the wrapped copper cable with a length of 30 m is placed in a heating cabinet and the cable is gradually heated to various temperatures. The starting point is a typical room temperature of 20 °C. The ends of the copper cable are connected to a network analyser (E5071B from Agilent [116]). These spectral measurements are each determined at intervals of 10 K. This results in nine measurements, starting at 20 °C up to 100 °C. The frequency is measured from 1 MHz to 3 GHz to investigate the influence of heating up to 3 GHz.

For reference purposes, the limit-line curves for cables of Cat. 8.2 according to IEC 61156-9 [27, 28] are shown in figure 56, figs. 58 to 62. These are valid at an environmental temperature of 20 °C and exist up to 2 GHz. For higher frequencies they were drawn in dotted lines.

6.3 Insertion Loss in Relation to Higher Temperatures

Figure 56 shows the measured Insertion Loss curve in decibels (dB) against the frequency in megahertz (MHz). As described in section 2.7.1, the Insertion Loss describes the logarithmic ratio of output and input power. Due to skin effect, the Insertion Loss depends on the frequency. Therefore the attenuation of higher frequencies is higher than the attenuation of lower frequencies.

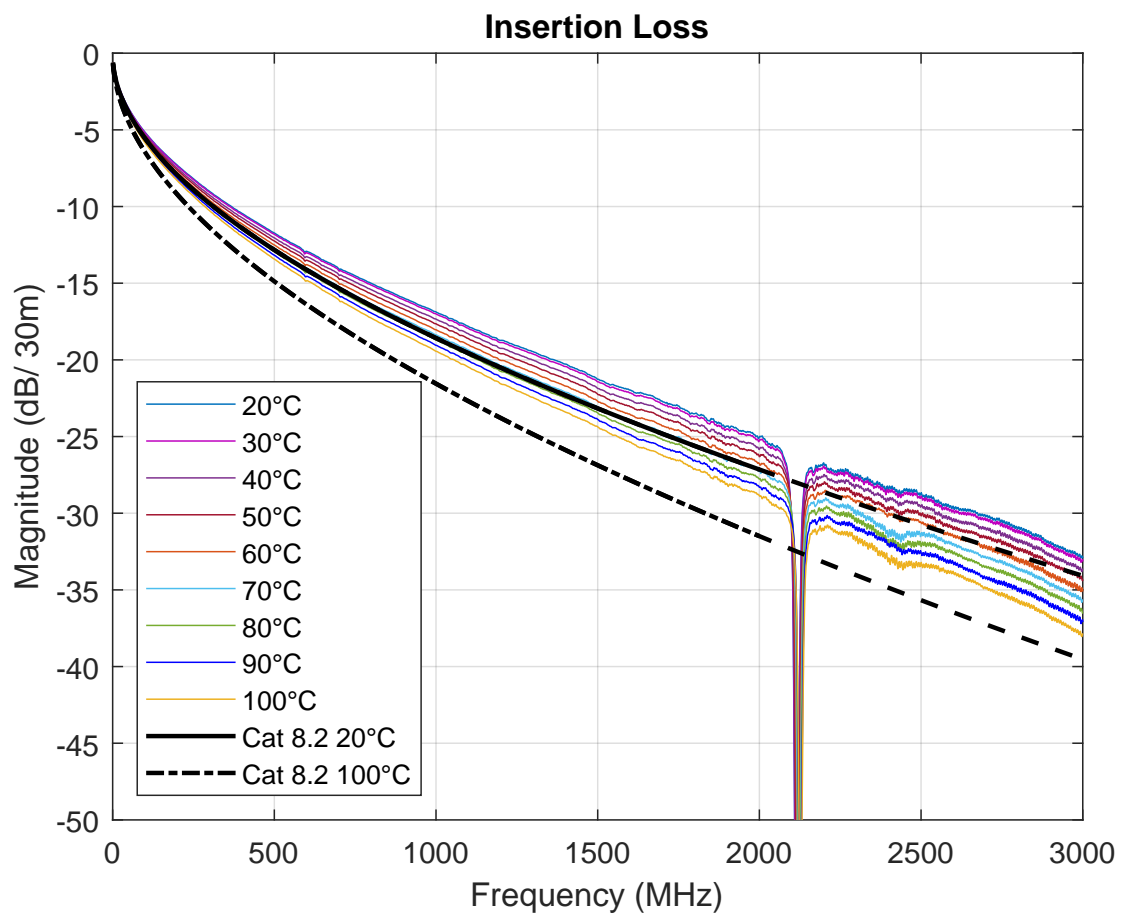

Figure 56 – IL as a function of temperature, cable Cat 8.2 and guideline value for 100 °C

Regarding the temperature dependence, the results of the attenuation measurement clearly show an increase in the Insertion Loss with increasing temperature. This is

Transmission Performance in Relation to Higher Temperatures

due to the temperature-dependent resistance of the metallic conductor. It can be expected that a higher operating temperature of the cables results in an increased attenuation. However, it can be noted that up to an operating temperature of 60 °C the requirements of category 8.2 are fulfilled. This is due to the large distance between the Insertion Loss of the cable and the limit curve of category 8.2. At a frequency of 2.1 GHz, the curve shows a the curve shows a frequency suck out. This is caused by production-related processes during stranding (see section 3.2 for more details).

The wiring standard ISO/ IEC 11801-1 [117, pp. 96-97] predicts an increase in attenuation as a function of the temperature increase of 0.2 % per 1 K for shielded cables. This requirement is not only fulfilled by the device under test, but is even underrun. The average increase per 1 K is only 0.18 % per 1 K for the measurement at 100 °C relative to the measurement at 20 °C. According to ISO/IEC 11801-1 the expected increased guideline values of the limit value curve by 100 °C are indicated by dotted lines. For higher frequencies it was marked as extrapolated dotted.

Figure 57 presents the increased Insertion Loss (IL) per 10 K in relation to the Insertion Loss at a temperature of 20 °C.

Transmission Performance in Relation to Higher Temperatures

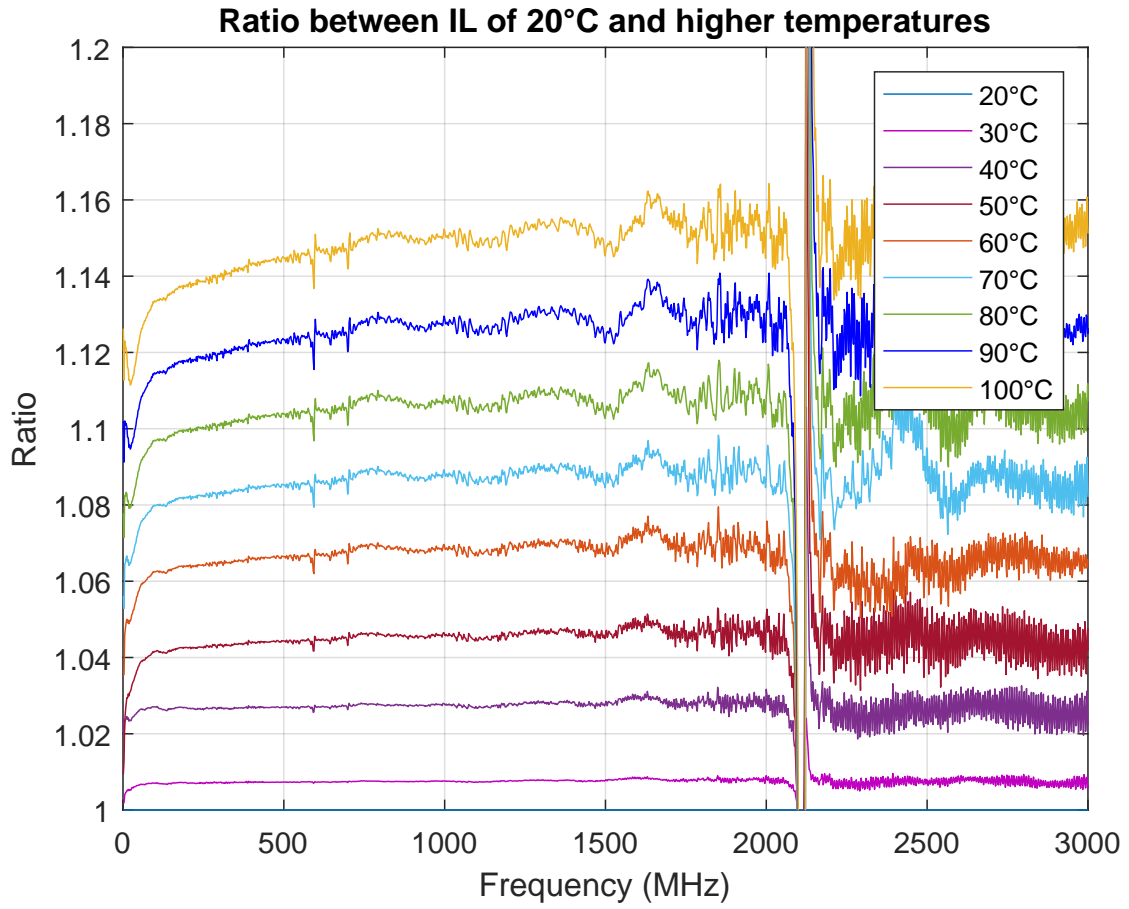

Figure 57 – Ratio between IL at 20 °C up to 100 °C

6.4 Return Loss in Relation to Higher Temperatures

As already described in section 2.7.2, the Return Loss is the ratio of the backscattered power, i.e. the power of the echo, to the input power [78, p. 29]. The Return Loss is shown in figure 58. For reasons of clarity, only the values for a typical room temperature of 20 °C, the standardized maximum operating temperature of 60 °C and the maximum measured temperature of 100 °C are shown below.

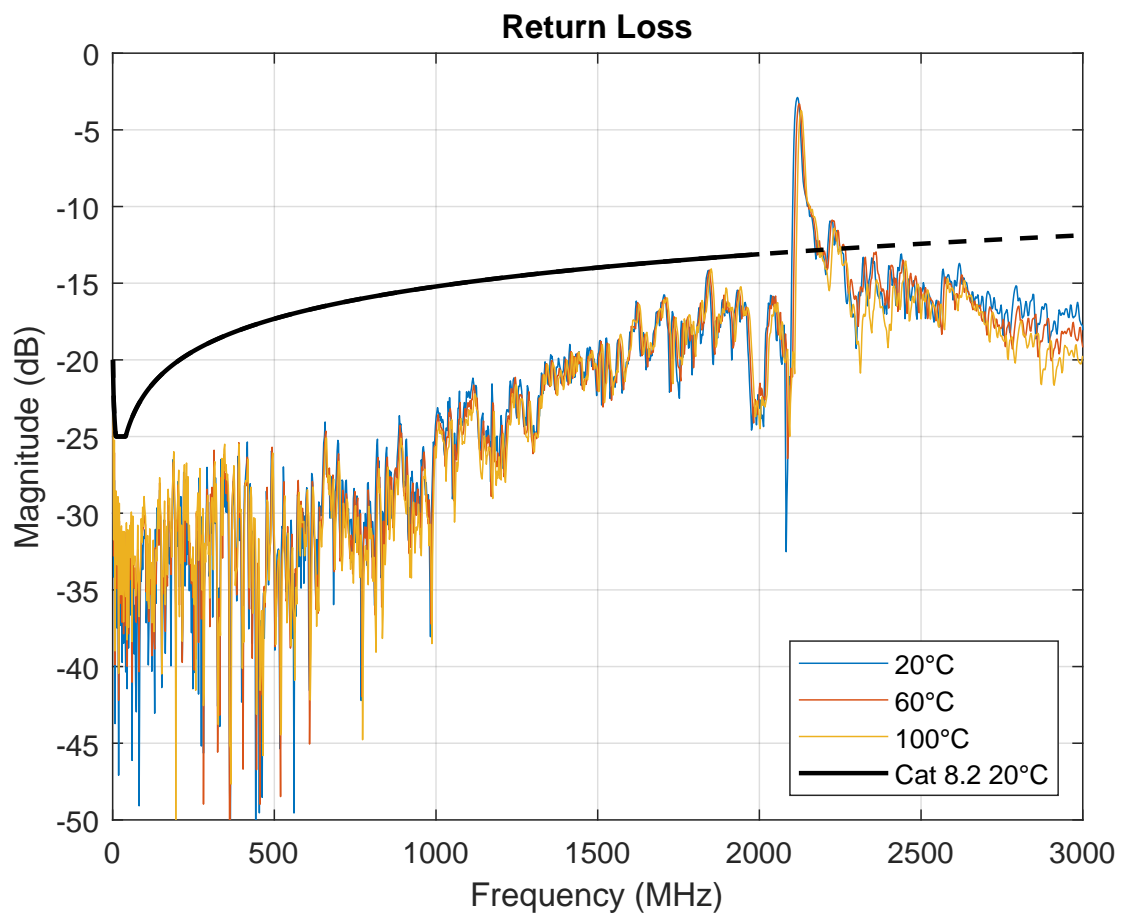

Figure 58 – RL as a function of temperature and cable Cat 8.2

The Return Loss also shows changes over the frequency. However, the change does not show a uniform trend as for the Insertion Loss. At a frequency of 2.1 GHz there

Transmission Performance in Relation to Higher Temperatures

is a frequency offset. This is also due to regular mechanical displacements during cable production, as with Insertion Loss (see section 3.2 for more details).

On closer examination of the lower frequencies (see figure 59), it can be shown that the Return Loss decreases for higher temperatures.

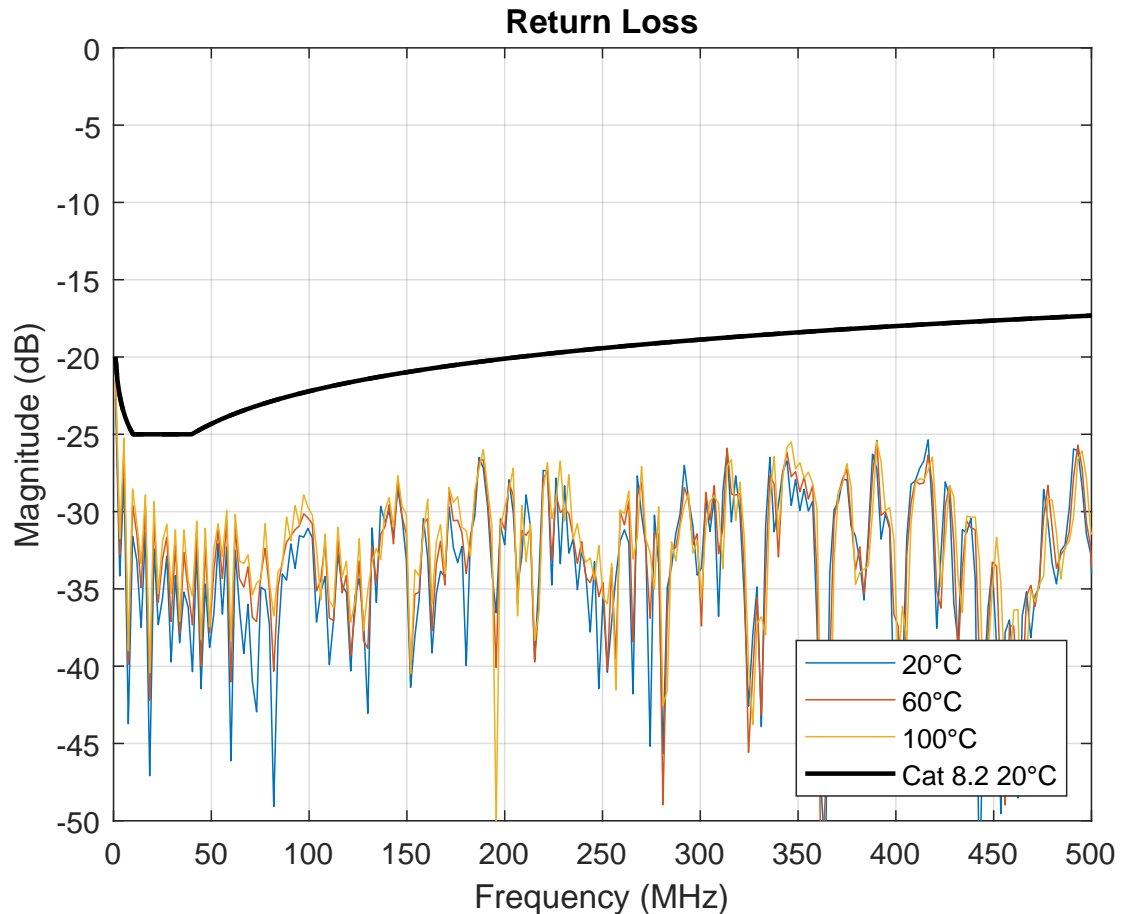

Figure 59 – RL of lower frequencies as a function of temperature and cable Cat 8.2

For higher frequencies (see figure 60) the Return Loss increases at higher temperatures. This may be related to the higher Insertion Loss at higher temperatures. If the attenuation of the signals is higher, there is also less back scattering. In addition, a

Transmission Performance in Relation to Higher Temperatures

frequency offset can be detected. This could be due to a change in material. This hypothesis has to be further investigated and strengthened.



Figure 60 – RL of higher frequencies as a function of temperature and cable Cat 8.2

6.5 Near End Crosstalk in Relation to Higher Temperatures

As already described in section 2.7.3, the Near End Crosstalk describes the influence of a Twisted Pair into another Twisted Pair at the beginning of a cable. For this measurement a signal is transmitted into a Twisted Pair. The Near End Crosstalk gives the ratio of the power of the over-coupled signal of a Twisted Pair to the power of the input signal of another Twisted Pair.

The measurements of the temperature dependency of the near end attenuation are shown in figure 61. Differences in the measurements are recognizable, but no statement can be made about the influence of the temperature.

Transmission Performance in Relation to Higher Temperatures

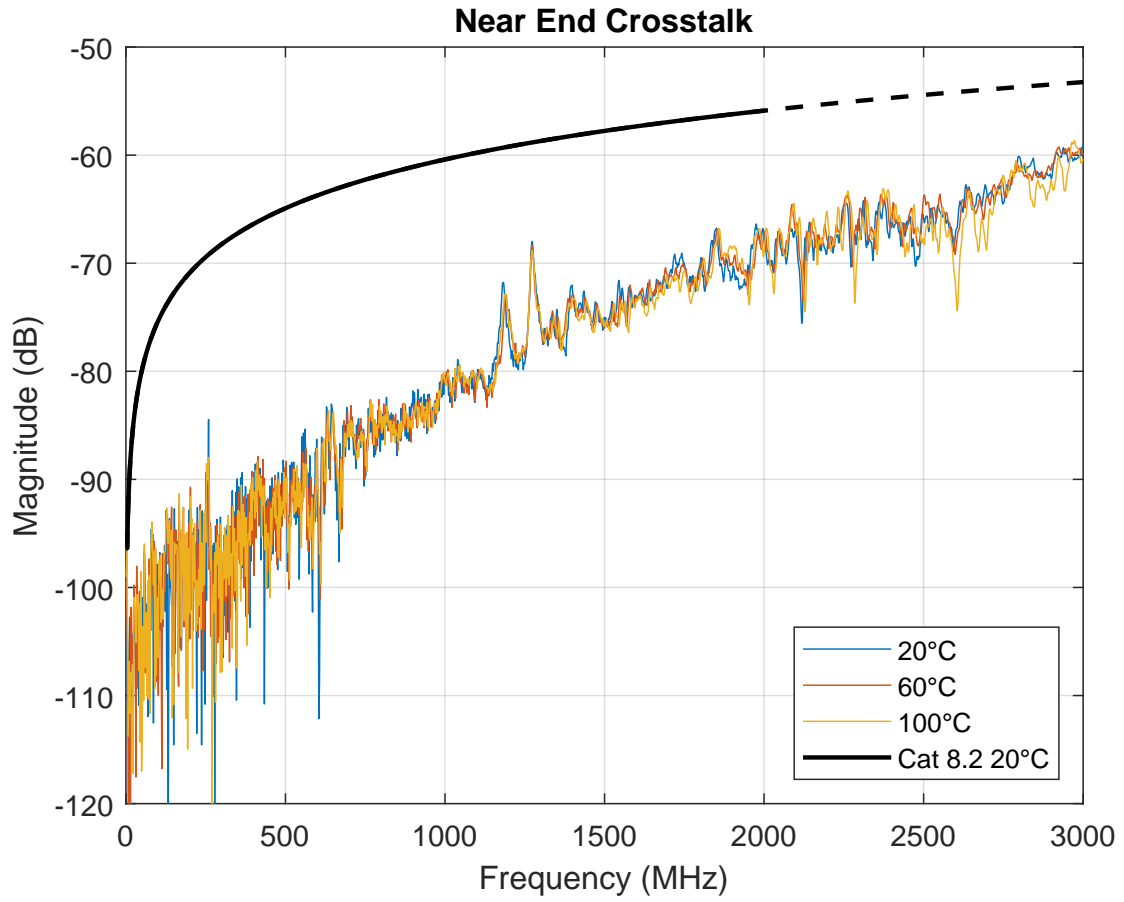

Figure 61 – NEXT as a function of temperature and cable Cat 8.2

6.6 Far End Crosstalk in Relation to Higher Temperatures

As described in Chapter section 2.7.4, the Far End Crosstalk is a measurement of the crosstalk of a Twisted Pair to another Twisted Pair. The Far End Crosstalk is dependent on the cable length. Because of this, the Far End Crosstalk is related to the Insertion Loss. This ratio is called the Attenuation to Crosstalk Ratio at the Far End (ACRF) and is shown in figure 62.

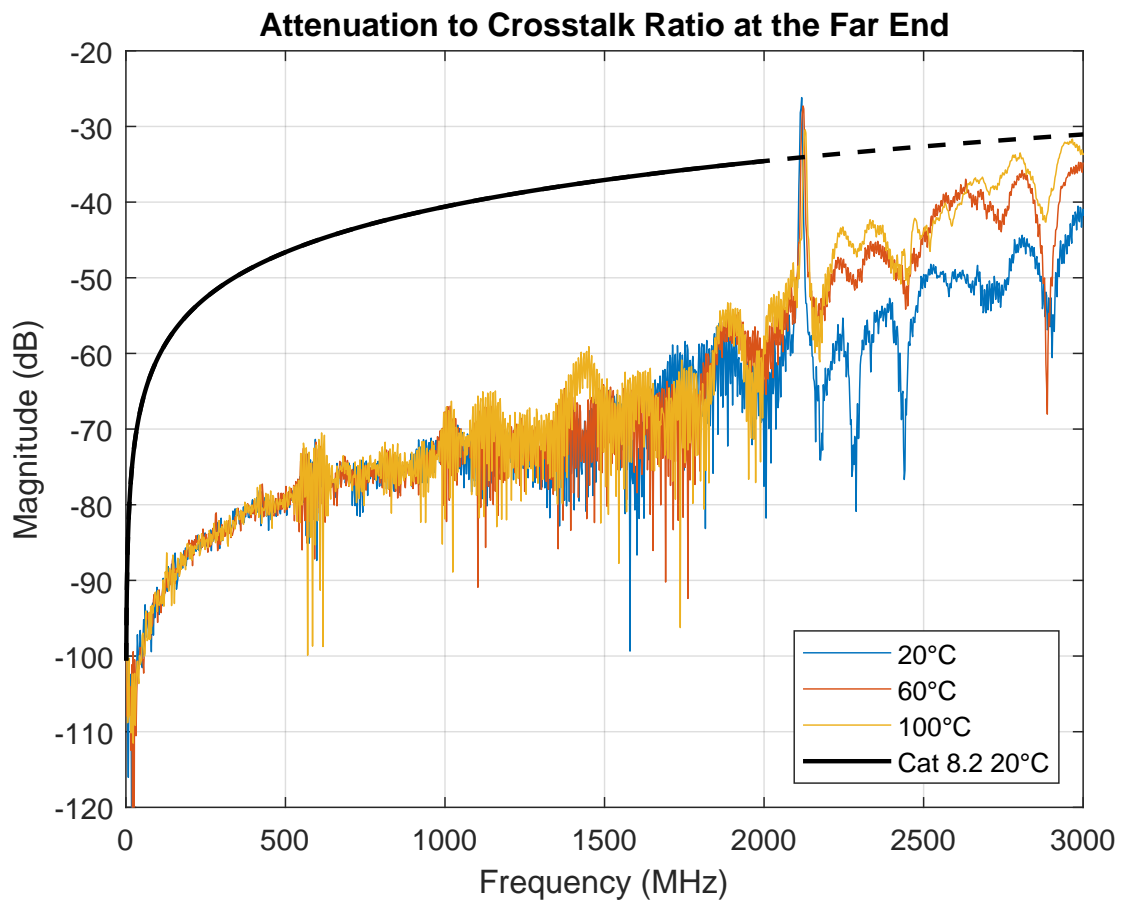

Figure 62 – ACRF as a function of temperature and cable Cat 8.2

Transmission Performance in Relation to Higher Temperatures

Similar to the Near End Crosstalk, differences in the different measurements are recognizable. But no clear statement can be made about the change caused by the temperature.

6.7 Experiment Setup and Measurements

In section 6.2, the spectral properties of the copper cable were measured at different temperatures. Changes in the Insertion Loss (see section 6.3) were mainly observed. This increased Insertion Loss is expected to have a large influence on data transmission. In order to specify these influences during data transmission better, a further measurement setup was developed. The aim of this measurement setup is to visualize and analyse the deviations of a transmission at room temperature and a temperature of 100 °C. The Eye Patterns of a data transmission with a data rate of 1 GHz at a temperature of 20 °C and at a temperature of 100 °C are examined.

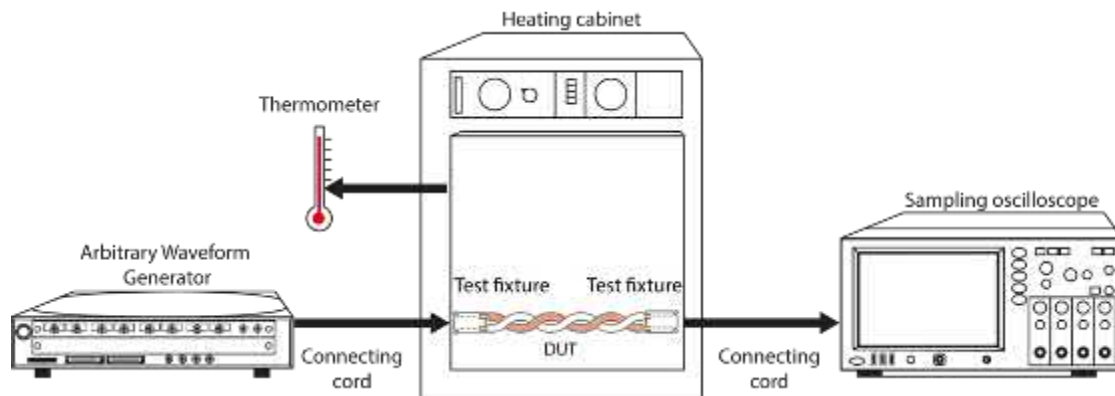

Figure 63 – Measurement setup with heating cabinet for Eye Pattern

Figure 63 shows the next experimental setup (see section 8.2.4). For the measurements the wrapped copper cable with a length of 30 m, is placed in a heating cabinet and the cable is gradually heated to two temperatures. The starting point is again a typical room temperature of 20 °C. The second measurement has a temperature of 100 °C.

The ends of the copper cable are connected to an arbitrary waveform generator (AWG70000A from Tektronix [118]) and a sampling oscilloscope (DSA8200 from

Transmission Performance in Relation to Higher Temperatures

Tektronix [119]). The arbitrary waveform generator sends a pseudo statistical PAM 5 signal (pulse amplitude modulated signal with five data level) with a data rate of 0.25 GBit/s over one pair of a four pair cable. The sampling oscilloscope receives all signals and arranges them all above each other. The result is an Eye Pattern diagram. The Eye Pattern diagram shows the signal quality. The greater the distance between the measuring points the better the signal quality is and therewith the cable performance.

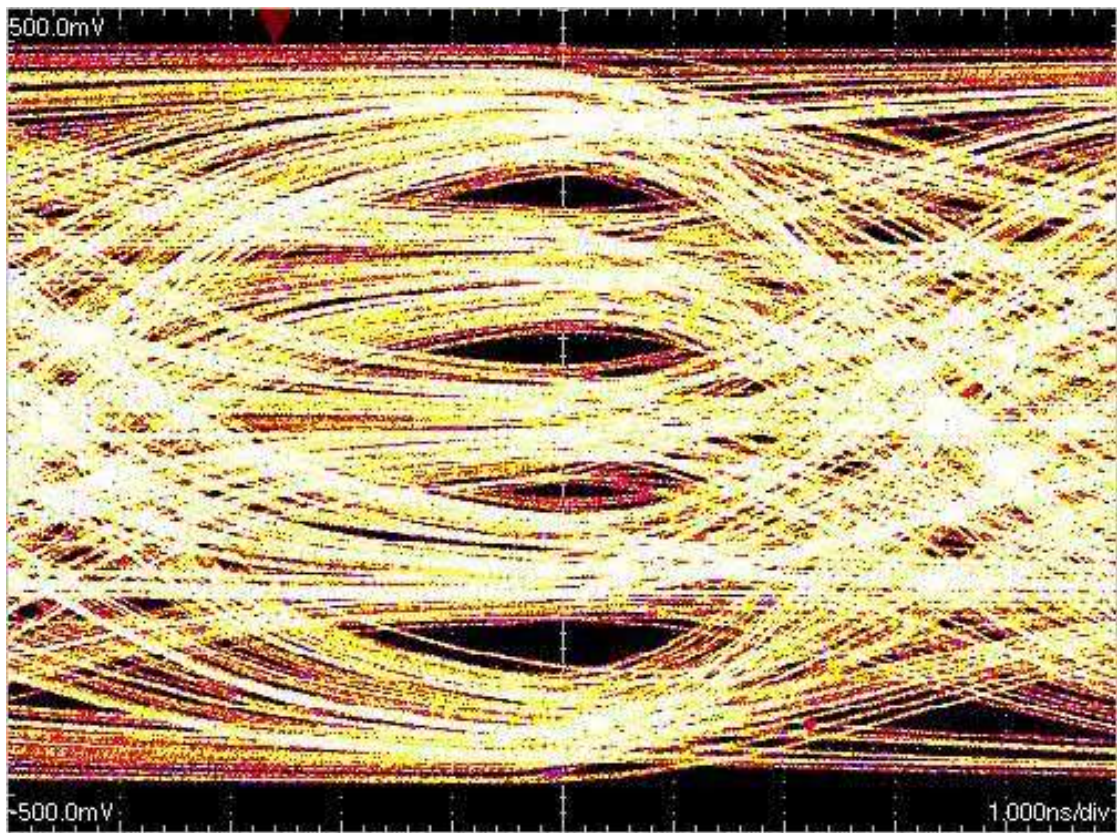

Figure 64 – Eye Pattern of PAM 5 with a data rate of 1 GBit/s at a temperature of 20 °C

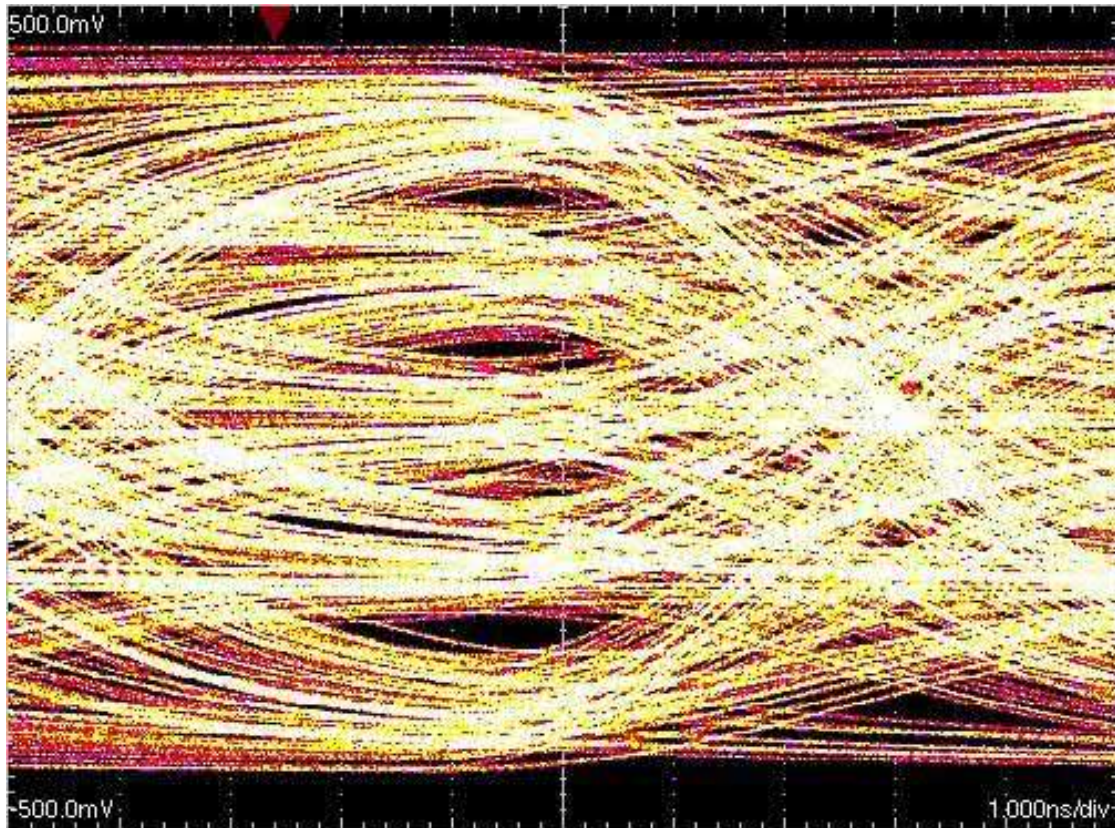

Figure 65 – Eye Pattern of PAM 5 with a data rate of 1 GBit/s at a temperature of 100 °C

These Eye Patterns are measured for 20 °C and 100 °C. Figure 64 and figure 65 show the results of the measurements. The difference of the four distances depends on the pseudo statistical signal sequences. Regarding the temperature dependence, the results of the Eye Pattern measurement clearly show an eye-closure with increasing temperature. This is due to the temperature-dependent resistance of the metallic conductor and is similar to the results of the Insertion Loss measurements. The higher the Insertion Loss of the cable the smaller the signal at the end of the cable and the smaller the distances of the Eye Pattern.

The eye height of the upper eye has decreased from 37.5 mV to 20.8 mV. The second eye has decreased from 33.3 mV to 16.7 mV. The eye height of the third eye has

Transmission Performance in Relation to Higher Temperatures

decreased from 12.5 mV to 8.3 mV. The fourth eye has decreased from 50 mV to 33.3 mV. This means that at an operating temperature of 100 °C instead of 20 °C, the eye openings are on average 40 % smaller.

It is noticeable that the third eye opening from above is clearly more closed than the other eye openings. The reasons for this are not completely clear. Most likely this is due to a badly calibrated arbitrary waveform generator, which can only be corrected with additional software and a real-time oscilloscope from the same manufacturer. Several repetitions of this test resulted in the same results with differently sized eye openings.

6.8 Experimental Summary of Higher Temperature

Chapter 6 has shown the changes in data transmission characteristics of a symmetrical copper cable in relation to the temperatures between 20 °C to 100 °C. It has been seen that, with increasing temperature, the Insertion Loss also increases as expected. Due to the reserves of the cable, the attenuation is so low that the limits set in the standard ISO /IEC 11801-1 for an environmental temperature of 20 °C are still maintained, even at an operating temperature of 60 °C. The average increase of the Insertion Loss as a function of the temperature increase is 0.18 % per 1 K. This is below the allowed 0.2 % per 1 K of the international standard ISO /IEC 11801-1. The increase of Insertion Loss is due to the temperature-dependent resistance of the metallic conductor. Conversely, this means that a thicker conductor of a cable leads to less heating and thus the Insertion Loss increases less strongly. This should be taken into account when selecting cables for higher operating temperatures.

Differences are also apparent for the Return Loss and the attenuation to crosstalk ratio at the far end. This can be associated with the Insertion loss. For the Near End Crosstalk, the temperature dependence changes are not detectable or very low.

In summary, it could be stated that, despite the temperature increase, the requirements of the cable category 8.2 can be fulfilled for the prototype for the Return Loss, Near End and Far End Crosstalk. This is due to sufficient distance between the cable and the limit line at an operating temperature of 20 °C. The increased Insertion Loss for higher temperature is below the allowed 0.2 % per 1 K. All in all this chapter has shown that the changes in the transmission properties can be predicted up to 100 °C and have no harmful influences.

With regard to data transmission at higher temperatures, it should be noted that increased Insertion Loss reduces data transmission. This could be clearly seen in the

Transmission Performance in Relation to Higher Temperatures

comparison of the eye diagrams at 20 °C and 100 °C. The data transmission at higher temperatures is not affected. Due to the increased Insertion Loss, the eyes close on average by 40 %, which will also lead to an increased bit error probability. When using data cables at higher temperatures, care should therefore be taken to reduce the data rate or the length of the data cables, so that error-free data transmission can be guaranteed.

7 Conclusion and Future Work

In this chapter the objectives are compared and discussed with the achieved results. A summary of new contribution to knowledge is presented. Finally, recommendations for further work are proposed.

7.1 Conclusion

In this thesis the topic of higher order Pulse Amplitude Modulation, implemented in a copper Ethernet cable environment, has been examined. The main question of this thesis was: What is the potential of Pulse Amplitude Modulation for transmission over existing categories of copper cables in terms of increasing the data bandwidth?

Objectives were set to answer this question. These objectives were divided into 3 areas. These objectives and how these objectives have been achieved in this thesis are described in the following: The first objective of this thesis was to determine the minimum performance requirements of twisted pair cables for a future 100 GBit/s transmission and whether this can be achieved with the current cabling technology.

To achieve this objective the insertion loss over frequency was investigated in detail and compared with the limit values of the cable categories. Moreover the relationship between cable structure, lay length and Insertion Loss was presented (see chapter 3). Furthermore, the frequency spectrum of a pulse amplitude modulation was examined in detail. A frequency bandwidth of at least 2 GHz is necessary for the transmission

of 100 GBit/s over 4 pairs. Based on this finding, at least the highest cable category, Cat 8.2, is necessary for transmission (see section 2.9). Another objective was to determine the necessary channel equalization and pre-emphasis to maximize the data length product.

For this purpose, the cable was examined spectrally in detail. Besides the insertion loss, the return loss, the near-end crosstalk and the far-end crosstalk were measured and analysed (see chapter 3). On the basis of these investigations the required equalization could be realized. First the Pulse Amplitude Modulation was simulated. These modulations were then supplemented by the Insertion Loss of the copper cable and resulted in the simulation of the attenuated signal at the end of the cable. The last simulation shows the pre-emphasised signal which results in an attenuated but correct signal at the end of the Twisted Pair cable (see chapter 4).

Subsequently, these theoretical simulations were implemented by practical transmissions. Three different Pulse Amplitude Modulations were used: PAM 8, PAM 16 and PAM 32. These were transmitted over different lengths between 10 and 100 m and the bit error probability was analysed (see chapter 5). The transmission of data rates up to 100 GBit/s over different lengths has shown that considerably higher data rates can be realized compared to previously standardized data rates. Taking into account a minimum requirement of a bit error probability of at least 10⁻¹² or better, this thesis has shown that the following maximum bit rates can be realized using existing cables:

Up to now, a data rate of maximum 10 GBit/s has been standardized for cable lengths up to 100 m and shorter. For a cable length of 50 m a data rate of 20 Gbit/s instead of 10 GBit/s could be realized.

For cable lengths of 30 m and shorter, a data rate of 40 GBit/s has been standardized up to now. In this thesis the data rate could be increased from 30 m to 50 GBit/s. The

greatest success could be realized with a cable length of 10 m and 90 GBit/s. This is more than a doubling of the standardized data rates.

As a third objective of this thesis, a guidance for the installation was requested to ensure that the research presented in this thesis is of practical use. Section 3.1.4 and section 3.1.5 have shown that the crosstalk of shielded cables is extremely low. The distance between the measured values and the limit values corresponds to high reserves. Due to the low crosstalk of the cables, external influences are so low that they can be neglected, as they are much smaller than the reserves. The behaviour is different for influences that occur directly in the cable. For the transmission of energy and data at the same time, significantly higher temperatures are generated. These higher temperatures are fundamental, first order, parameters and have a significant impact on the performance. By installing the data cables for data and power at the same time, the cables are exposed to significant heating. This heating changes the transmission properties of the cable. Until now, this change in transmission properties has only been investigated up to a maximum temperature of 60 °C. In this thesis temperatures of up to 100 °C were realized and the results were analysed. It has been shown that the heating of cables up to a temperature of 100 °C is predictable. This possible heating must be taken into account during installation. For this purpose, the data rate of the data transmission can be reduced or the cable length can be reduced according to the heating of the cable (see chapter 6).

In summary, the new contribution to knowledge can be described as follows:

- To transmit 100 GBit/s with a PAM modulation a usable bandwidth of 2 GHz is required. This is currently achievable with cable category 8.2.
- Up to now the bit error rate could only be created for a Pulse Amplitude Modulation of a maximum of 4 voltage levels. For the determination of the Bit

Error Rate of a Pulse Amplitude Modulation of PAM 8, PAM 16 and PAM 32 a new concept was developed in this thesis.

- With a bit error probability of at least 10⁻¹² or better, the following data rates could be achieved, thus increasing previous standardized data rates:
 - 20 GBit/s with PAM8 over 50m
 - 50 GBit/s with PAM8 over 30m
 - 90 GBit/s with PAM8 over 10m
- The previous standardized temperature of maximum 60 °C was investigated up to a temperature of 100 °C. The increased Insertion Loss for higher temperatures is less than the permissible 0.2 % per 1K. Overall, it can be stated that the changes in the transmission properties can be predicted up to 100 °C and have no harmful influences, given that pre-emphasis can be used to compensate for the frequency dependency.

Overall, the research presented here has shown that the prototype cable can be used to realize the technical feasibility of transmitting up to 90 GBit/s over symmetrical copper cabling. It has identified the way forward to reaching higher speed data and, thus, it is anticipated that opportunities exist for the development of future generations of high-speed copper cabling for the expansion of the network infrastructure of the data centre based on the work presented in this thesis.

7.2 Suggestion for Future Work

Higher data rates are increasingly in demand, a trend that looks to continue, and copper cables continue to have a significant role in the data communications infrastructure. Further investigations are therefore advantageous for the practical implementation of data transmission via copper cables. This thesis addressed data transmission by means of Pulse Amplitude Modulation. However, in order to achieve a further improvement of data transmission via copper cables in practice, a number of future tasks should be carried out as listed below. Different directions are suggested for future work:

7.2.1 Modulation

In this thesis, only data transmissions using higher order Pulse Amplitude Modulations in combination with a Raised Cosine filter was investigated. This type of transmission is already used in practice and is therefore most likely to be accepted by industry. However, there is still an open research question on whether other modulation techniques can achieve higher data rates via copper cables. For example, the Orthogonal Frequency Division multiplexing could be investigated in more detail. Several orthogonal carriers are used for data transmission. This modulation can adapt very well. In case of interference, often only single carriers are disturbed, so that all other carriers can be used further.

Another consideration would be transmission via a phantom circuit. For example, the output voltage could be reduced from 1 V peak to peak to 0.8 V peak to peak per wire pair. The remaining 0.2 V could be used for the phantom circuit. This could then be combined over four pairs, so that the phantom circuit in turn results in an output voltage of 0.8 V peak to peak as is already the case for 4 wire pairs. This

could create an additional channel for data transmission without having to change the existing cable construction, thus increasing the number of “lanes” from four to five with the potential to increase the bandwidth accordingly.

7.2.2 Practical Implementation of the Results

In this thesis the main focus was on the transmission over copper cables. Connectors were not used. In further investigations, a device under test station with connectors and cables should be investigated and analysed.

Furthermore, in the progress of the work reported here, transmissions and measurements were realized in defined laboratory environments. The measurements were subject to a few limitations. For example, the output of the AWG is limited by a maximum voltage of 2 V peak to peak.

Therefore, the measurements need to be integrated and tested in a network structure in order to put the findings of the work into practice.

7.2.3 Bit Error Rate

An initial estimation of the Bit Error Rate was made using repetitive bit sequence and the Keysight’s Eye Contours software. This software made it possible to analyse and evaluate the different transmissions approaches. A next step would be to develop and produce a bit error tester for higher order Pulse Amplitude Modulation. In further investigations, the results already obtained should be repeated by means of such a bit error tester and the results validated.

7.2.4 Standards

This thesis has shown that there are prototype cables that reach much higher bandwidths than the highest cable standard Cat. 8.2. Following this work, the results could be used to develop a new cable standard up to 3 GHz, for example. The values of the standards extrapolated in chapter 3 could be used for this purpose.

Furthermore, a new standard for the transmission of higher bandwidths over shorter cable lengths could be standardized. For example 100 GBit/s over 10 m copper cable.

8 Appendix

8.1 Publication

- K. Seitz, A. Oehler, and D. Schicketanz, "Wärmeentwicklung bei Fernspeisung bis 100 W," in *ITG Fachtagung*, 2016
- A. Oehler, Y. Engels, R. Schmid, and K. Seitz, "100 Gbit/s über 4-paarige symmetrische Verkabelung – Vision oder Realität?" *Horizonte*, vol. 48, pp. 49–52, 2016
- D. Schicketanz, A. Oehler, and K. Seitz, "Einfluss des Kabelverlegesystems auf das Temperaturprofil im Kabelbündel bei Fernspeisung - Bundle temperature profil as function of cable tray systems," in *Fachtagung Kommunikationskabelnetze*, vol. 24, Köln, Germany, 2017, pp. 60–66
- K. Seitz, H. Sari, A. Oehler, and Y. Engels, "Verhalten der Hochfrequenzübertragungseigenschaften von symmetrischen Kupferdatenkabeln in Abhängigkeit der Temperatur," *Horizonte*, vol. 50, pp. 11–15, 2017

8.2 Pictures of Measurements Setups

8.2.1 Picture of Measurement Setup for Spectral Measurements

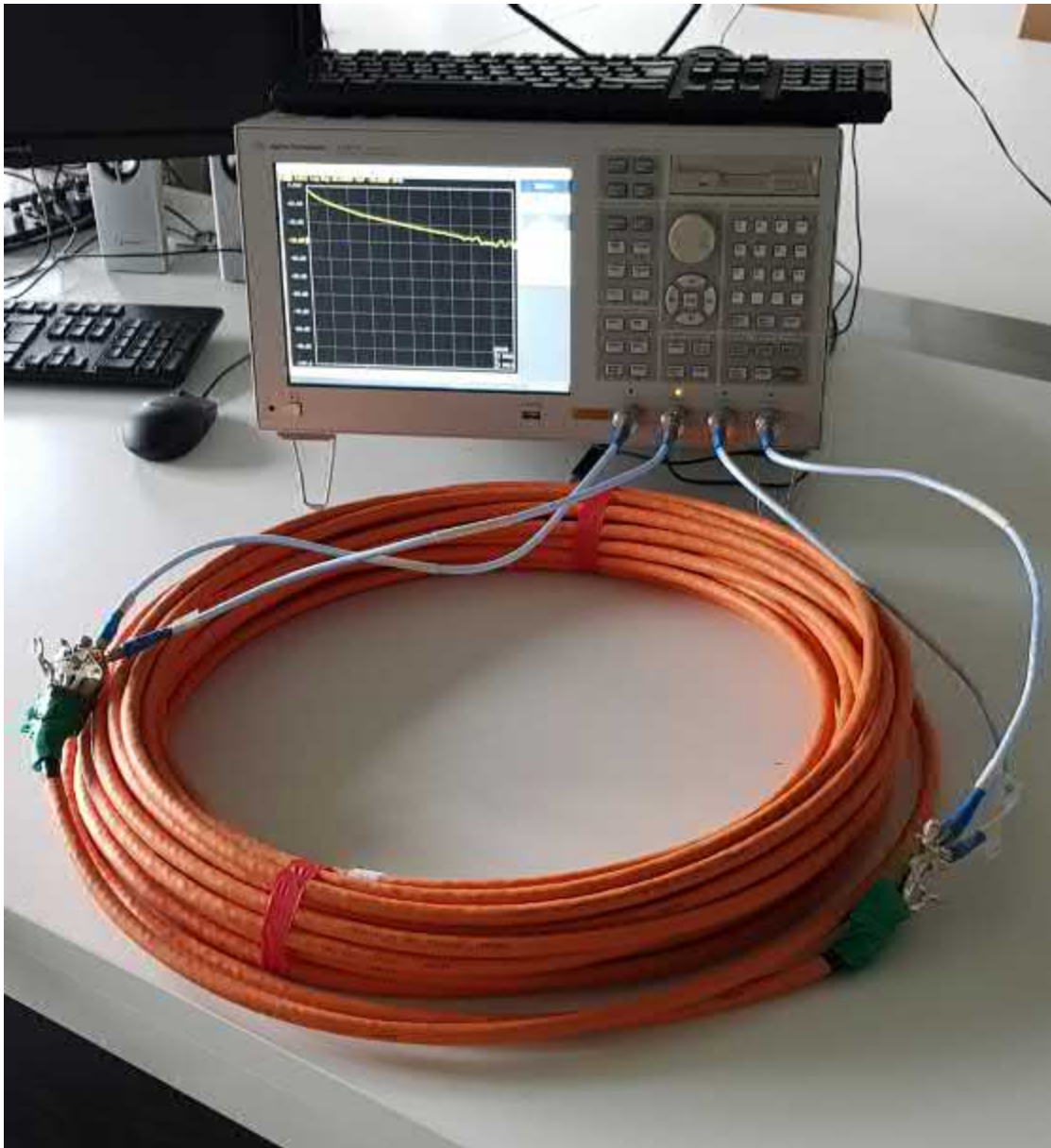

Figure 66 – Picture of measurement setup for spectral measurements

8.2.2 Picture of Measurement Setup for Data Transmission and Eye Pattern

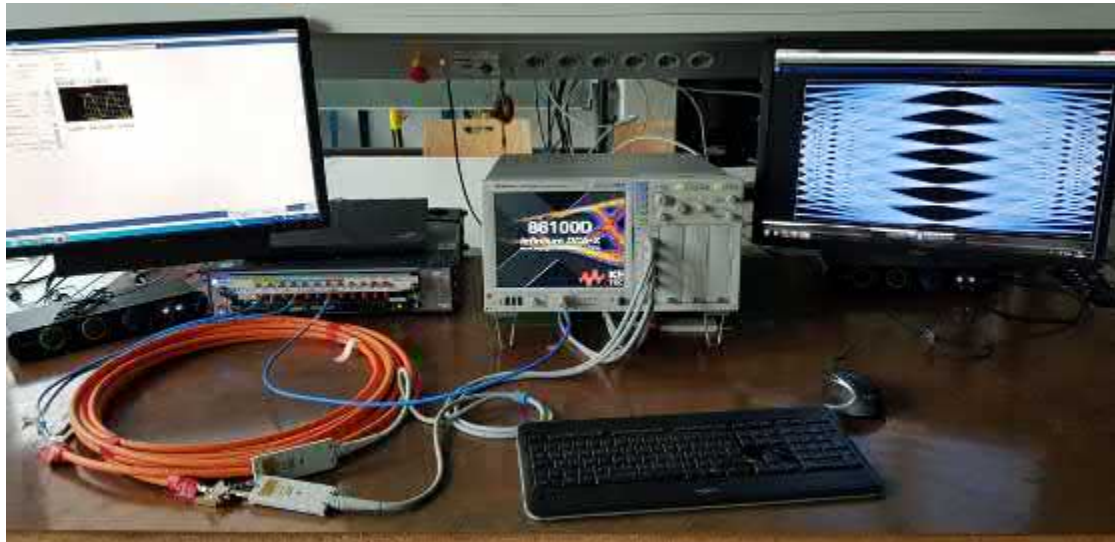

Figure 67 – Picture of measurement setup for data transmission and Eye Pattern

8.2.3 Picture of Measurement Setup with Heating Cabinet



Figure 68 – Picture of measurement setup with heating cabinet

8.2.4 Picture of Measurement Setup with Heating Cabinet for Eye Pattern



Figure 69 – Picture of measurement setup with heating cabinet

8.3 Picture and Design Drawing of Test Fixture

8.3.1 Design Drawing of Test Fixture

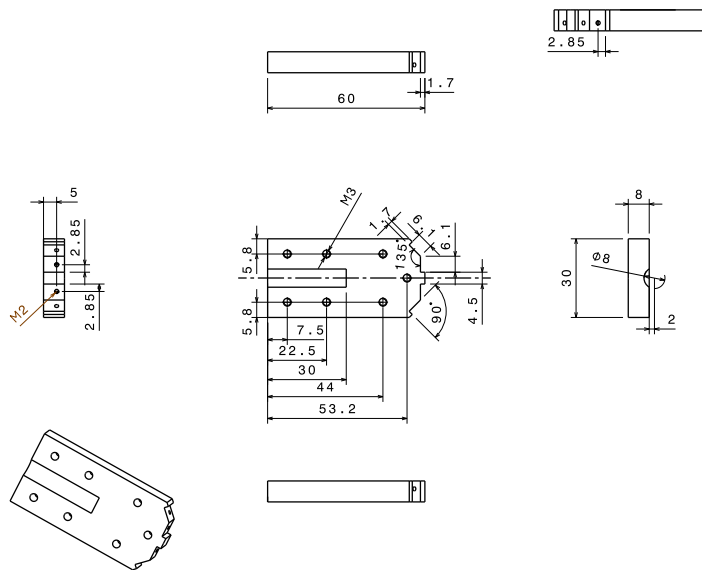

Figure 70 – Design drawing of test fixture

8.3.2 Design Drawing of Plastic Holder

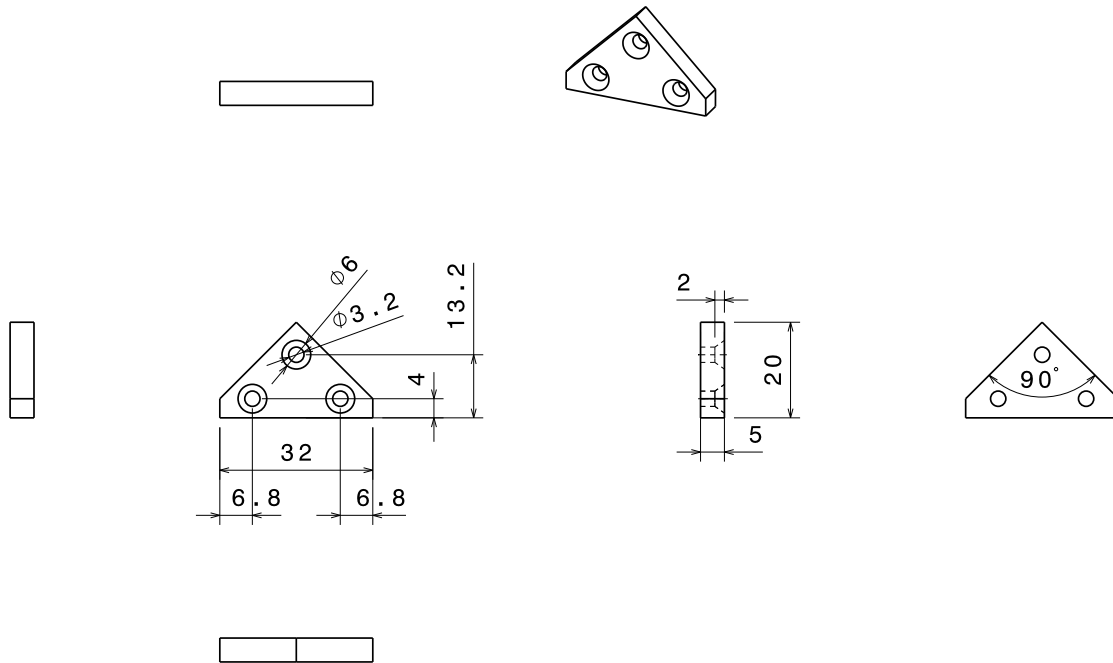

Figure 71 – Design drawing of plastic holder

8.3.3 Picture of Test Fixture

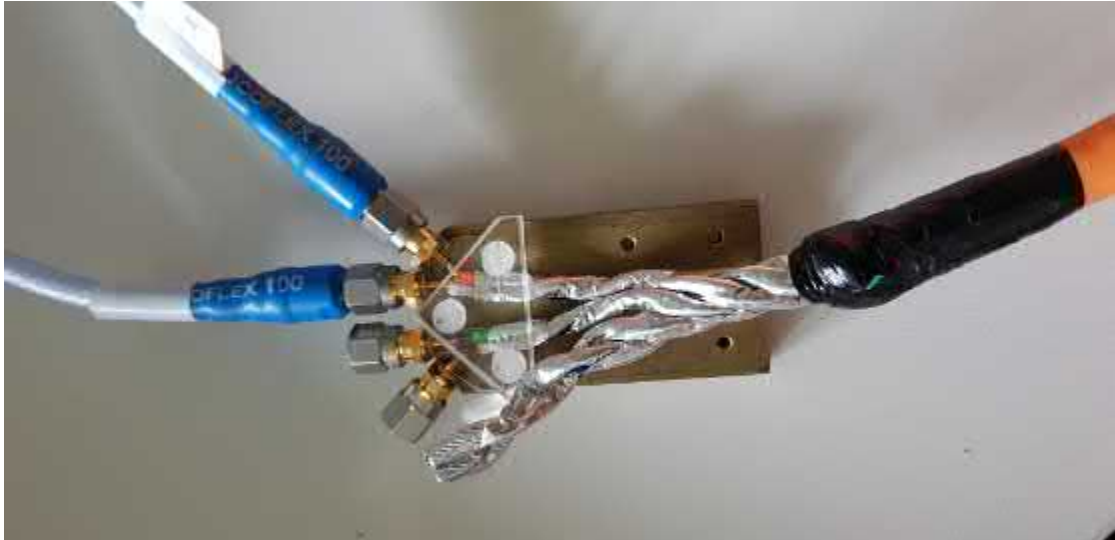

Figure 72 – Picture of test fixture

8.4 Quantity of Combinations of the Transmitted Signal

Table 11 – Quantity of combinations of the transmitted signal

1. Symbol	2. Symbol	Quantity
-1	-1	11
-1	-0.866666666666667	13
-1	-0.733333333333334	16
-1	-0.6	13
-1	-0.466666666666666	17
-1	-0.333333333333334	7
-1	-0.2	17
-1	-0.066666666666666	19
-1	0.066666666666666	13
-1	0.2	11
-1	0.333333333333334	17
-1	0.466666666666666	14
-1	0.6	9
-1	0.733333333333334	16
-1	0.866666666666666	17
-1	1	21
-0.866666666666667	-1	13
-0.866666666666667	-0.866666666666667	16
-0.866666666666667	-0.733333333333334	15
-0.866666666666667	-0.6	21

Continued on next page

Table 11 – continued from previous page

1. Symbol	2. Symbol	Quantity
-0.866666666666667	-0.466666666666666	13
-0.866666666666667	-0.333333333333334	14
-0.866666666666667	-0.2	24
-0.866666666666667	-0.066666666666666	13
-0.866666666666667	0.066666666666666	13
-0.866666666666667	0.2	15
-0.866666666666667	0.333333333333334	16
-0.866666666666667	0.466666666666666	15
-0.866666666666667	0.6	17
-0.866666666666667	0.733333333333334	16
-0.866666666666667	0.866666666666666	19
-0.866666666666667	1	23
-0.733333333333333	-1	10
-0.733333333333333	-0.866666666666667	19
-0.733333333333333	-0.733333333333334	23
-0.733333333333333	-0.6	11
-0.733333333333333	-0.466666666666666	15
-0.733333333333333	-0.333333333333334	16
-0.733333333333333	-0.2	17
-0.733333333333333	-0.066666666666666	11
-0.733333333333333	0.066666666666666	16
-0.733333333333333	0.2	17
-0.733333333333333	0.333333333333334	20
-0.733333333333333	0.466666666666666	14
Continued on next page		

Table 11 – continued from previous page

1. Symbol	2. Symbol	Quantity
-0.7333333333333333	0.6	15
-0.7333333333333333	0.7333333333333334	14
-0.7333333333333333	0.8666666666666666	14
-0.7333333333333333	1	15
-0.6	-1	9
-0.6	-0.8666666666666667	11
-0.6	-0.7333333333333334	21
-0.6	-0.6	14
-0.6	-0.4666666666666666	17
-0.6	-0.3333333333333334	21
-0.6	-0.2	14
-0.6	-0.0666666666666666	17
-0.6	0.0666666666666666	15
-0.6	0.2	15
-0.6	0.3333333333333334	15
-0.6	0.4666666666666666	17
-0.6	0.6	20
-0.6	0.7333333333333334	14
-0.6	0.8666666666666666	20
-0.6	1	18
-0.4666666666666667	-1	10
-0.4666666666666667	-0.8666666666666667	25
-0.4666666666666667	-0.7333333333333334	14
-0.4666666666666667	-0.6	15
Continued on next page		

Table 11 – continued from previous page

1. Symbol	2. Symbol	Quantity
-0.466666666666667	-0.466666666666666	17
-0.466666666666667	-0.333333333333334	10
-0.466666666666667	-0.2	19
-0.466666666666667	-0.066666666666666	19
-0.466666666666667	0.066666666666666	21
-0.466666666666667	0.2	20
-0.466666666666667	0.333333333333334	10
-0.466666666666667	0.466666666666666	9
-0.466666666666667	0.6	12
-0.466666666666667	0.733333333333334	15
-0.466666666666667	0.866666666666666	6
-0.466666666666667	1	14
-0.333333333333334	-1	13
-0.333333333333334	-0.866666666666667	12
-0.333333333333334	-0.733333333333334	17
-0.333333333333334	-0.6	22
-0.333333333333334	-0.466666666666666	11
-0.333333333333334	-0.333333333333334	10
-0.333333333333334	-0.2	14
-0.333333333333334	-0.066666666666666	14
-0.333333333333334	0.066666666666666	21
-0.333333333333334	0.2	16
-0.333333333333334	0.333333333333334	11
-0.333333333333334	0.466666666666666	13
Continued on next page		

Table 11 – continued from previous page

1. Symbol	2. Symbol	Quantity
-0.3333333333333334	0.6	16
-0.3333333333333334	0.7333333333333334	17
-0.3333333333333334	0.8666666666666666	12
-0.3333333333333334	1	13
-0.2	-1	14
-0.2	-0.8666666666666667	20
-0.2	-0.7333333333333334	14
-0.2	-0.6	20
-0.2	-0.4666666666666666	13
-0.2	-0.3333333333333334	15
-0.2	-0.2	17
-0.2	-0.0666666666666666	22
-0.2	0.0666666666666666	21
-0.2	0.2	15
-0.2	0.3333333333333334	20
-0.2	0.4666666666666666	23
-0.2	0.6	17
-0.2	0.7333333333333334	21
-0.2	0.8666666666666666	16
-0.2	1	10
-0.06666666666666664	-1	20
-0.06666666666666664	-0.8666666666666667	21
-0.06666666666666664	-0.7333333333333334	14
-0.06666666666666664	-0.6	18

Continued on next page

Table 11 – continued from previous page

1. Symbol	2. Symbol	Quantity
-0.0666666666666664	-0.466666666666666	11
-0.0666666666666664	-0.3333333333333334	15
-0.0666666666666664	-0.2	19
-0.0666666666666664	-0.066666666666666	14
-0.0666666666666664	0.066666666666666	14
-0.0666666666666664	0.2	17
-0.0666666666666664	0.3333333333333334	15
-0.0666666666666664	0.466666666666666	15
-0.0666666666666664	0.6	19
-0.0666666666666664	0.7333333333333334	8
-0.0666666666666664	0.866666666666666	20
-0.0666666666666664	1	16
0.0666666666666664	-1	22
0.0666666666666664	-0.866666666666667	15
0.0666666666666664	-0.7333333333333334	14
0.0666666666666664	-0.6	16
0.0666666666666664	-0.466666666666666	18
0.0666666666666664	-0.3333333333333334	12
0.0666666666666664	-0.2	16
0.0666666666666664	-0.066666666666666	14
0.0666666666666664	0.066666666666666	16
0.0666666666666664	0.2	15
0.0666666666666664	0.3333333333333334	19
0.0666666666666664	0.466666666666666	23
Continued on next page		

Table 11 – continued from previous page

1. Symbol	2. Symbol	Quantity
0.0666666666666664	0.6	16
0.0666666666666664	0.7333333333333334	17
0.0666666666666664	0.8666666666666666	16
0.0666666666666664	1	29
0.2	-1	14
0.2	-0.8666666666666667	18
0.2	-0.7333333333333334	15
0.2	-0.6	18
0.2	-0.4666666666666666	17
0.2	-0.3333333333333334	18
0.2	-0.2	17
0.2	-0.0666666666666666	18
0.2	0.0666666666666666	12
0.2	0.2	24
0.2	0.3333333333333334	17
0.2	0.4666666666666666	16
0.2	0.6	16
0.2	0.7333333333333334	17
0.2	0.8666666666666666	16
0.2	1	14
0.3333333333333333	-1	15
0.3333333333333333	-0.8666666666666667	14
0.3333333333333333	-0.7333333333333334	12
0.3333333333333333	-0.6	20
Continued on next page		

Table 11 – continued from previous page

1. Symbol	2. Symbol	Quantity
0.3333333333333333	-0.4666666666666666	15
0.3333333333333333	-0.3333333333333334	19
0.3333333333333333	-0.2	15
0.3333333333333333	-0.0666666666666666	19
0.3333333333333333	0.0666666666666666	15
0.3333333333333333	0.2	11
0.3333333333333333	0.3333333333333334	15
0.3333333333333333	0.4666666666666666	20
0.3333333333333333	0.6	12
0.3333333333333333	0.7333333333333334	15
0.3333333333333333	0.8666666666666666	20
0.3333333333333333	1	18
0.4666666666666667	-1	15
0.4666666666666667	-0.8666666666666667	14
0.4666666666666667	-0.7333333333333334	13
0.4666666666666667	-0.6	10
0.4666666666666667	-0.4666666666666666	17
0.4666666666666667	-0.3333333333333334	11
0.4666666666666667	-0.2	23
0.4666666666666667	-0.0666666666666666	13
0.4666666666666667	0.0666666666666666	22
0.4666666666666667	0.2	15
0.4666666666666667	0.3333333333333334	21
0.4666666666666667	0.4666666666666666	25
Continued on next page		

Table 11 – continued from previous page

1. Symbol	2. Symbol	Quantity
0.466666666666667	0.6	20
0.466666666666667	0.733333333333334	16
0.466666666666667	0.866666666666666	20
0.466666666666667	1	12
0.6	-1	18
0.6	-0.866666666666667	11
0.6	-0.733333333333334	11
0.6	-0.6	20
0.6	-0.466666666666666	19
0.6	-0.333333333333334	16
0.6	-0.2	11
0.6	-0.066666666666666	15
0.6	0.066666666666666	16
0.6	0.2	21
0.6	0.333333333333334	11
0.6	0.466666666666666	11
0.6	0.6	13
0.6	0.733333333333334	19
0.6	0.866666666666666	19
0.6	1	15
0.733333333333333	-1	17
0.733333333333333	-0.866666666666667	17
0.733333333333333	-0.733333333333334	22
0.733333333333333	-0.6	16

Continued on next page

Table 11 – continued from previous page

1. Symbol	2. Symbol	Quantity
0.7333333333333333	-0.4666666666666666	10
0.7333333333333333	-0.3333333333333334	17
0.7333333333333333	-0.2	21
0.7333333333333333	-0.0666666666666666	21
0.7333333333333333	0.0666666666666666	21
0.7333333333333333	0.2	15
0.7333333333333333	0.3333333333333334	11
0.7333333333333333	0.4666666666666666	19
0.7333333333333333	0.6	12
0.7333333333333333	0.7333333333333334	18
0.7333333333333333	0.8666666666666666	13
0.7333333333333333	1	13
0.8666666666666667	-1	17
0.8666666666666667	-0.8666666666666667	22
0.8666666666666667	-0.7333333333333334	15
0.8666666666666667	-0.6	15
0.8666666666666667	-0.4666666666666666	14
0.8666666666666667	-0.3333333333333334	14
0.8666666666666667	-0.2	16
0.8666666666666667	-0.0666666666666666	14
0.8666666666666667	0.0666666666666666	16
0.8666666666666667	0.2	20
0.8666666666666667	0.3333333333333334	19
0.8666666666666667	0.4666666666666666	13
Continued on next page		

Table 11 – continued from previous page

1. Symbol	2. Symbol	Quantity
0.866666666666667	0.6	16
0.866666666666667	0.733333333333334	24
0.866666666666667	0.866666666666666	17
0.866666666666667	1	11
1	-1	13
1	-0.866666666666667	15
1	-0.733333333333334	11
1	-0.6	9
1	-0.466666666666666	12
1	-0.333333333333334	17
1	-0.2	18
1	-0.066666666666666	13
1	0.066666666666666	26
1	0.2	20
1	0.333333333333334	18
1	0.466666666666666	20
1	0.6	16
1	0.733333333333334	16
1	0.866666666666666	18
1	1	14

8.5 Transmission over 10 m

8.5.1 Transmission of 10 GBit/s over 10 m

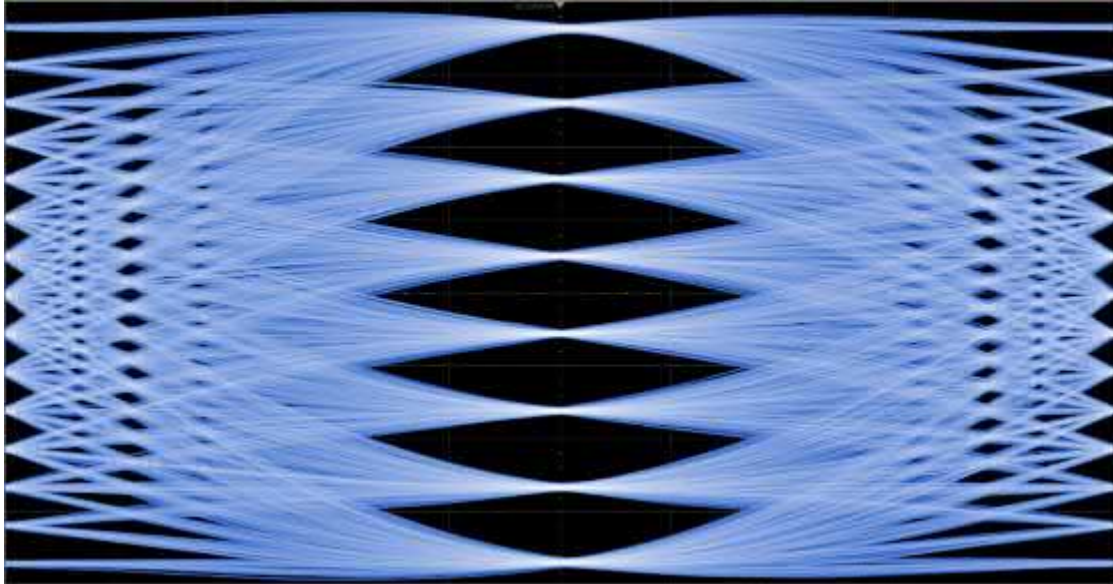

Figure 73 – 10 m - PAM 8 - 0.84 GBd - abscissa: 119 ps/div - ordinate: 170 mV

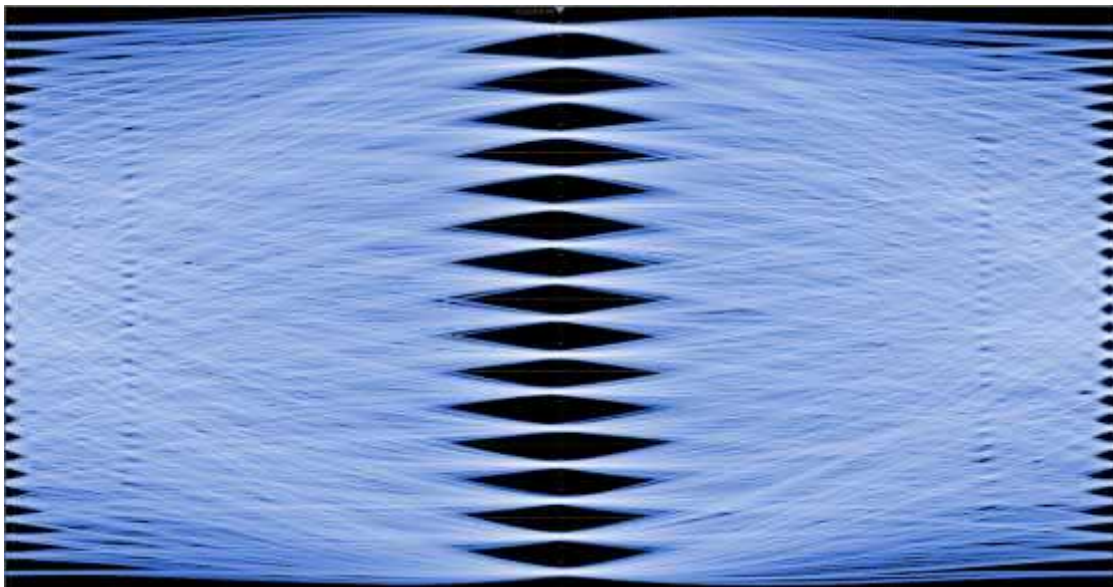

Figure 74 – 10 m - PAM 16 - 0.63 GBd - abscissa: 159 ps/div - ordinate: 180 mV

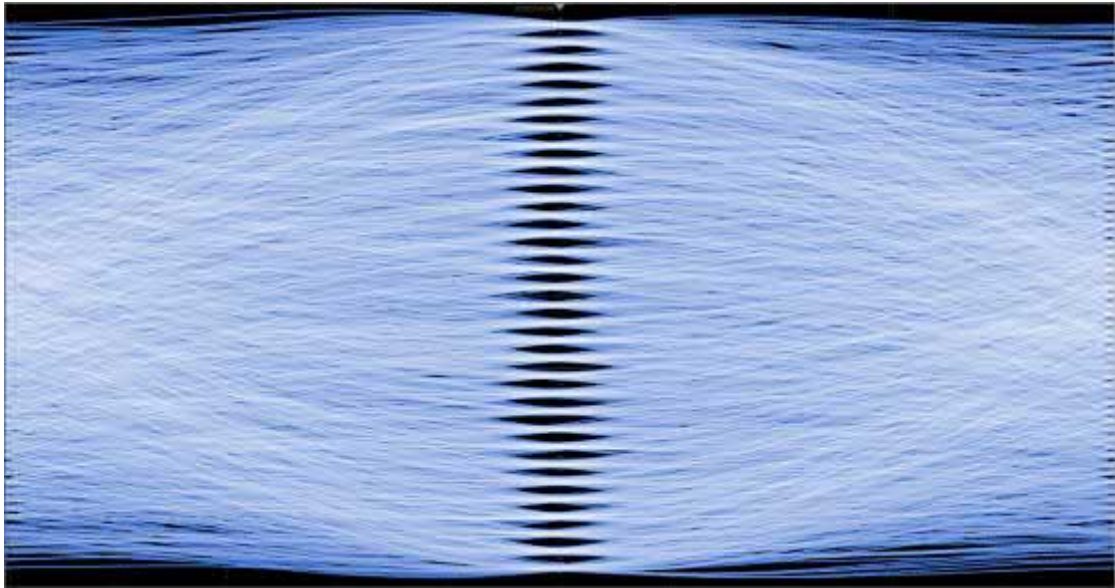

Figure 75 – 10 m - PAM32 - 0.50 GBd - abscissa: 200 ps/div - ordinate: 190 mV

8.5.2 Transmission of 20 GBit/s over 10 m

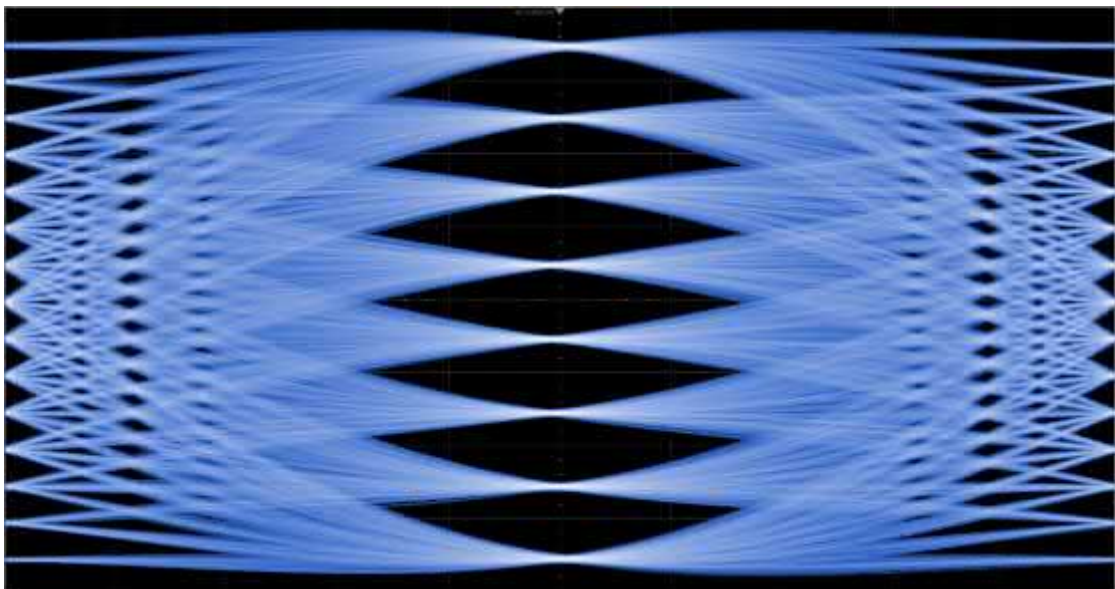

Figure 76 – 10 m - PAM8 - 1.67 GBd - abscissa: 60 ps/div - ordinate: 140 mV

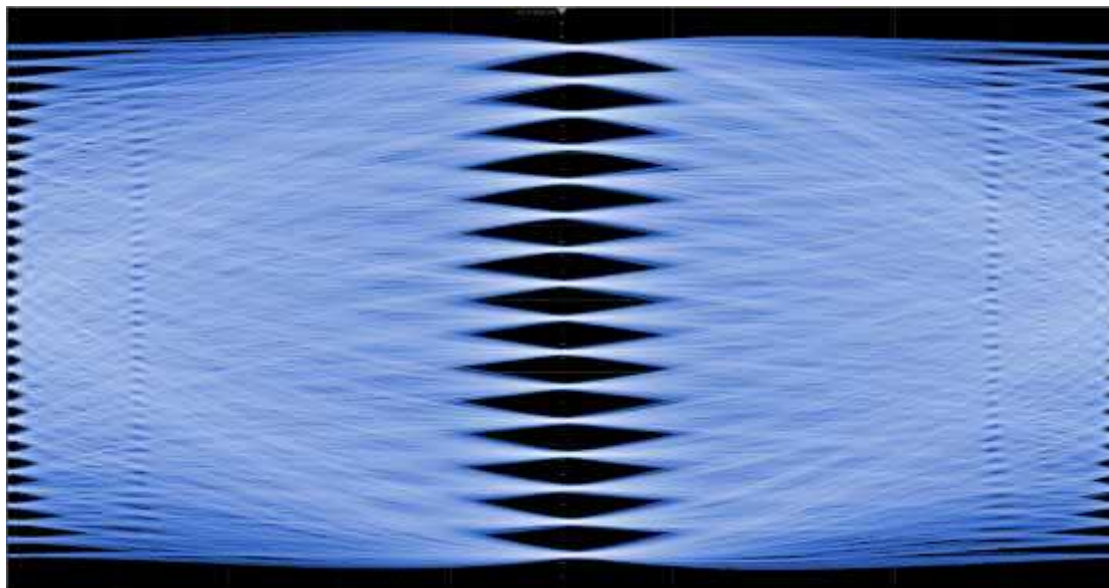

Figure 77 – 10 m - PAM 16 - 1.25 GBd - abscissa: 80 ps/div - ordinate: 160 mV

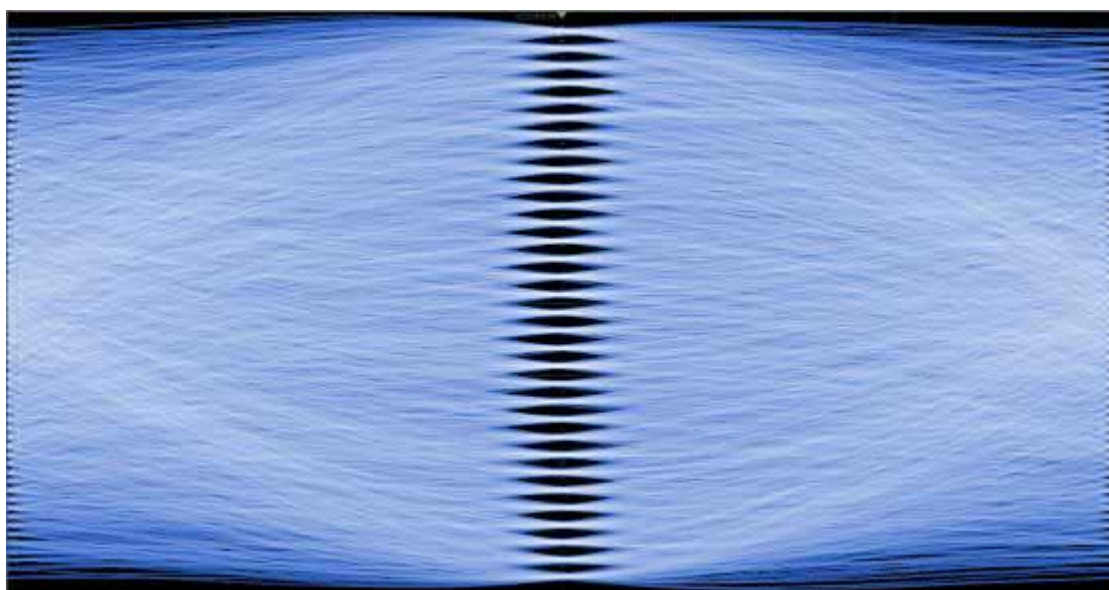

Figure 78 – 10 m - PAM 32 - 1.00 GBd - abscissa: 100 ps/div - ordinate: 160 mV

8.5.3 Transmission of 30 GBit/s over 10 m

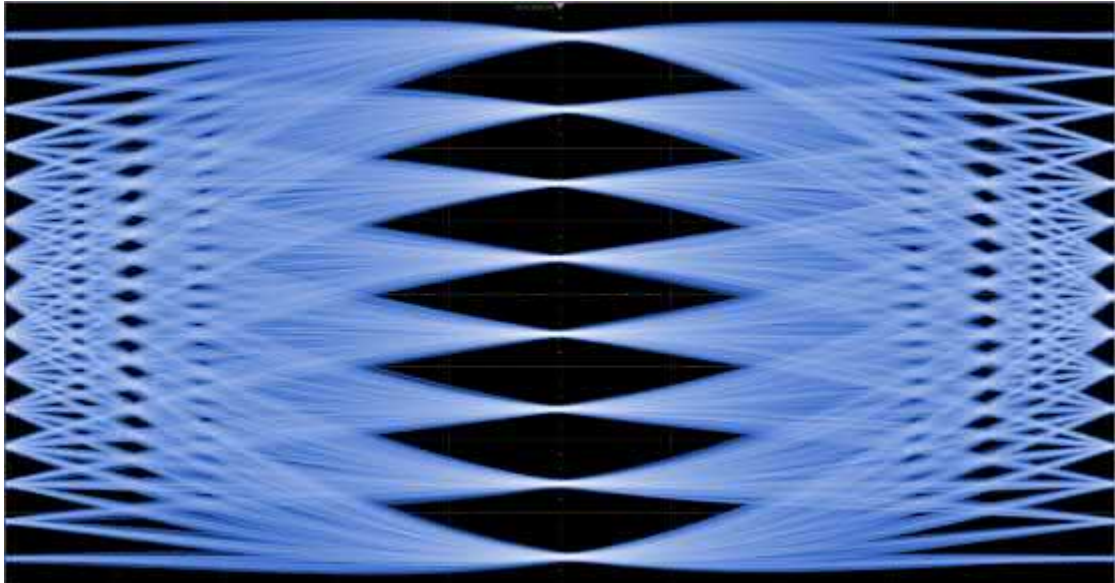

Figure 79 – 10 m - PAM 8 - 2.50 GBd - abscissa: 40 ps/div - ordinate: 120 mV

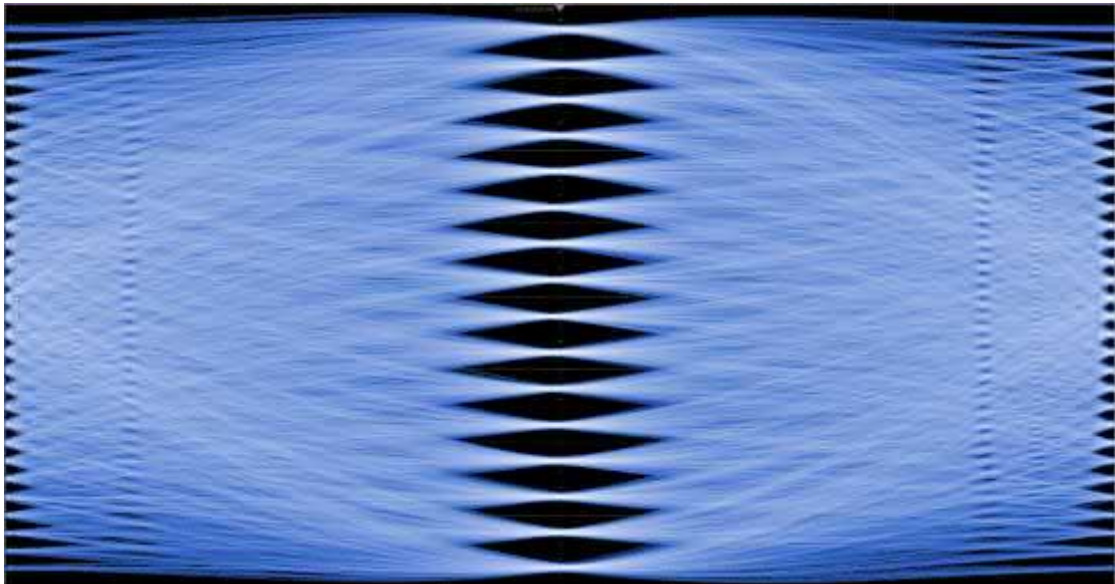

Figure 80 – 10 m - PAM 16 - 1.88 GBd - abscissa: 53 ps/div - ordinate: 130 mV

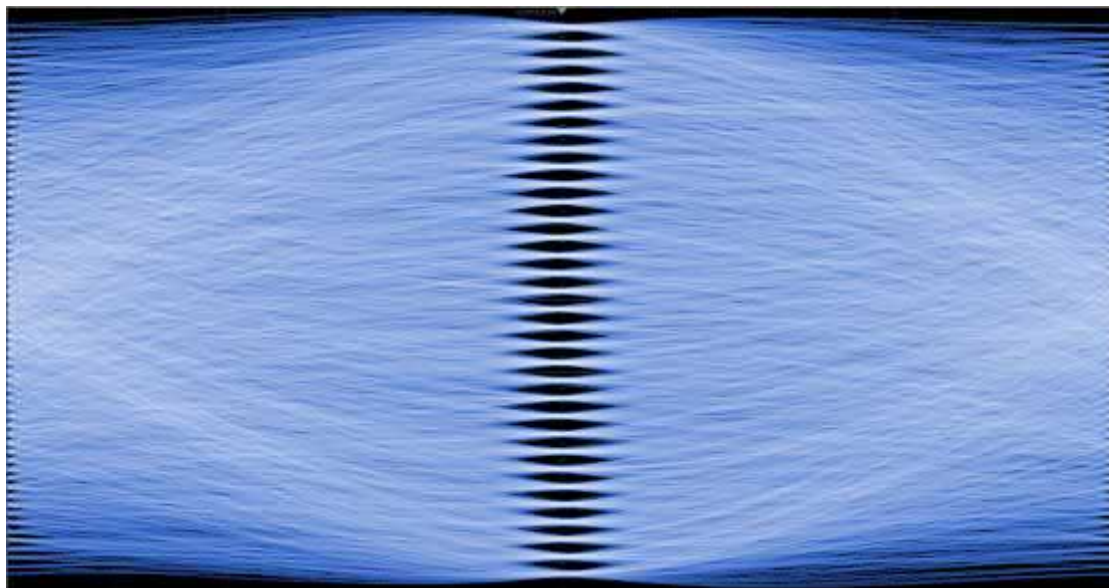

Figure 81 – 10 m - PAM32 - 1.50 GBd - abscissa: 67 ps/div - ordinate: 140 mV

8.5.4 Transmission of 40 GBit/s over 10 m

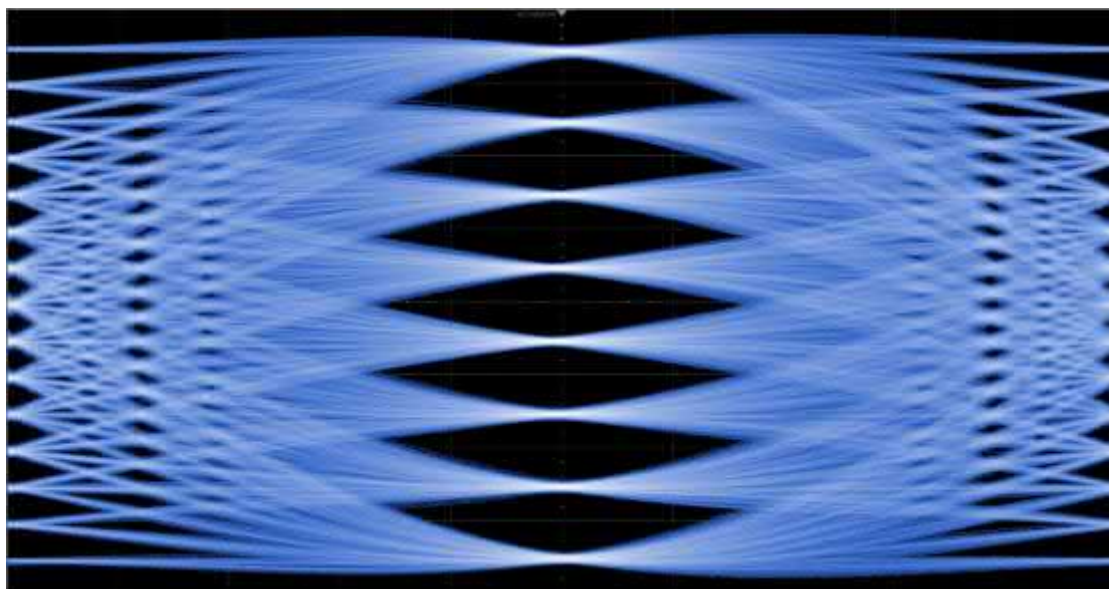

Figure 82 – 10 m - PAM8 - 3.34 GBd - abscissa: 30 ps/div - ordinate: 100 mV

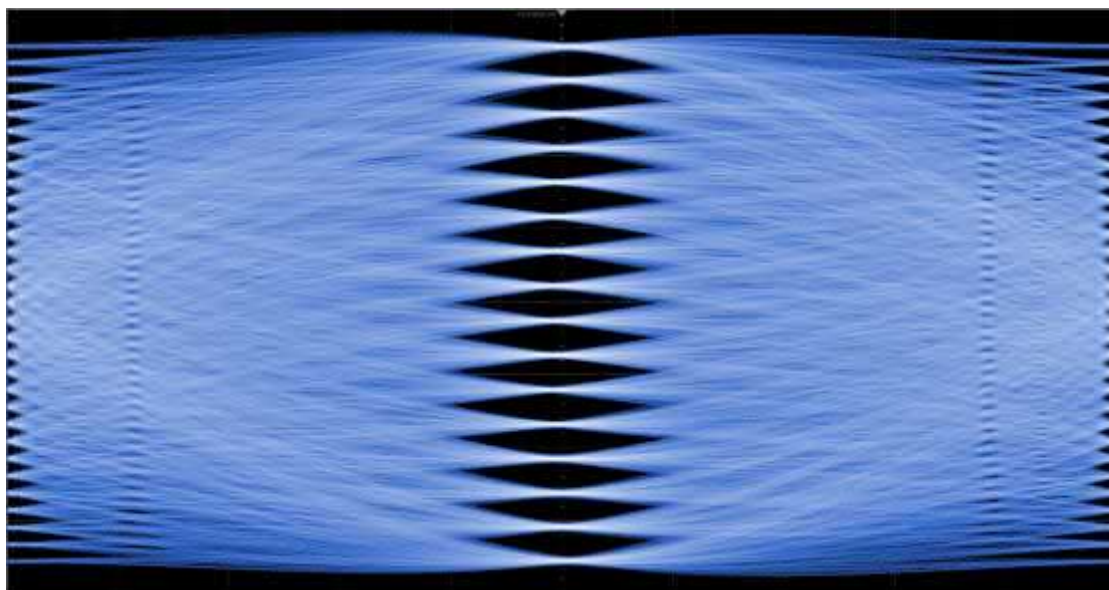

Figure 83 – 10 m - PAM 16 - 2.50 GBd - abscissa: 40 ps/div - ordinate: 120 mV

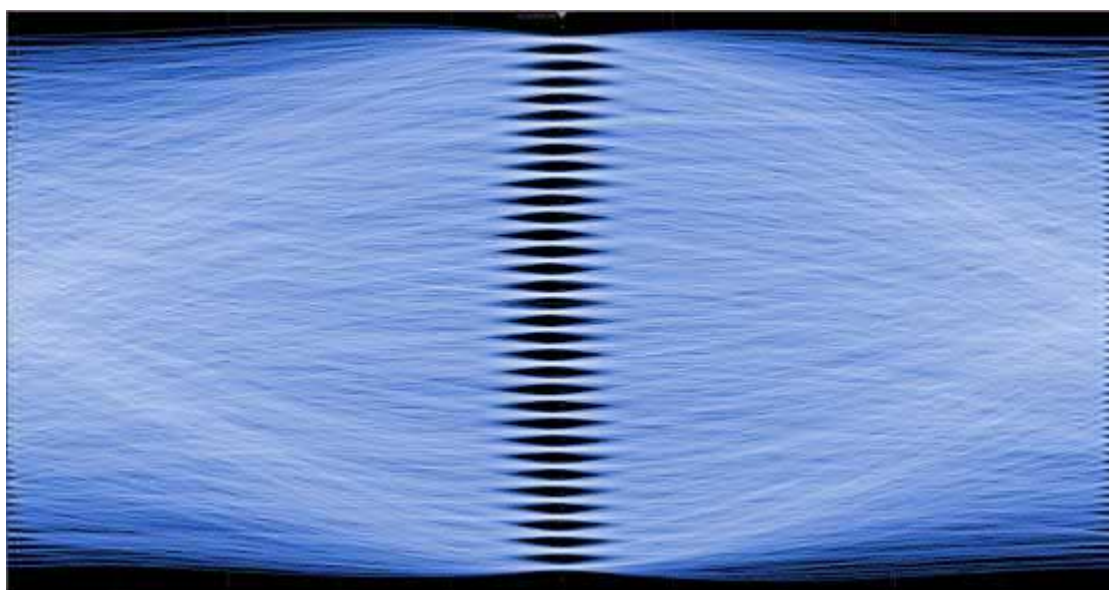

Figure 84 – 10 m - PAM 32 - 2.00 GBd - abscissa: 50 ps/div - ordinate: 130 mV

8.5.5 Transmission of 50 GBit/s over 10 m

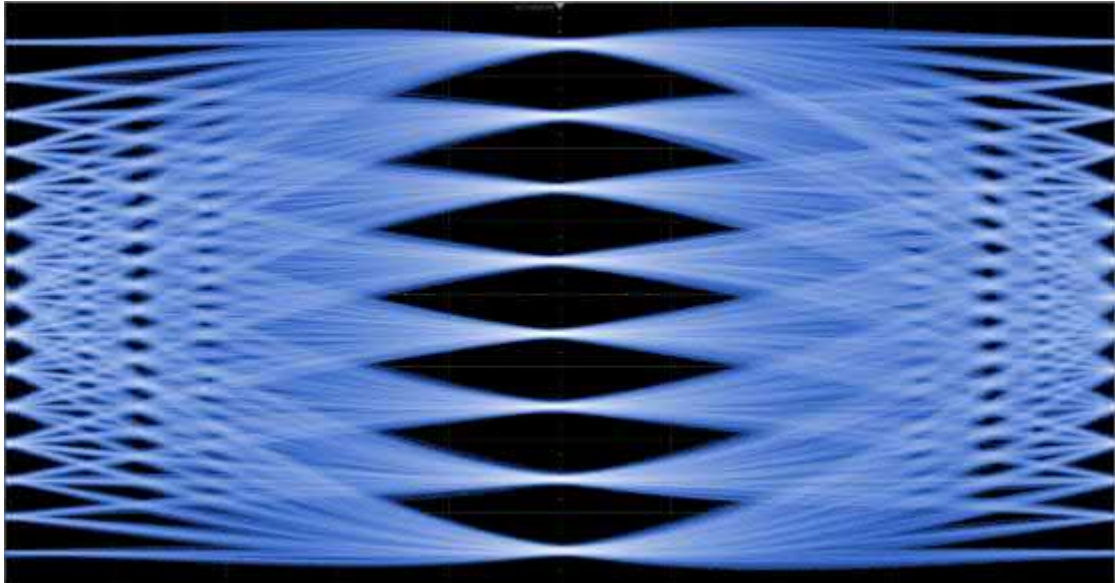

Figure 85 – 10 m - PAM 8 - 4.17 GBd - abscissa: 24 ps/div - ordinate: 88 mV

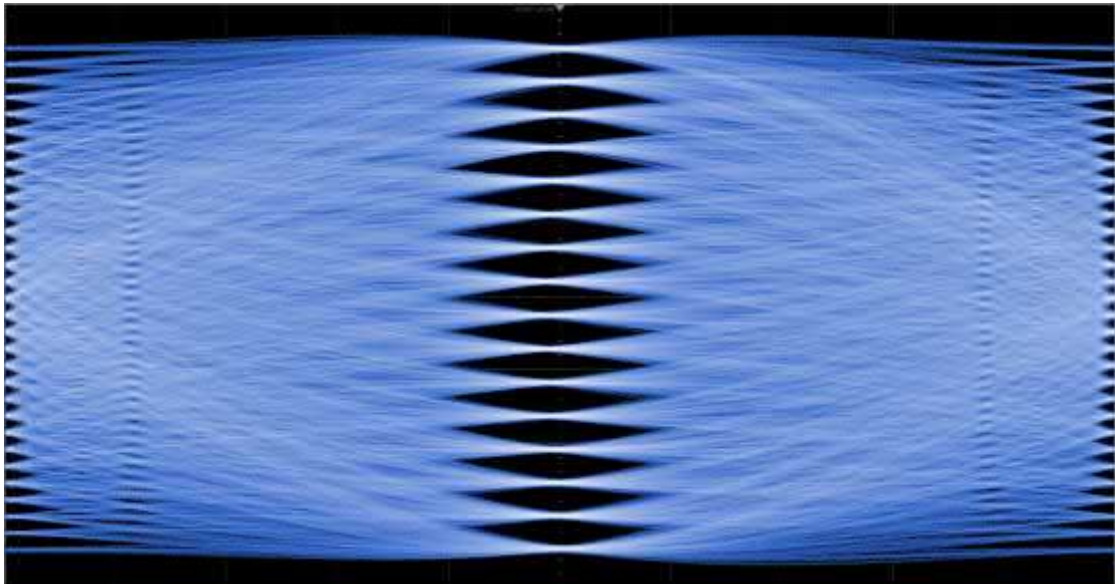

Figure 86 – 10 m - PAM 16 - 3.13 GBd - abscissa: 32 ps/div - ordinate: 110 mV

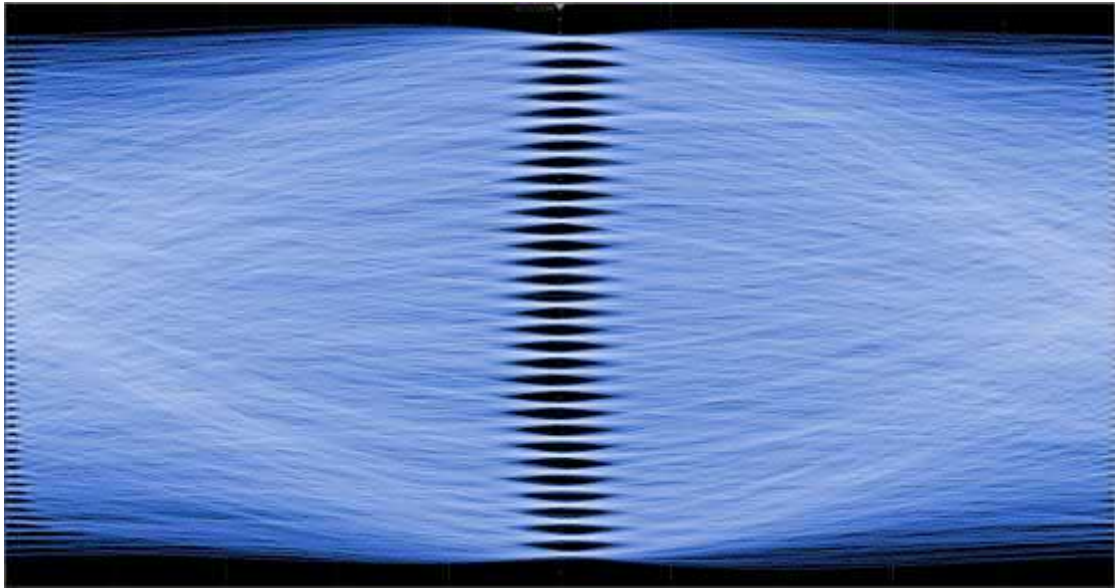

Figure 87 – 10 m - PAM32 - 2.50 GBd - abscissa: 40 ps/div - ordinate: 120 mV

8.5.6 Transmission of 60 GBit/s over 10 m

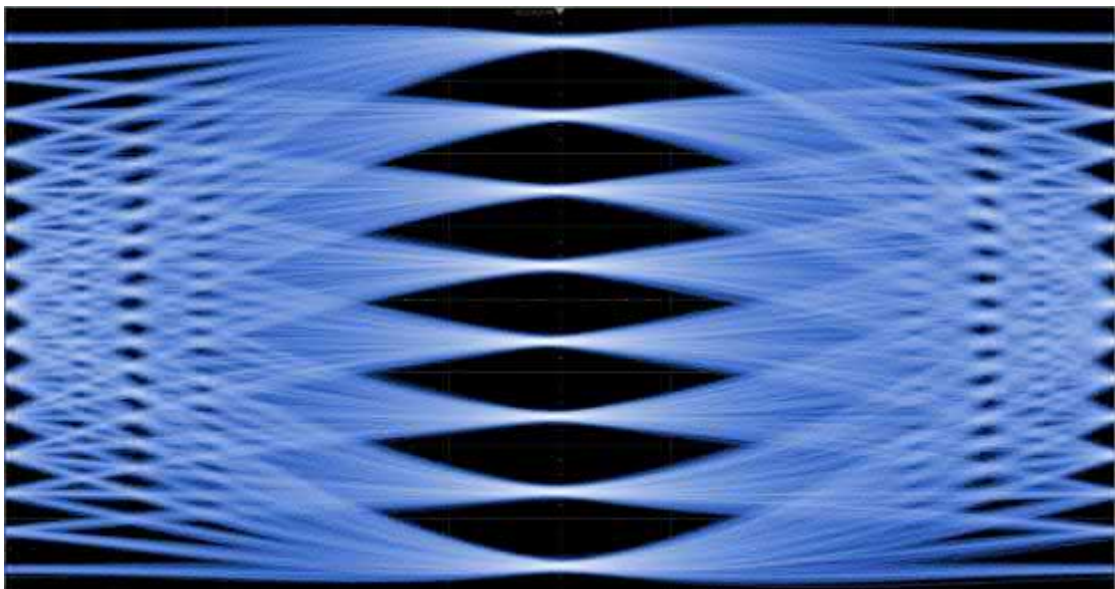

Figure 88 – 10 m - PAM8 - 5.00 GBd - abscissa: 20 ps/div - ordinate: 72 mV

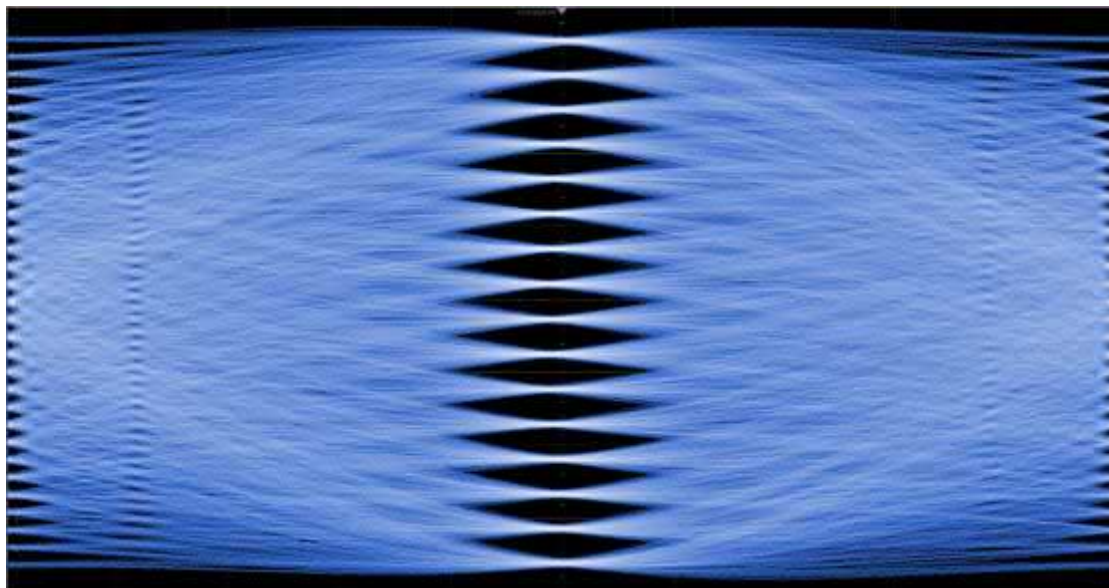

Figure 89 – 10 m - PAM 16 - 3.75 GBd - abscissa: 27 ps/div - ordinate: 94 mV

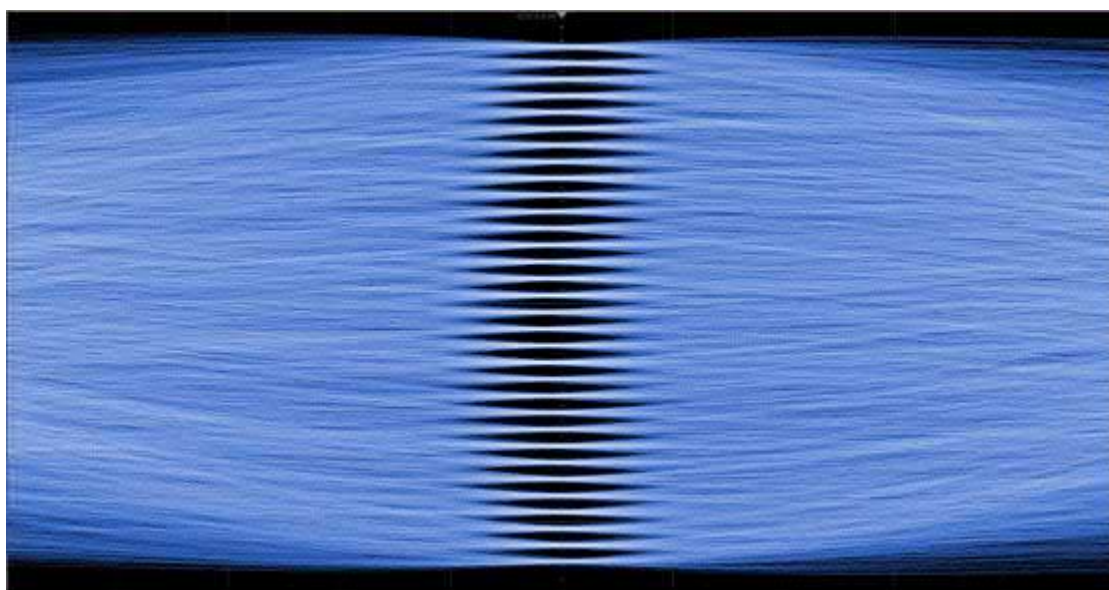

Figure 90 – 10 m - PAM 32 - 3.00 GBd - abscissa: 33 ps/div - ordinate: 110 mV

8.5.7 Transmission of 70 GBit/s over 10 m

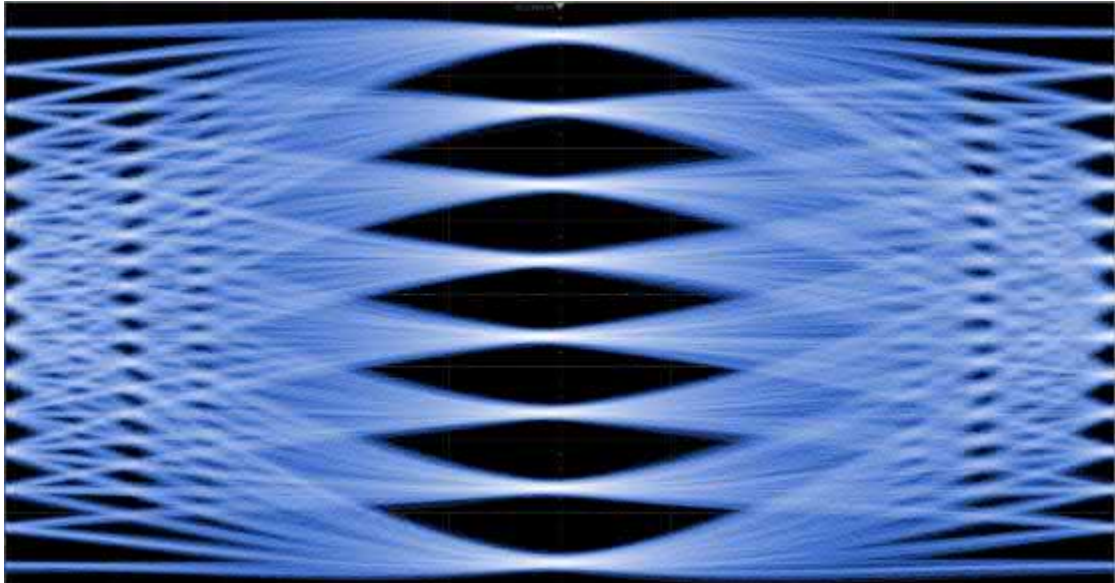

Figure 91 – 10 m - PAM 8 - 5.84 GBd - abscissa: 17 ps/div - ordinate: 62 mV

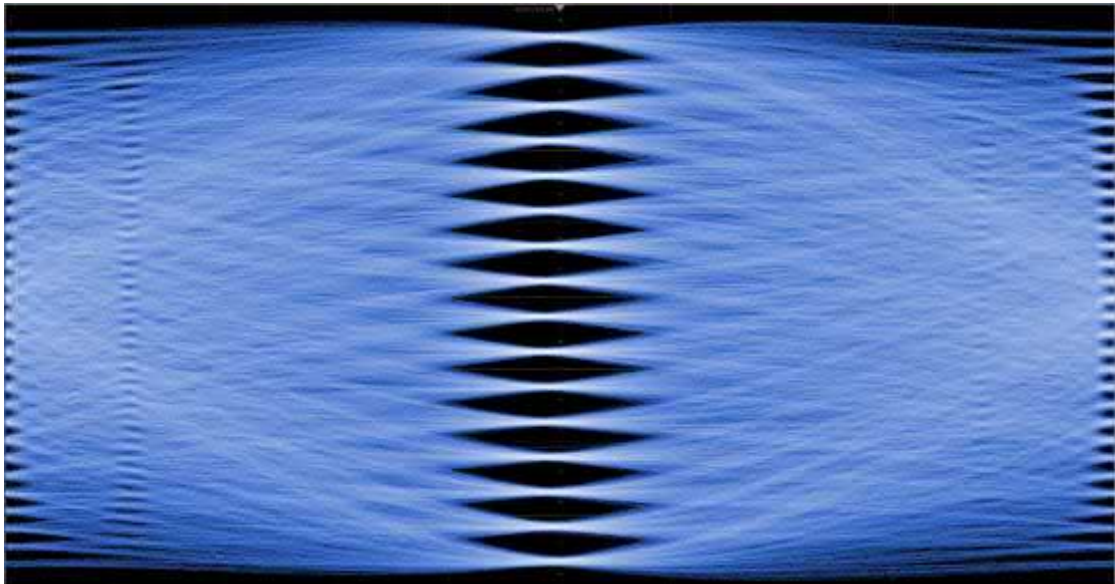

Figure 92 – 10 m - PAM 16 - 4.38 GBd - abscissa: 23 ps/div - ordinate: 84 mV

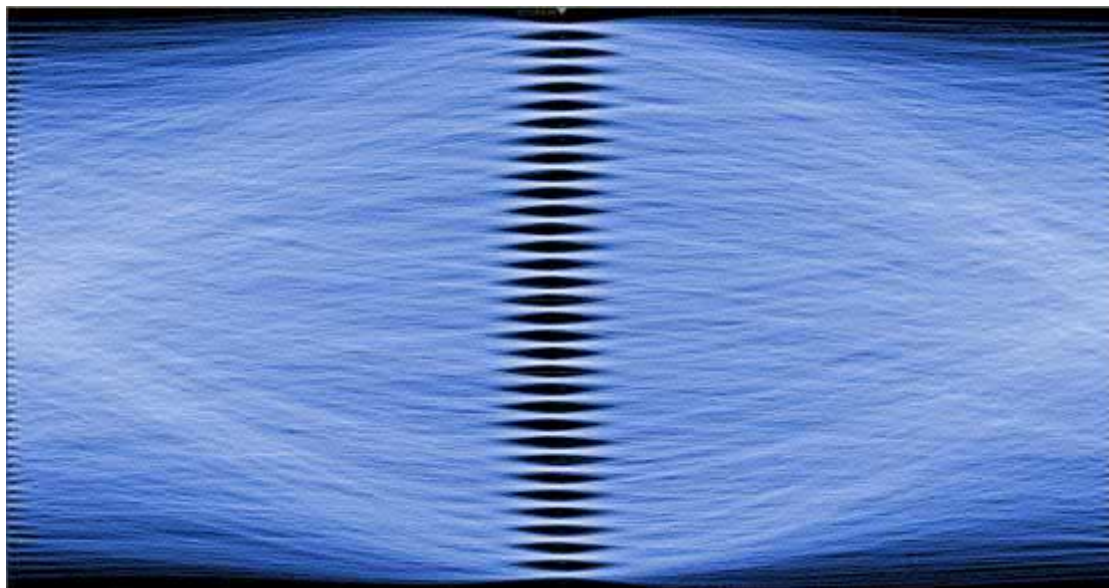

Figure 93 – 10 m - PAM 32 - 3.50 GBd - abscissa: 29 ps/div - ordinate: 94 mV

8.5.8 Transmission of 80 GBit/s over 10 m

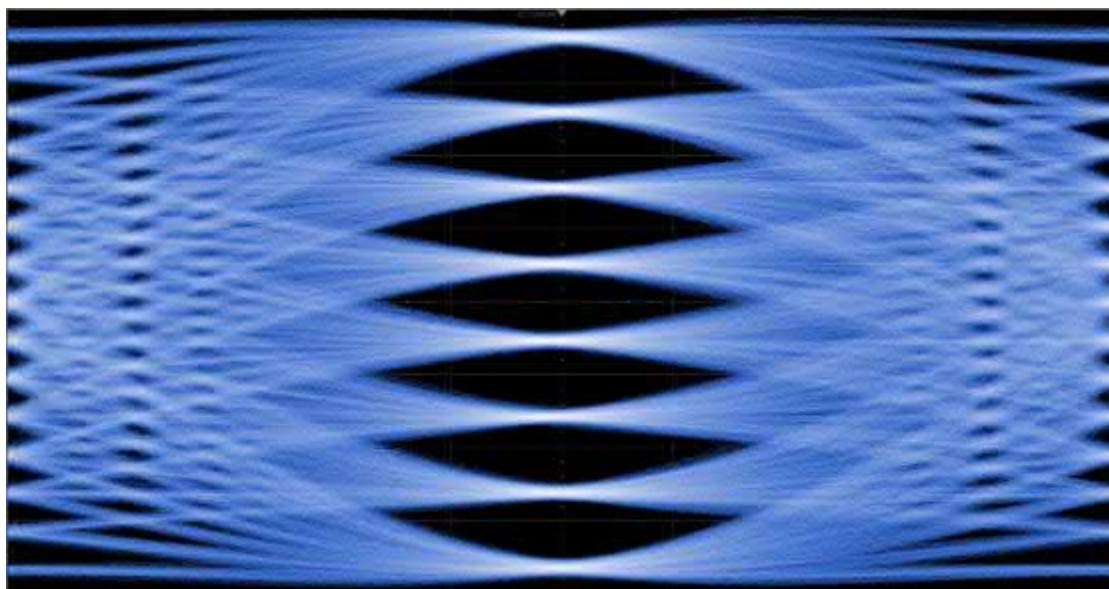

Figure 94 – 10 m - PAM 8 - 6.67 GBd - abscissa: 15 ps/div - ordinate: 52 mV

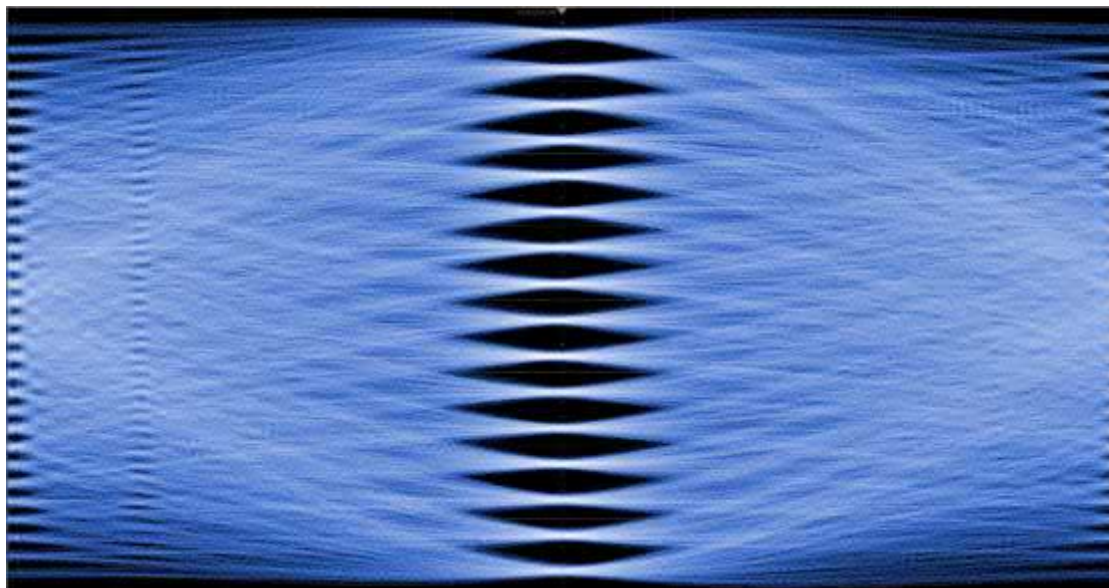

Figure 95 – 10 m - PAM 16 - 5.00 GBd - abscissa: 20 ps/div - ordinate: 72 mV

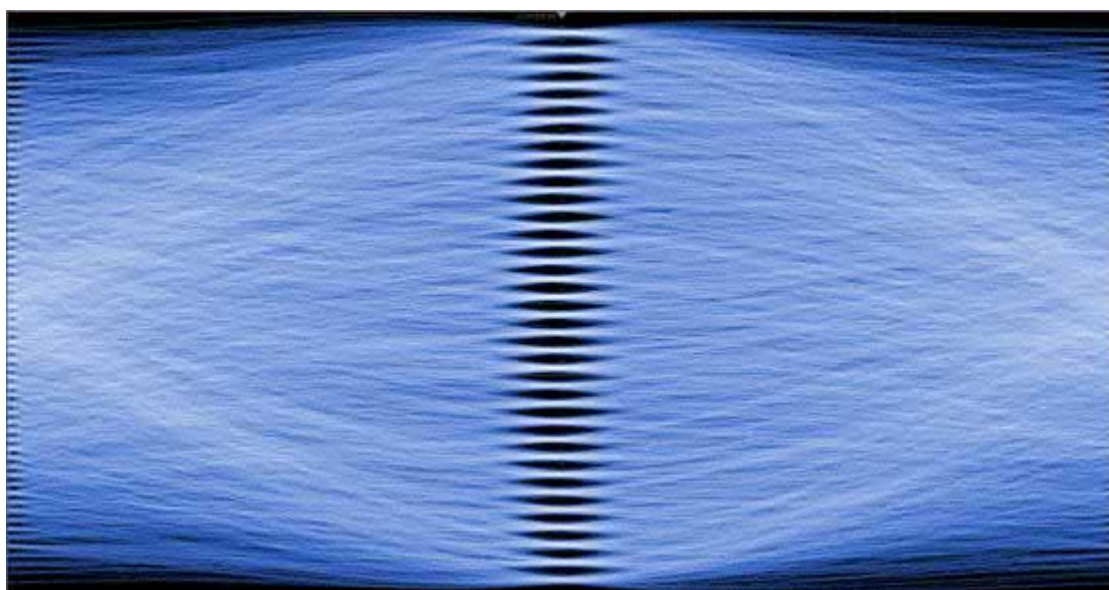

Figure 96 – 10 m - PAM 32 - 4.00 GBd - abscissa: 25 ps/div - ordinate: 88 mV

8.5.9 Transmission of 90 GBit/s over 10 m

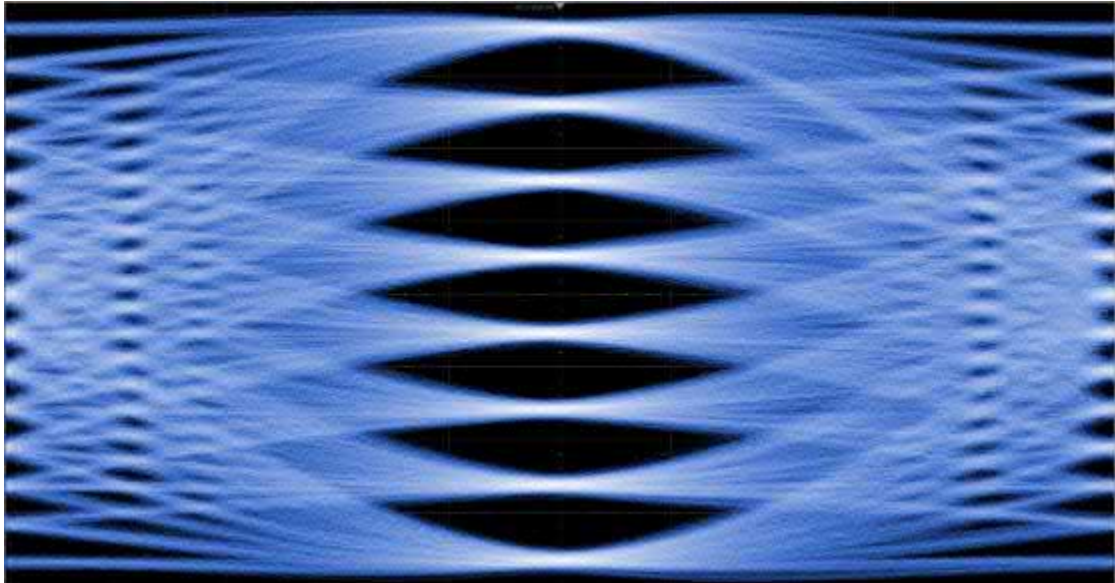

Figure 97 – 10 m - PAM 8 - 7.50 GBd - abscissa: 13 ps/div - ordinate: 46 mV

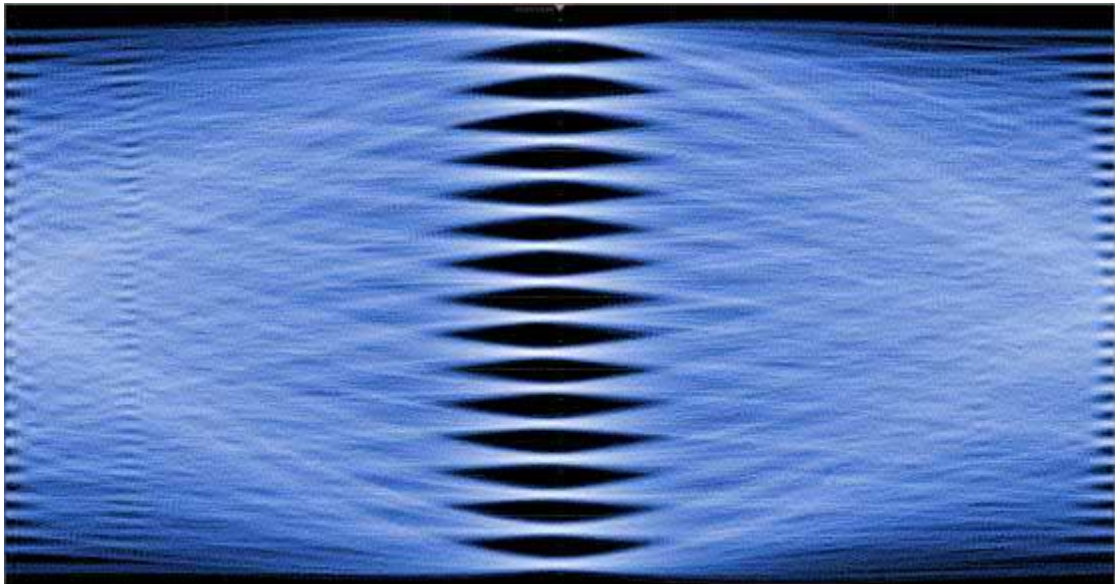

Figure 98 – 10 m - PAM 16 - 5.63 GBd - abscissa: 18 ps/div - ordinate: 64 mV

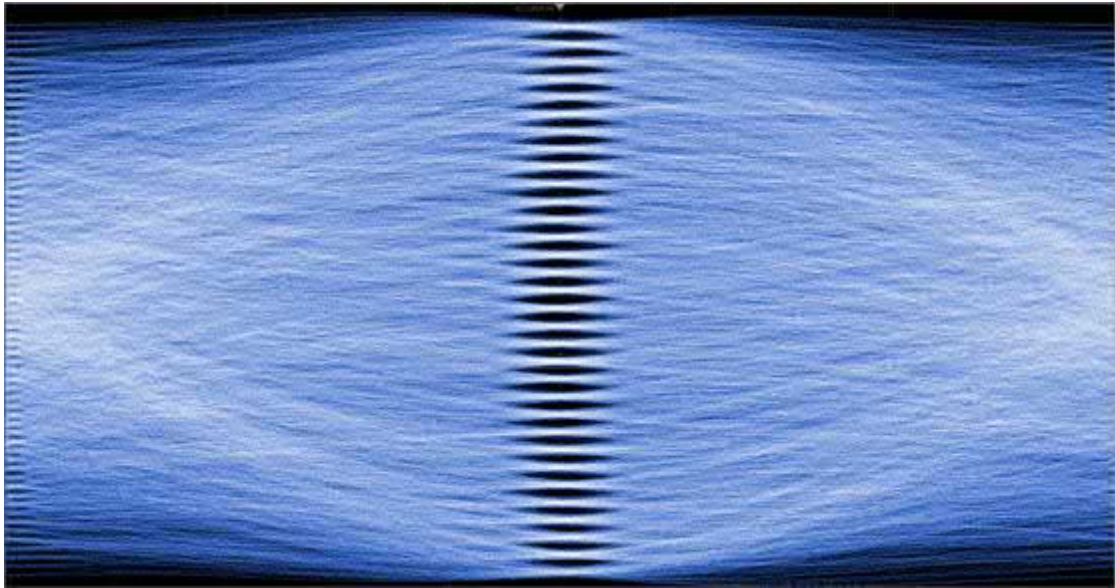

Figure 99 – 10 m - PAM 32 - 4.50 GBd - abscissa: 22 ps/div - ordinate: 80 mV

8.5.10 Transmission of 100 GBit/s over 10 m

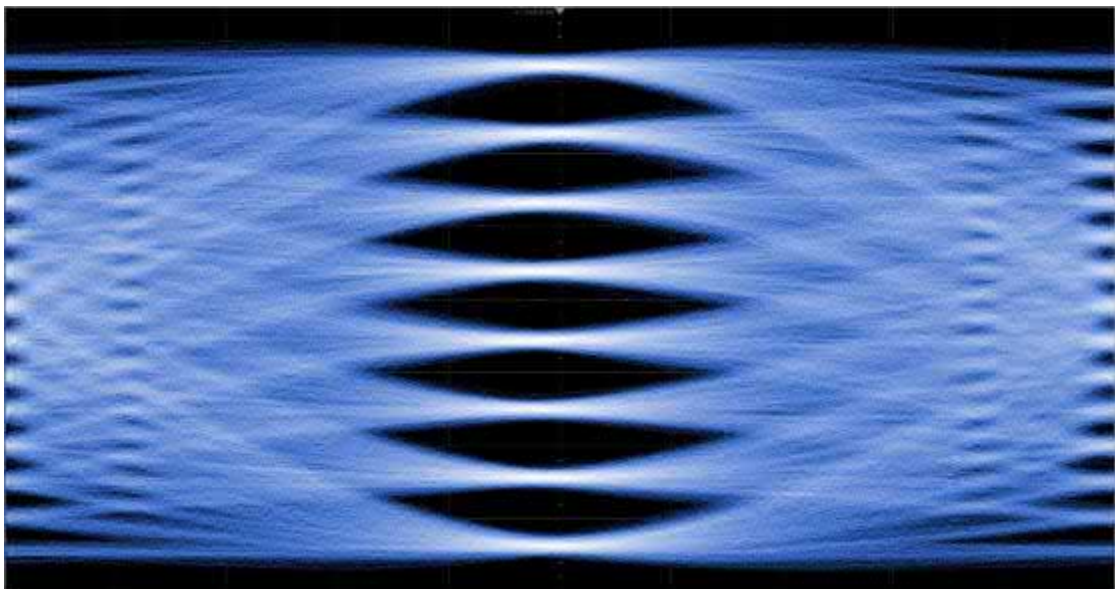

Figure 100 – 10 m - PAM 8 - 8.34 GBd - abscissa: 12 ps/div - ordinate: 46 mV

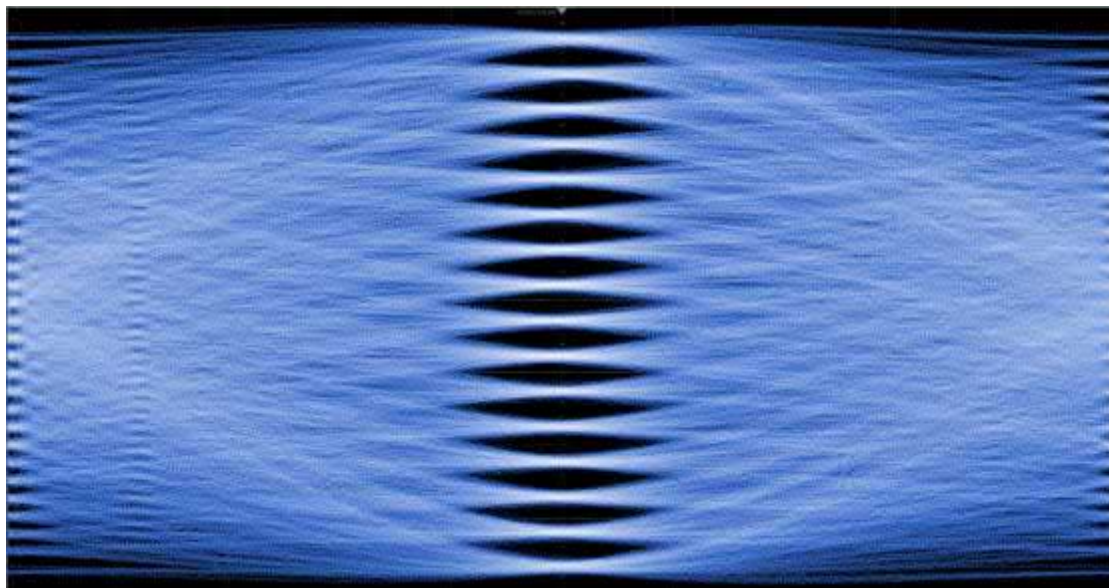

Figure 101 – 10 m - PAM 16 - 6.25 GBd - abscissa: 16 ps/div - ordinate: 58 mV

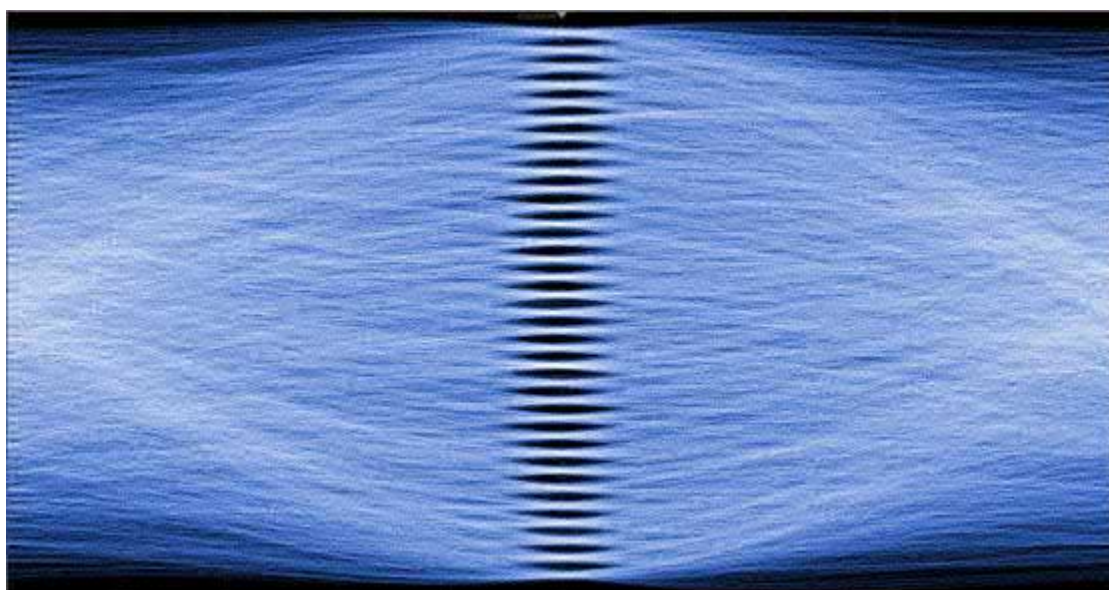

Figure 102 – 10 m - PAM 32 - 5.00 GBd - abscissa: 20 ps/div - ordinate: 72 mV

8.6 Transmission over 30 m

8.6.1 Transmission of 10 GBit/s over 30 m

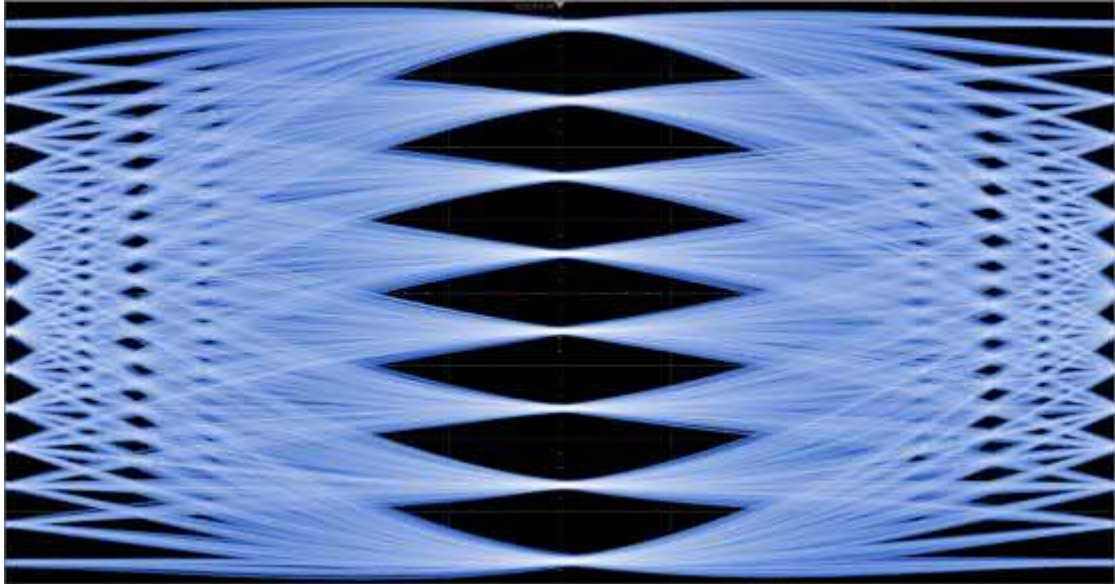

Figure 103 – 30 m - PAM 8 - 0.84 GBd - abscissa: 119 ps/div - ordinate: 170 mV

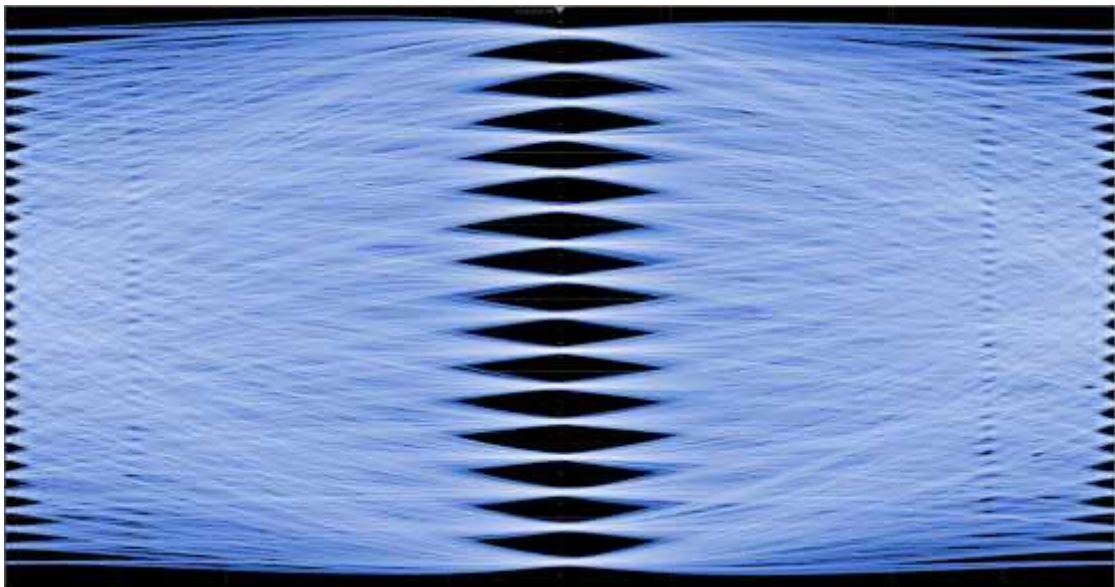

Figure 104 – 30 m - PAM 16 - 0.63 GBd - abscissa: 159 ps/div - ordinate: 180 mV

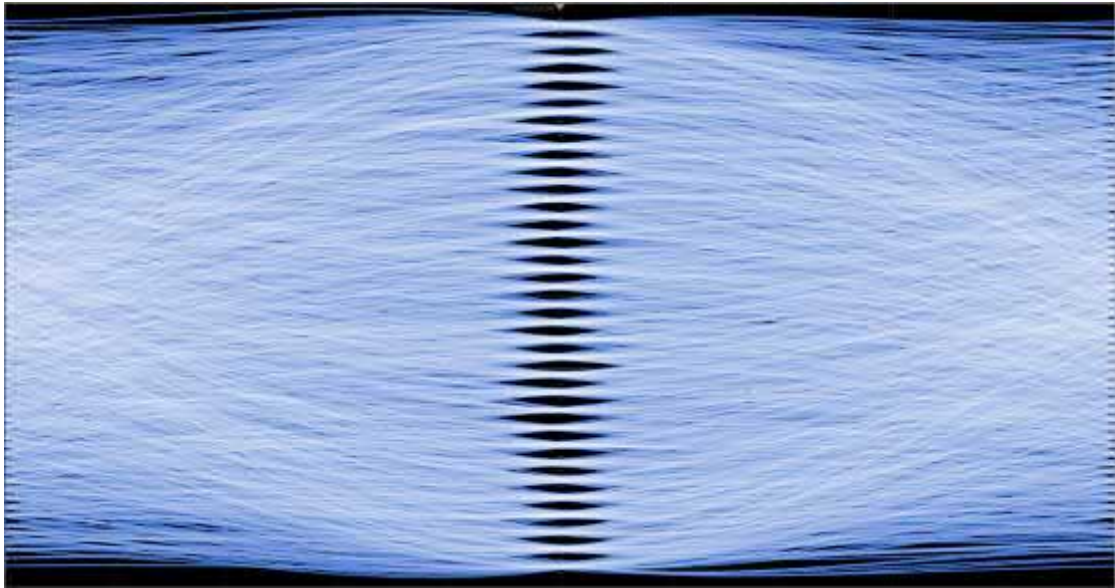

Figure 105 – 30 m - PAM32 - 0.50 GBd - abscissa: 200 ps/div - ordinate: 190 mV

8.6.2 Transmission of 20 GBit/s over 30 m

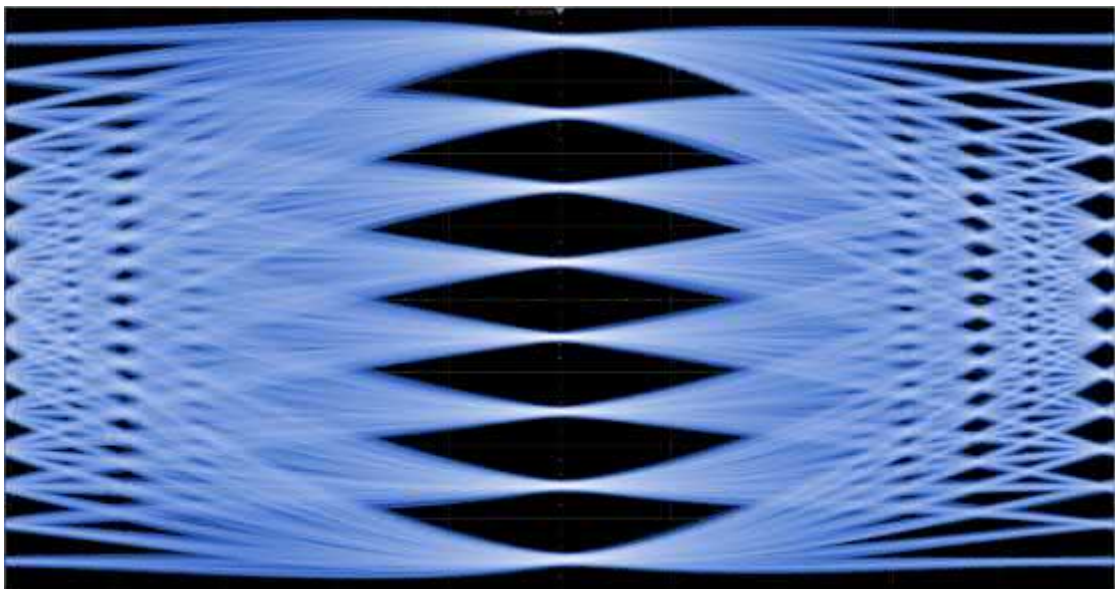

Figure 106 – 30 m - PAM 8 - 1.67 GBd - abscissa: 60 ps/div - ordinate: 140 mV

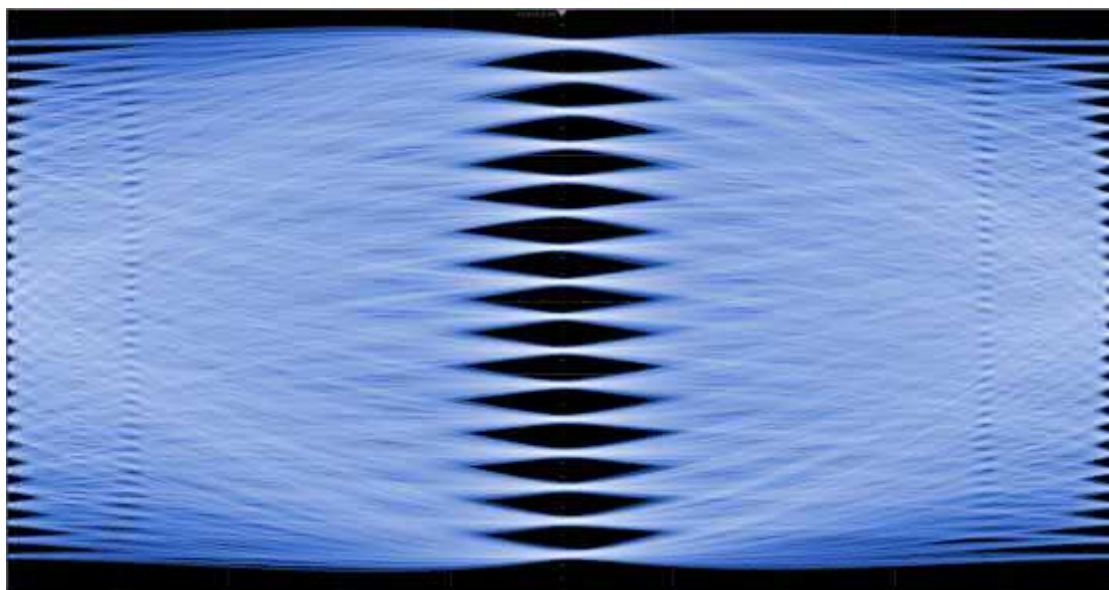

Figure 107 – 30 m - PAM 16 - 1.25 GBd - abscissa: 80 ps/div - ordinate: 160 mV

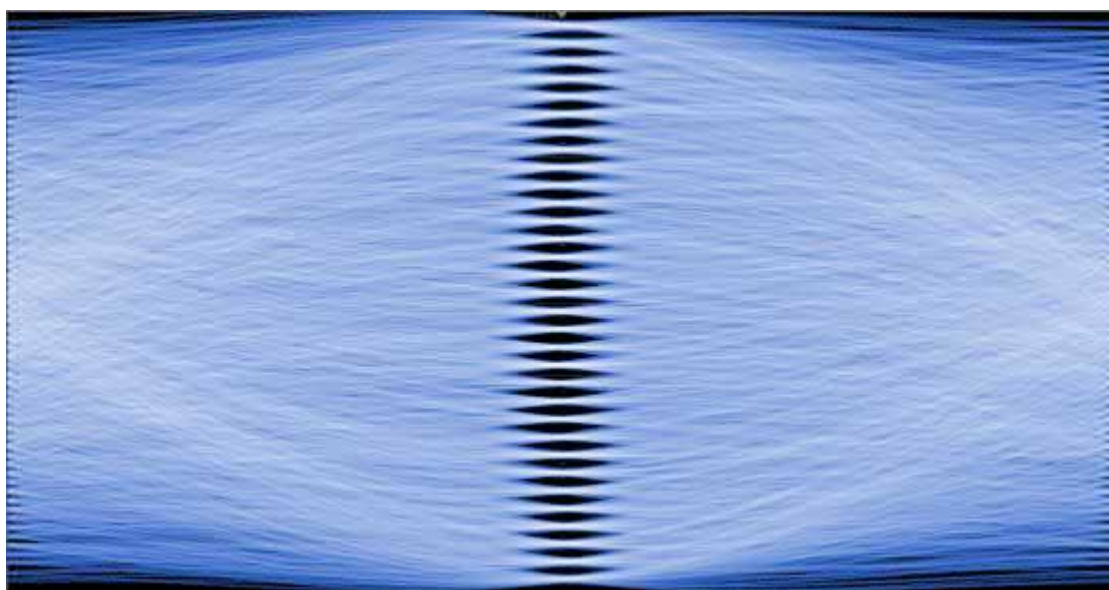

Figure 108 – 30 m - PAM 32 - 1.00 GBd - abscissa: 100 ps/div - ordinate: 160 mV

8.6.3 Transmission of 30 GBit/s over 30 m

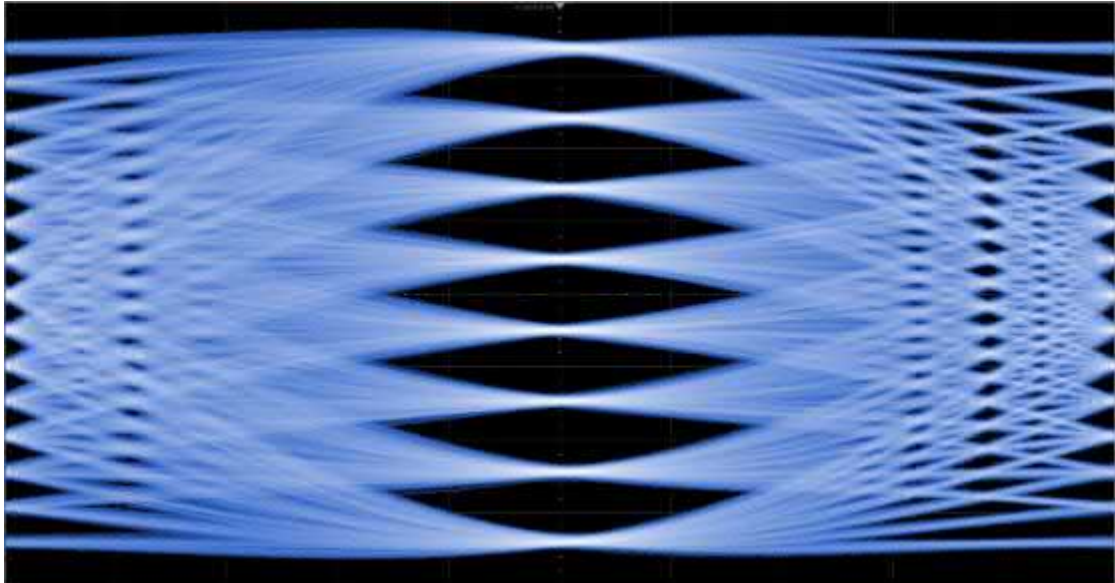

Figure 109 – 30 m - PAM 8 - 2.50 GBd - abscissa: 40 ps/div - ordinate: 120 mV

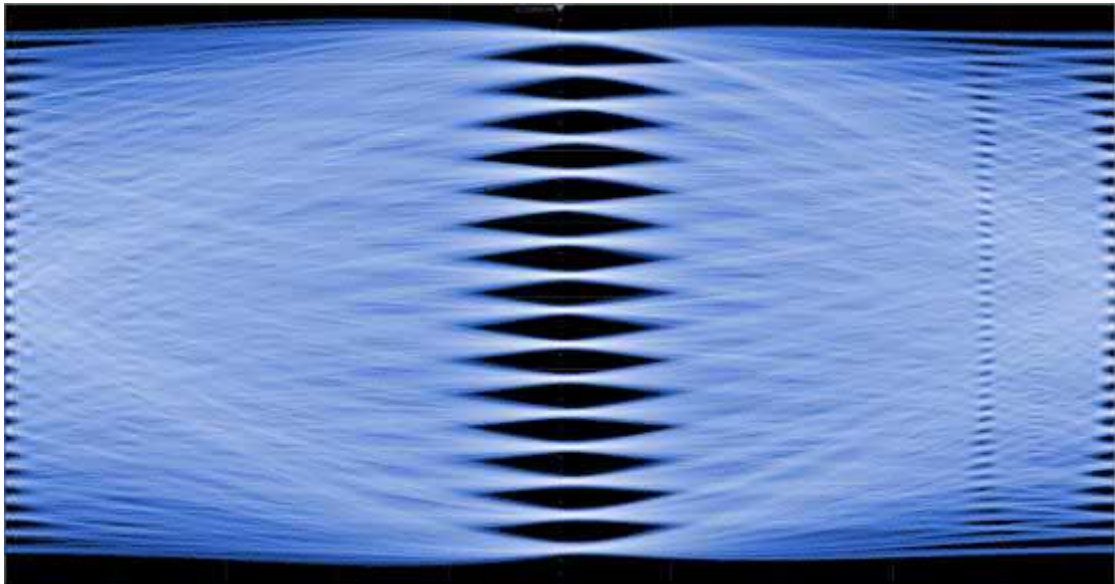

Figure 110 – 30 m - PAM 16 - 1.88 GBd - abscissa: 53 ps/div - ordinate: 130 mV

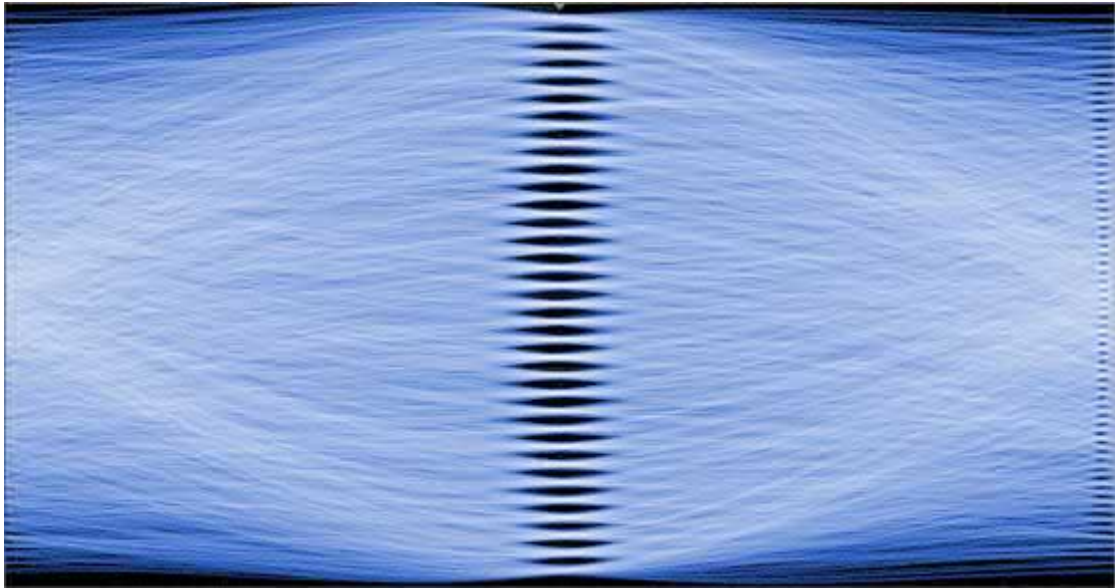

Figure 111 – 30 m - PAM 32 - 1.50 GBd - abscissa: 67 ps/div - ordinate: 140 mV

8.6.4 Transmission of 40 GBit/s over 30 m

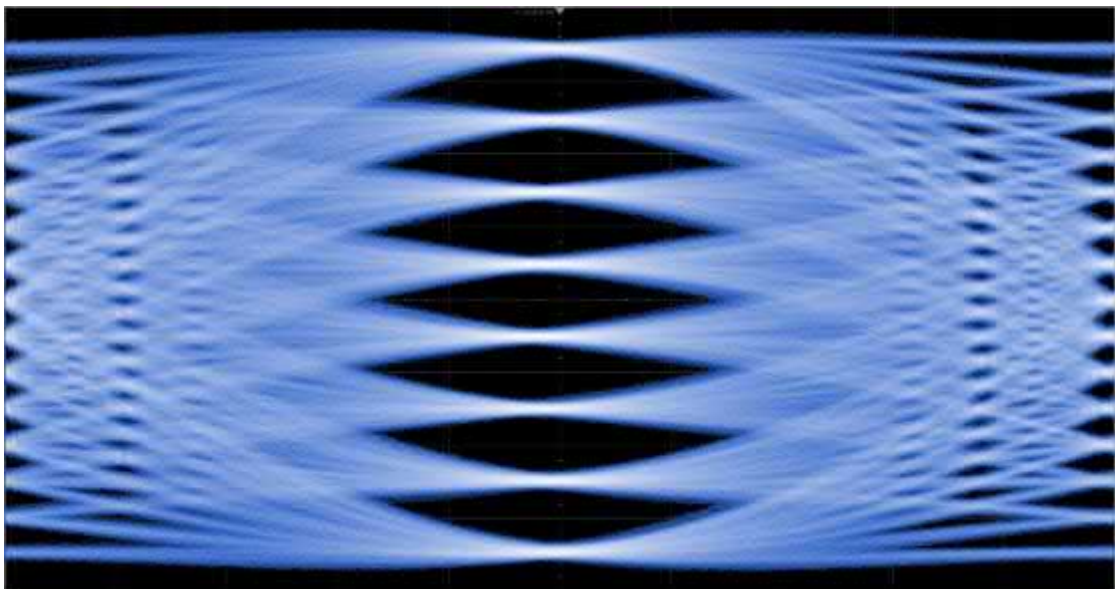

Figure 112 – 30 m - PAM 8 - 3.34 GBd - abscissa: 30 ps/div - ordinate: 100 mV

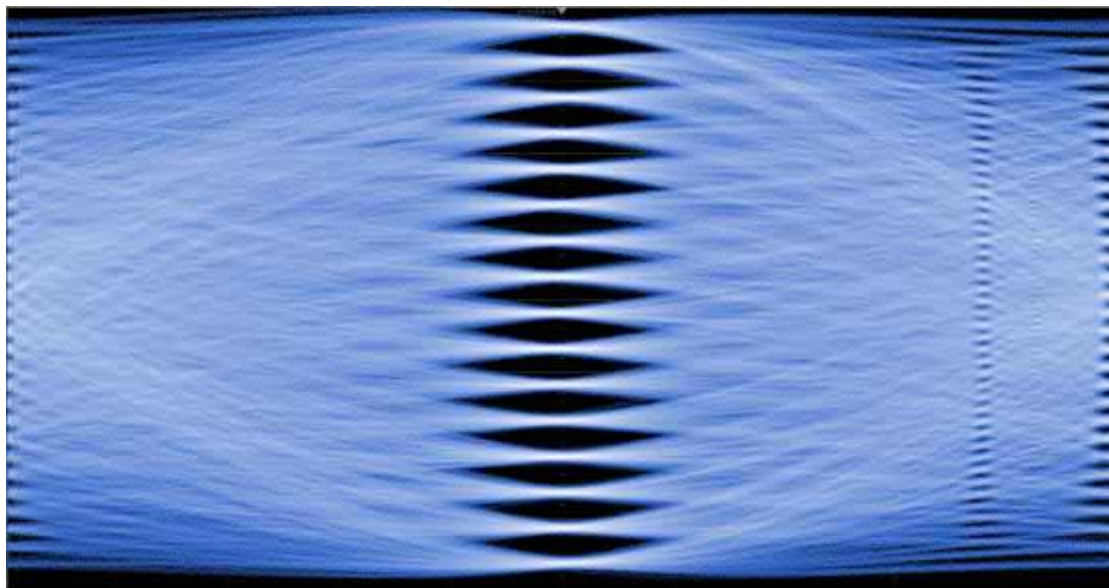

Figure 113 – 30 m - PAM 16 - 2.50 GBd - abscissa: 40 ps/div - ordinate: 120 mV

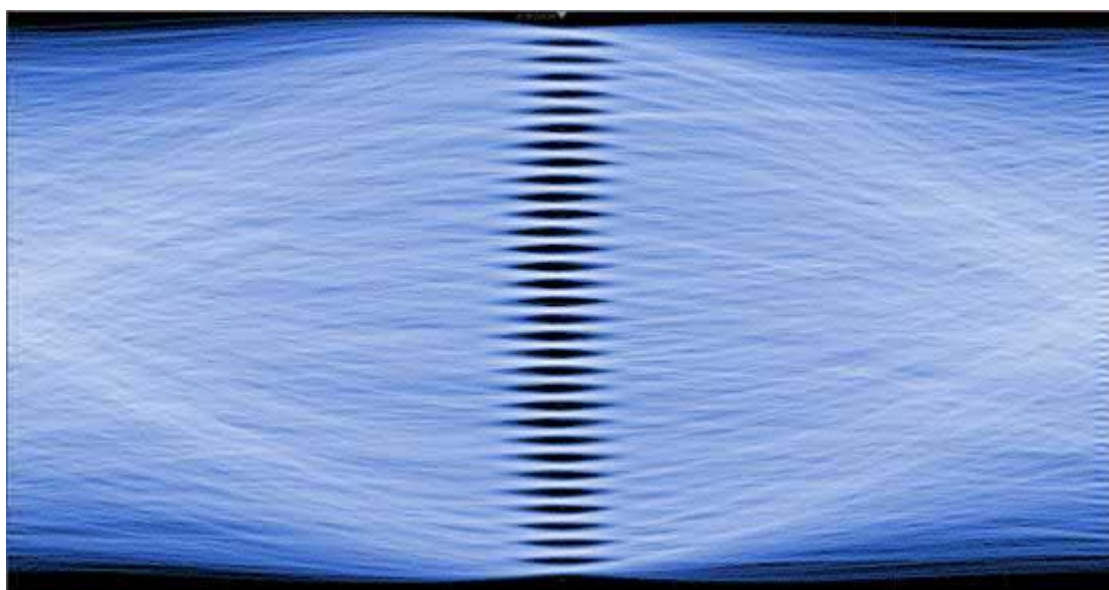

Figure 114 – 30 m - PAM 32 - 2.00 GBd - abscissa: 50 ps/div - ordinate: 130 mV

8.6.5 Transmission of 50 GBit/s over 30 m

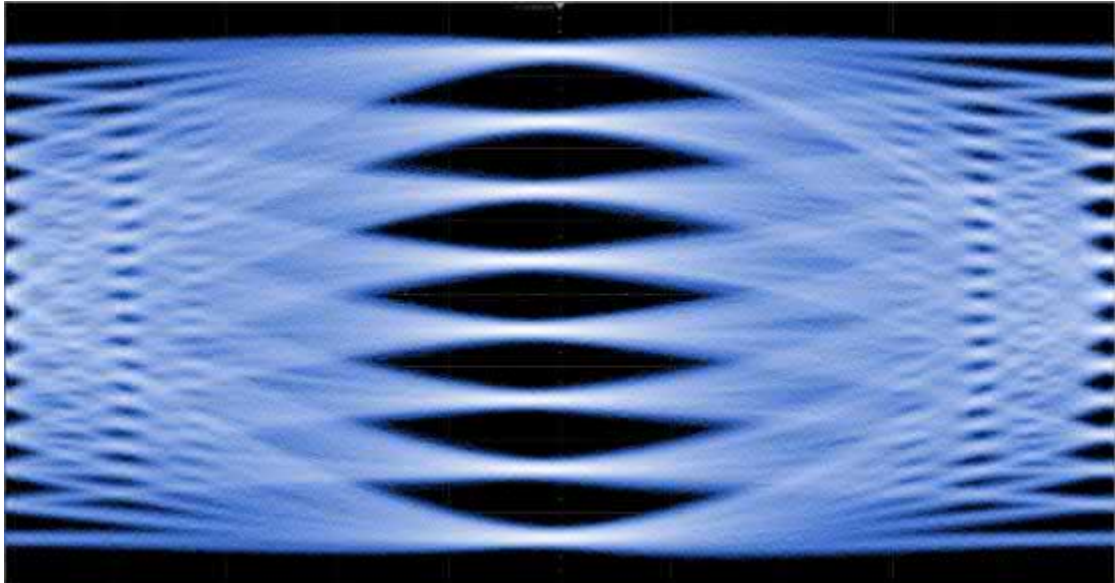

Figure 115 – 30 m - PAM 8 - 4.17 GBd - abscissa: 24 ps/div - ordinate: 88 mV

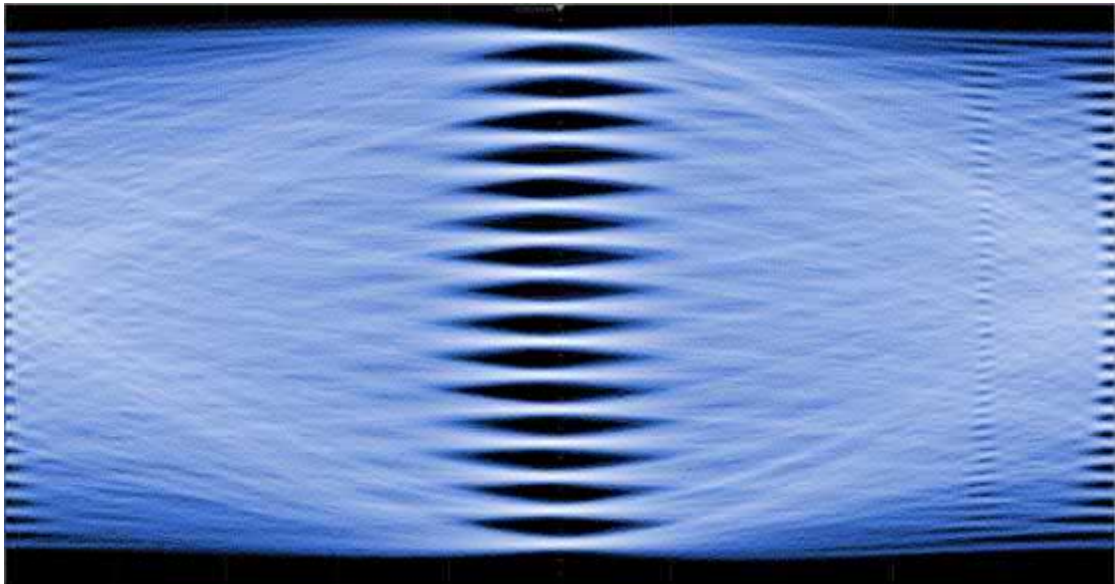

Figure 116 – 30 m - PAM 16 - 3.13 GBd - abscissa: 32 ps/div - ordinate: 110 mV

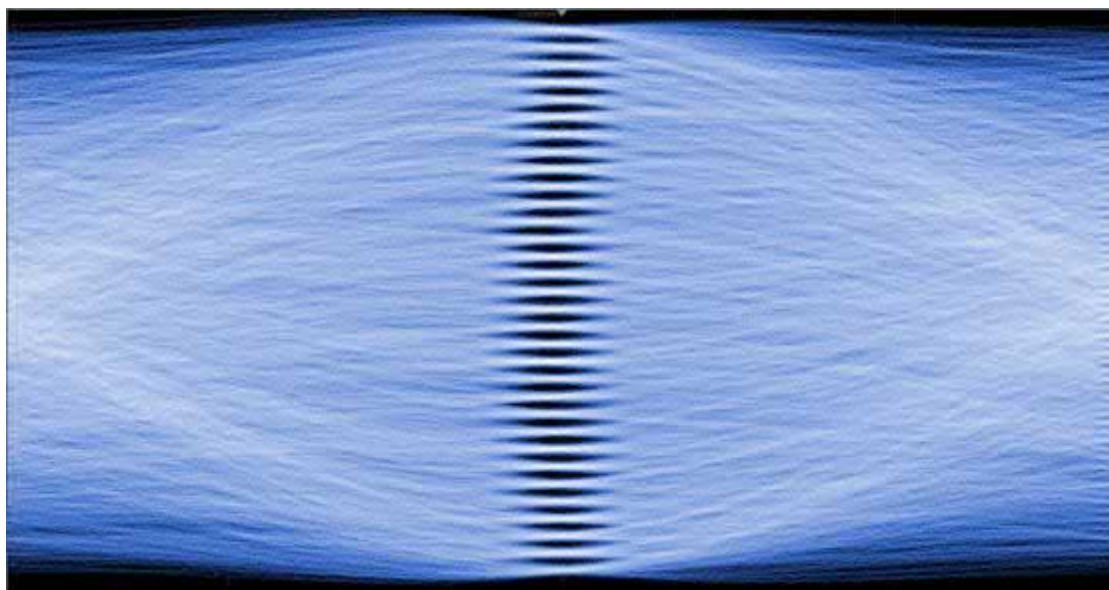

Figure 117 – 30 m - PAM 32 - 2.50 GBd - abscissa: 40 ps/div - ordinate: 120 mV

8.6.6 Transmission of 60 GBit/s over 30 m

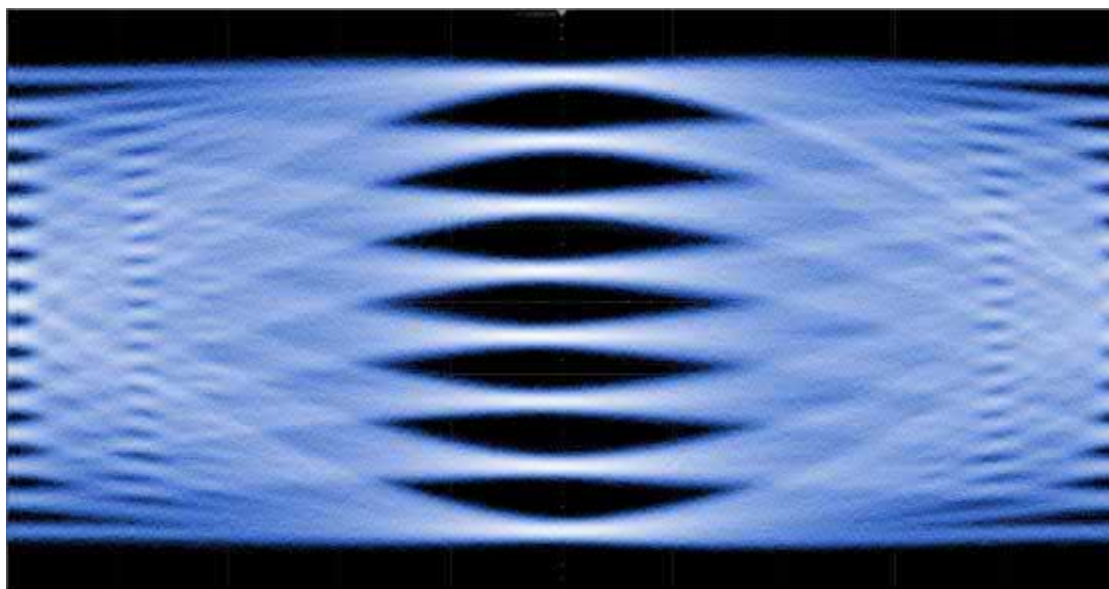

Figure 118 – 30 m - PAM 8 - 5.00 GBd - abscissa: 20 ps/div - ordinate: 72 mV

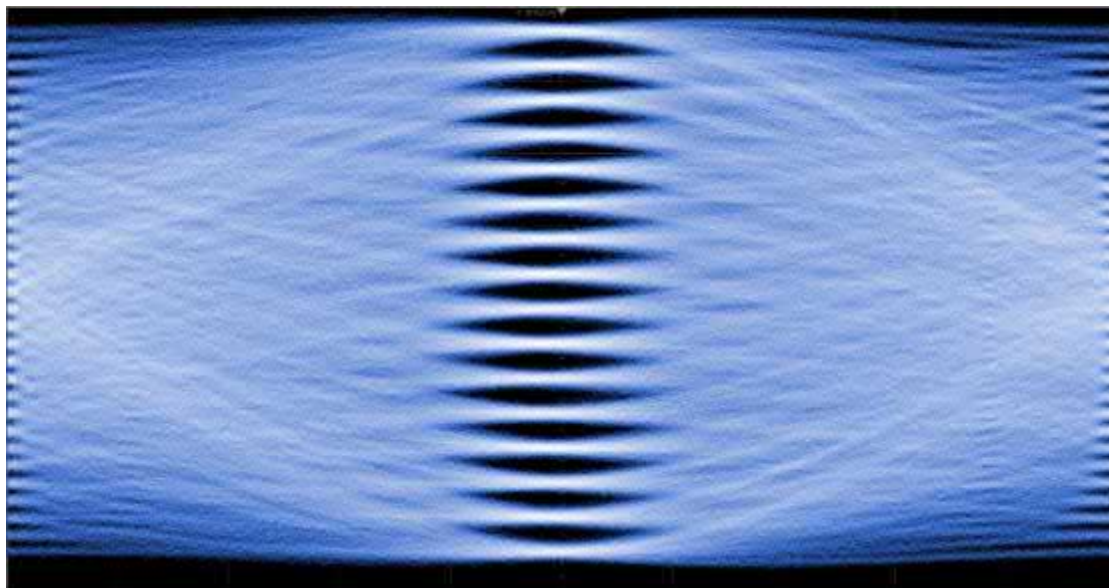

Figure 119 – 30 m - PAM 16 - 3.75 GBd - abscissa: 27 ps/div - ordinate: 94 mV

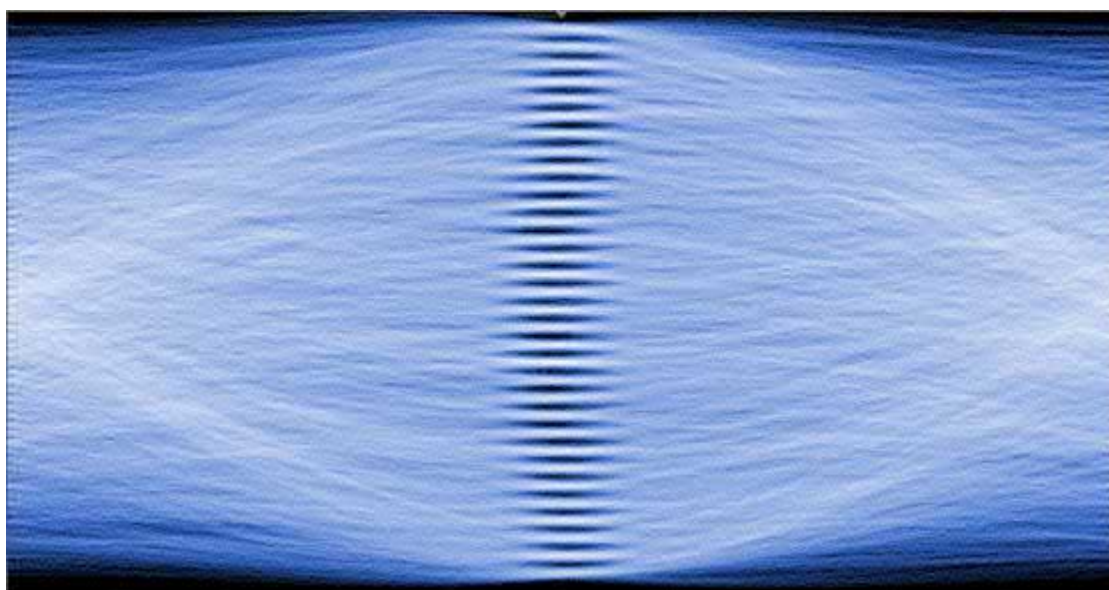

Figure 120 – 30 m - PAM 32 - 3.00 GBd - abscissa: 33 ps/div - ordinate: 110 mV

8.6.7 Transmission of 70 GBit/s over 30 m

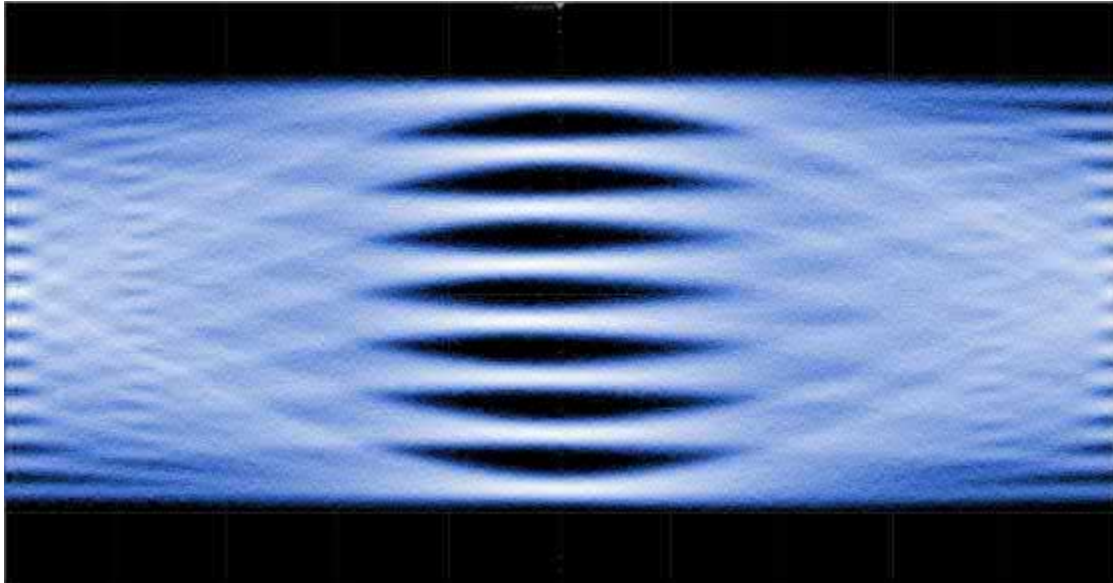

Figure 121 – 30 m - PAM 8 - 5.84 GBd - abscissa: 17 ps/div - ordinate: 62 mV

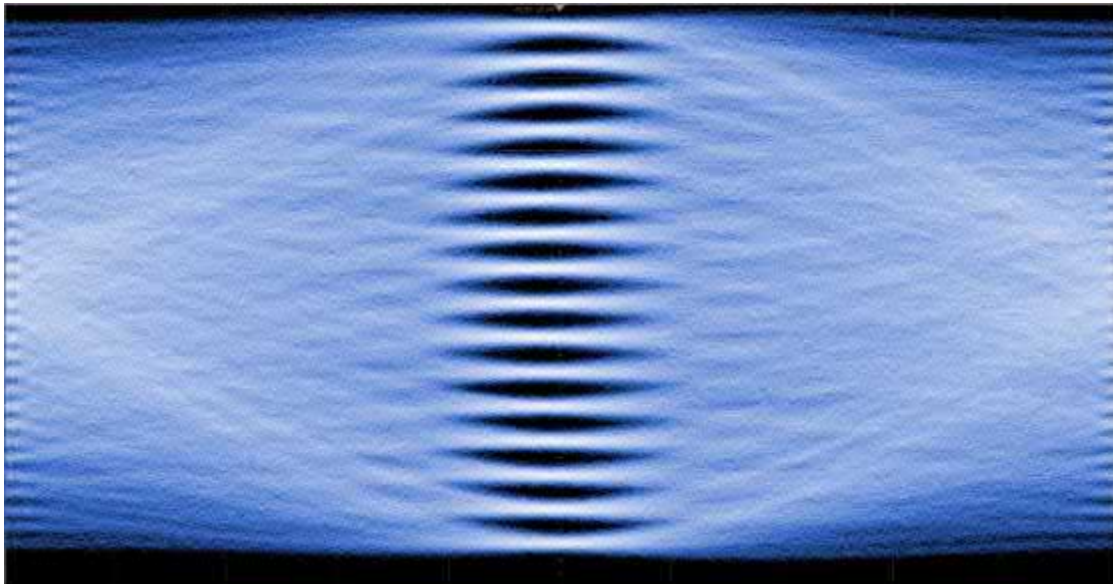

Figure 122 – 30 m - PAM 16 - 4.38 GBd - abscissa: 23 ps/div - ordinate: 84 mV

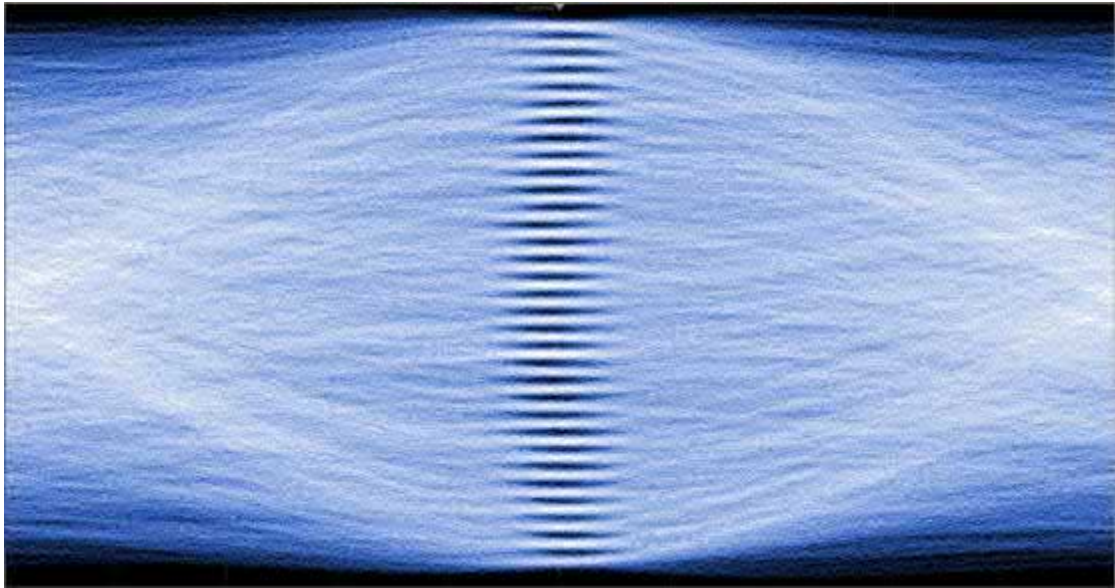

Figure 123 – 30 m - PAM 32 - 3.50 GBd - abscissa: 29 ps/div - ordinate: 94 mV

8.6.8 Transmission of 80 GBit/s over 30 m

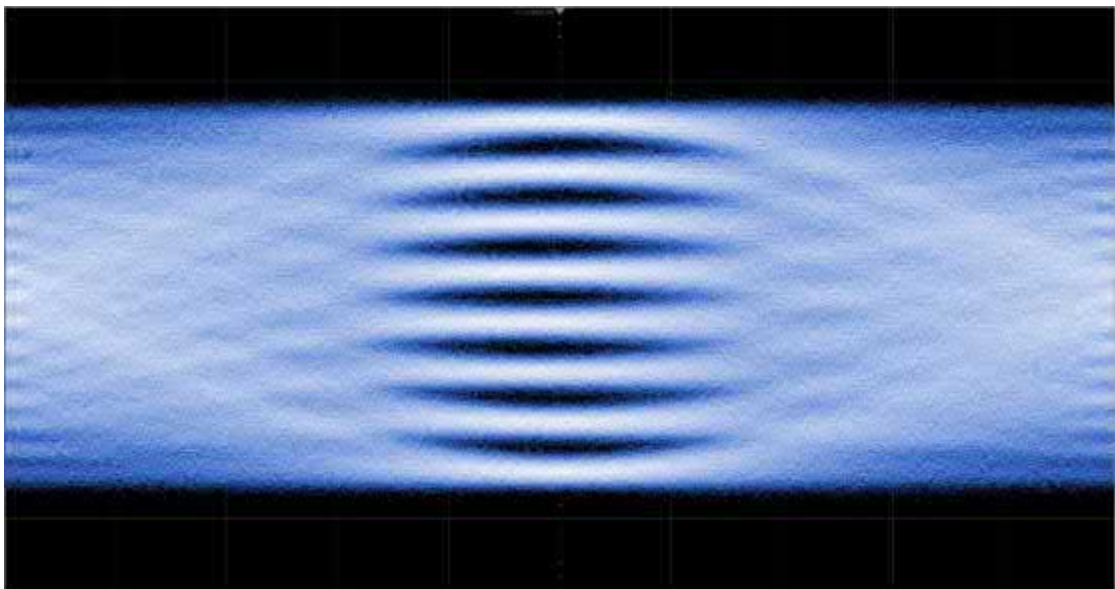

Figure 124 – 30 m - PAM 8 - 6.67 GBd - abscissa: 15 ps/div - ordinate: 52 mV

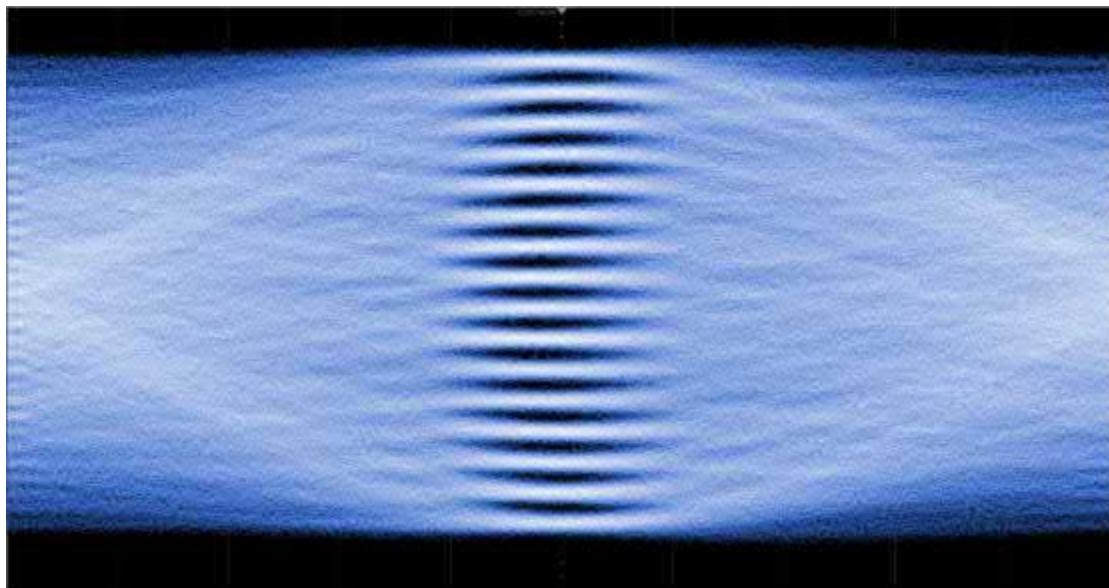

Figure 125 – 30 m - PAM 16 - 5.00 GBd - abscissa: 20 ps/div - ordinate: 72 mV

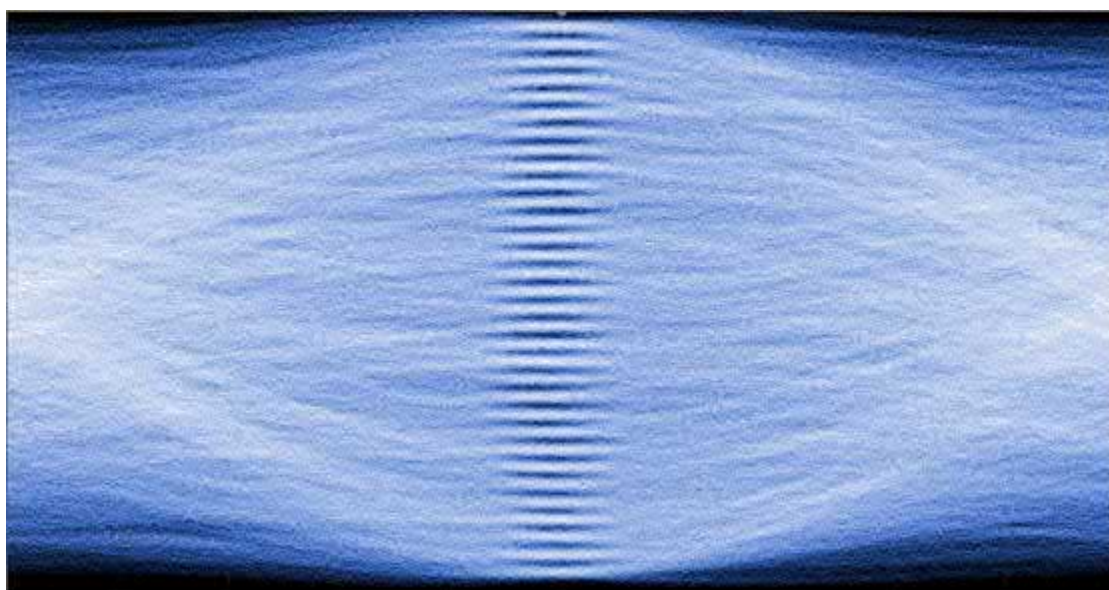

Figure 126 – 30 m - PAM 32 - 4.00 GBd - abscissa: 25 ps/div - ordinate: 88 mV

8.6.9 Transmission of 90 GBit/s over 30 m

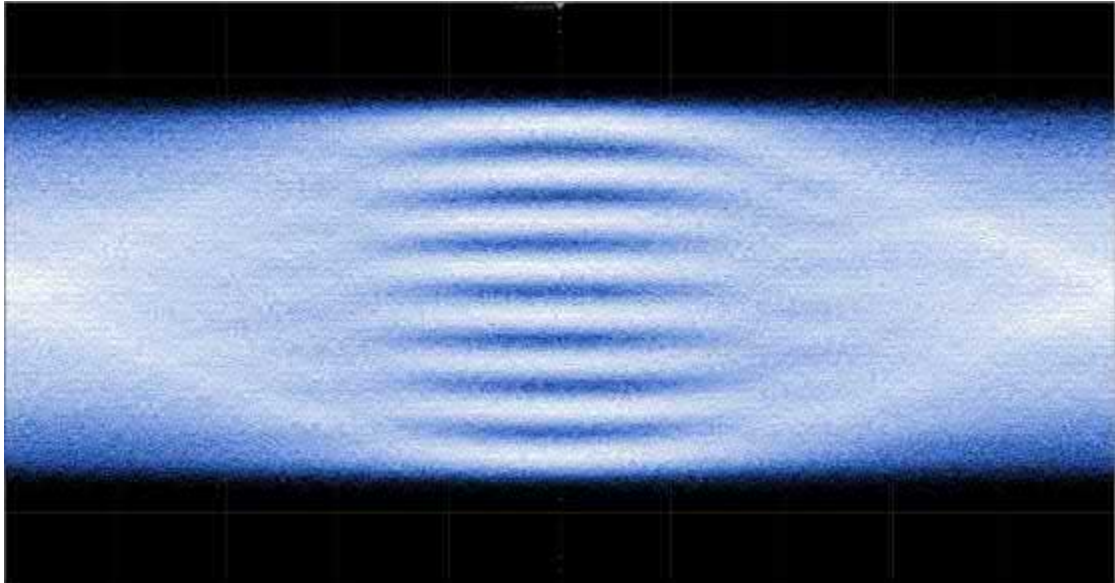

Figure 127 – 30 m - PAM 8 - 7.50 GBd - abscissa: 13 ps/div - ordinate: 46 mV

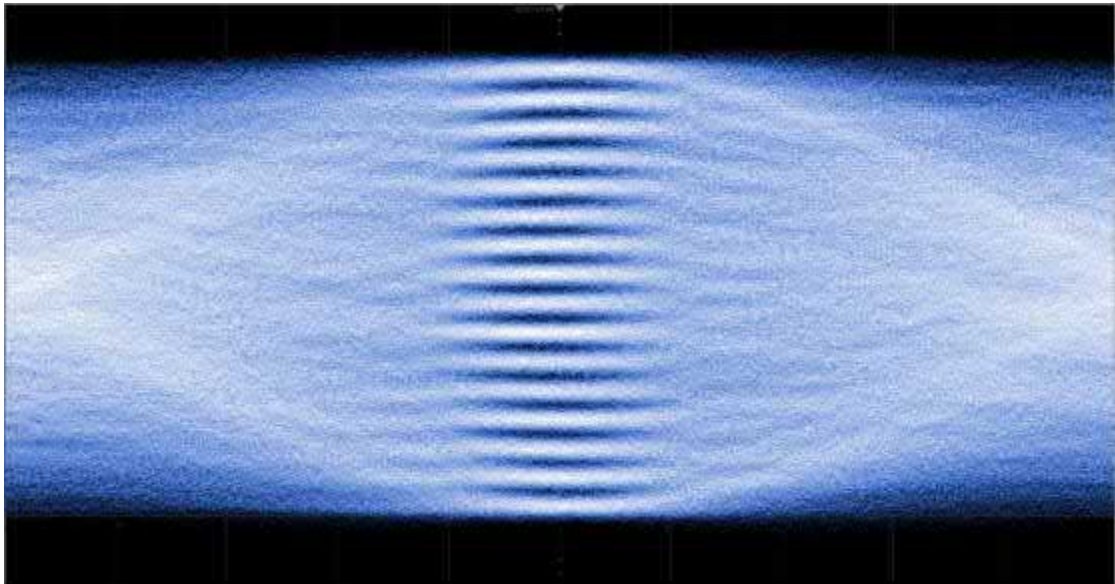

Figure 128 – 30 m - PAM 16 - 5.63 GBd - abscissa: 18 ps/div - ordinate: 64 mV



Figure 129 – 30 m - PAM 32 - 4.50 GBd - abscissa: 22 ps/div - ordinate: 80 mV

8.6.10 Transmission of 100 GBit/s over 30 m

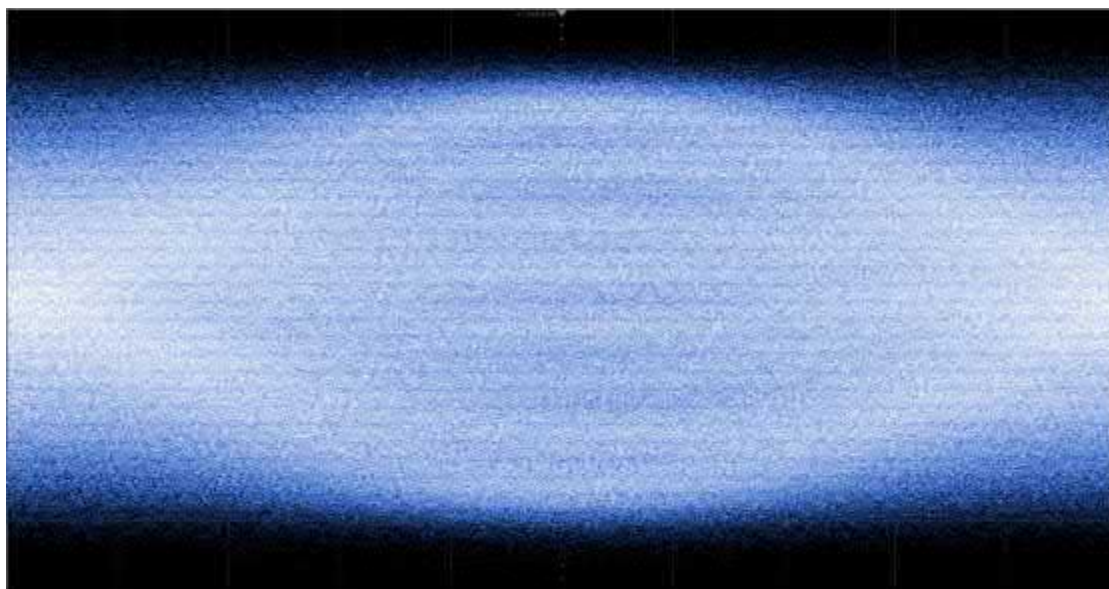

Figure 130 – 30 m - PAM 8 - 8.34 GBd - abscissa: 12 ps/div - ordinate: 46 mV

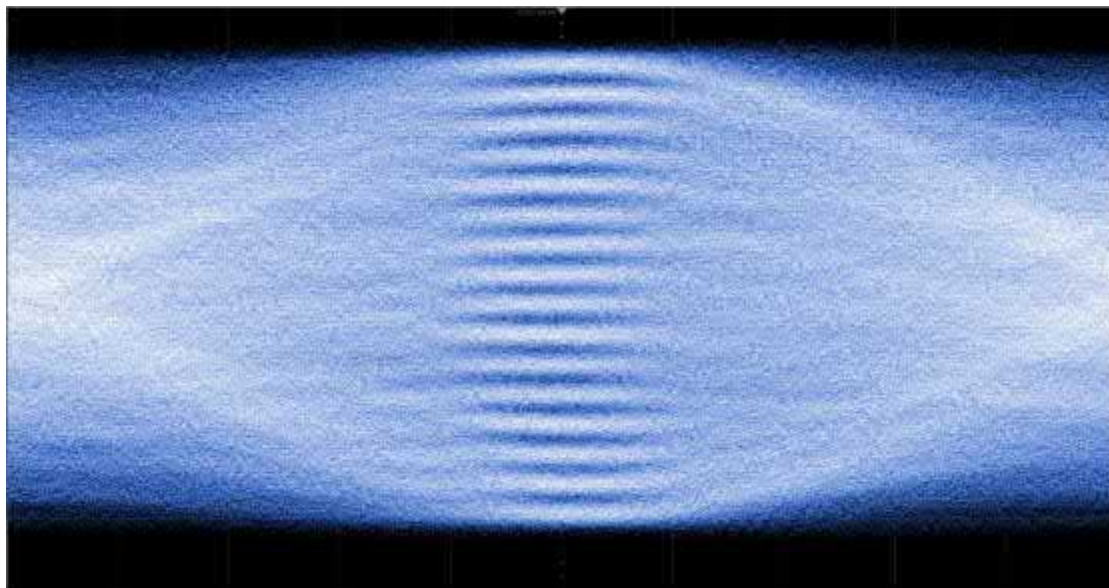

Figure 131 – 30 m - PAM 16 - 6.25 GBd - abscissa: 16 ps/div - ordinate: 58 mV

8.7 Transmission over 50 m

8.7.1 Transmission of 10 GBit/s over 50 m

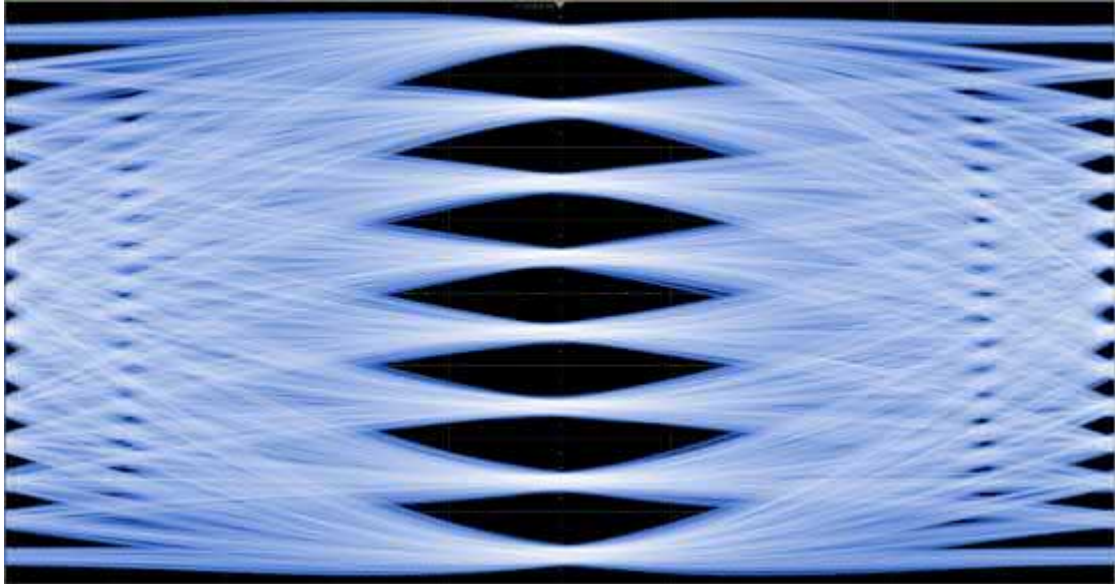

Figure 132 – 50 m - PAM 8 - 0.84 GBd - abscissa: 119 ps/div - ordinate: 170 mV

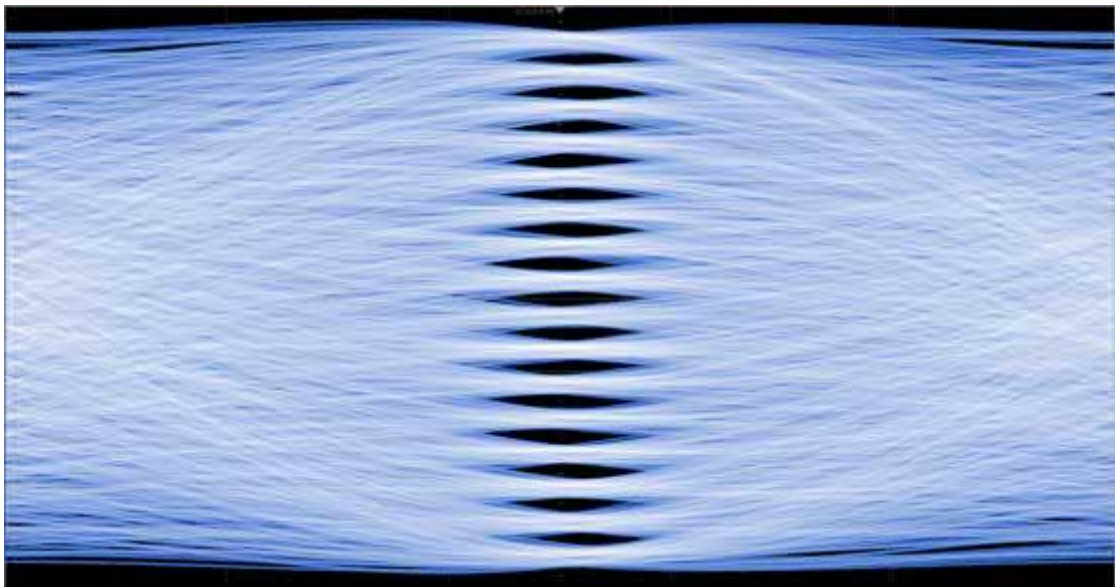

Figure 133 – 50 m - PAM 16 - 0.63 GBd - abscissa: 159 ps/div - ordinate: 180 mV

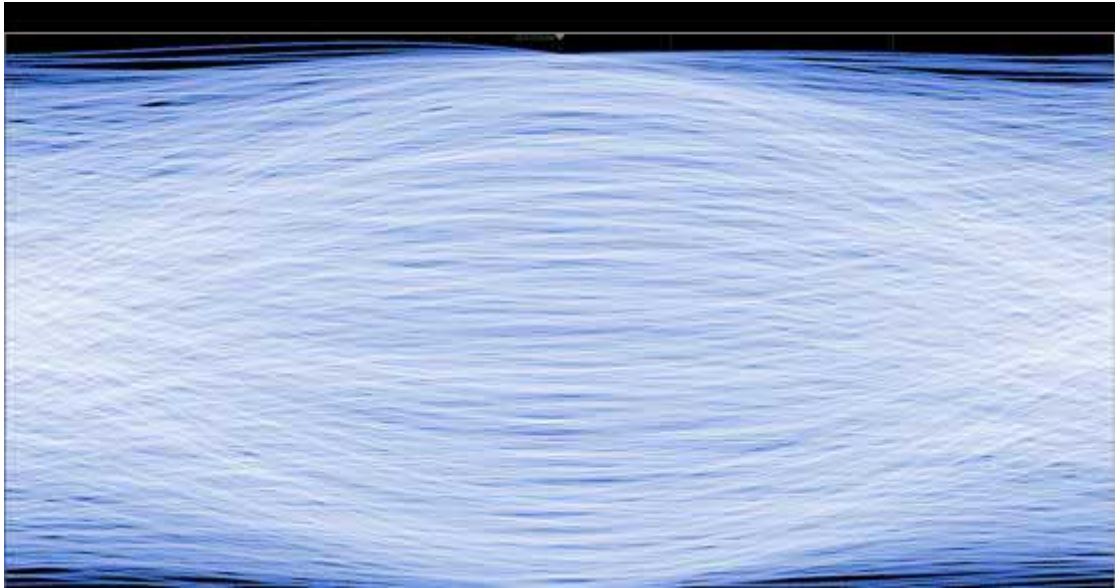

Figure 134 – 50 m - PAM 32 - 0.50 GBd - abscissa: 200 ps/div - ordinate: 190 mV

8.7.2 Transmission of 20 GBit/s over 50 m

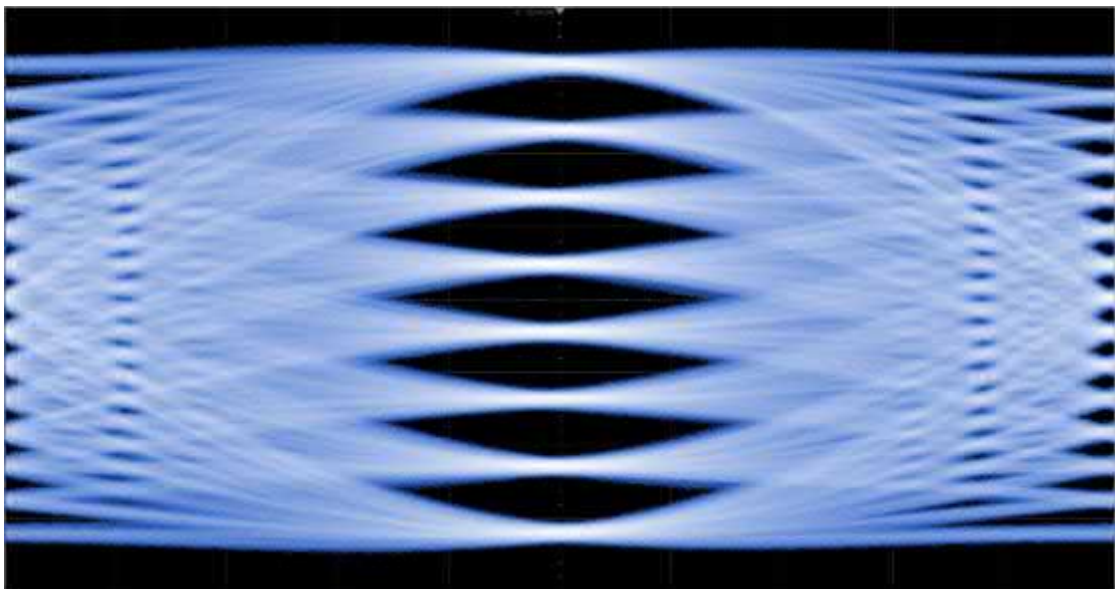

Figure 135 – 50 m - PAM 8 - 1.67 GBd - abscissa: 60 ps/div - ordinate: 140 mV

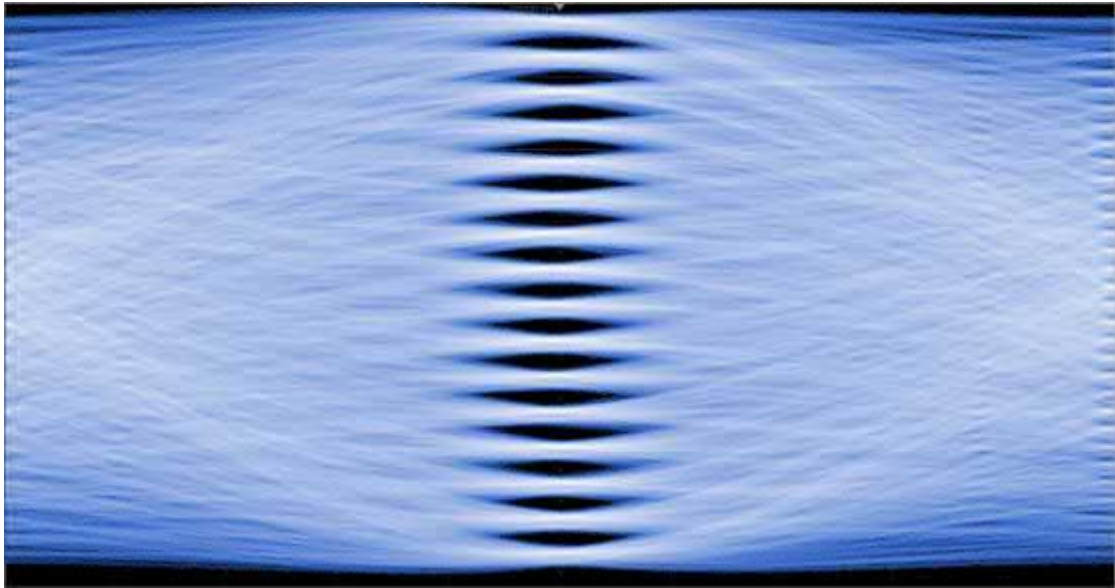

Figure 136 – 50 m - PAM 16 - 1.25 GBd - abscissa: 80 ps/div - ordinate: 160 mV

8.7.3 Transmission of 30 GBit/s over 50 m

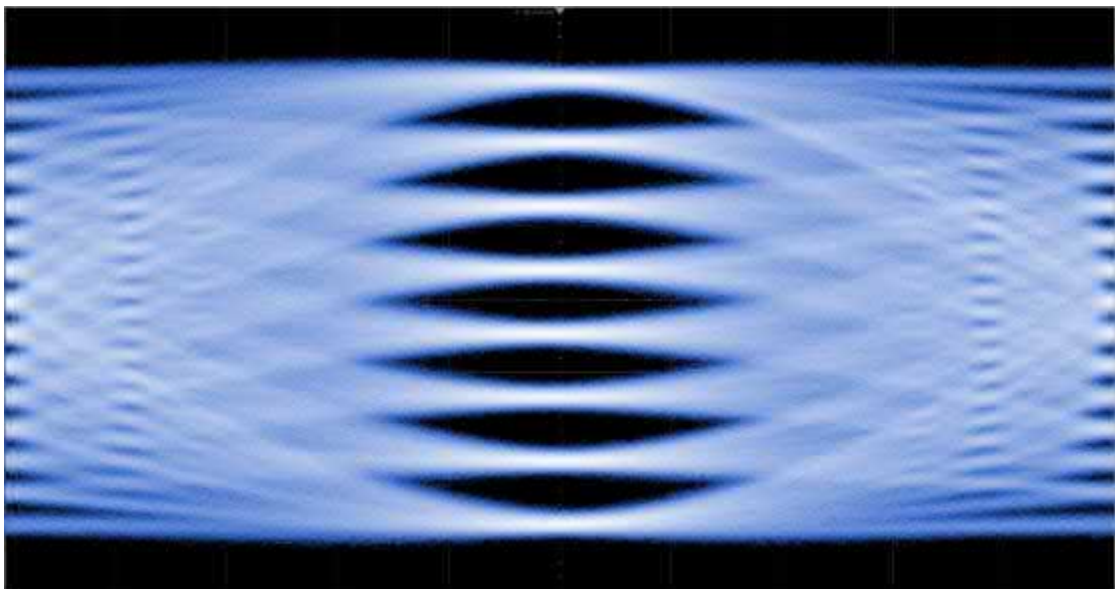

Figure 137 – 50 m - PAM 8 - 2.50 GBd - abscissa: 40 ps/div - ordinate: 120 mV

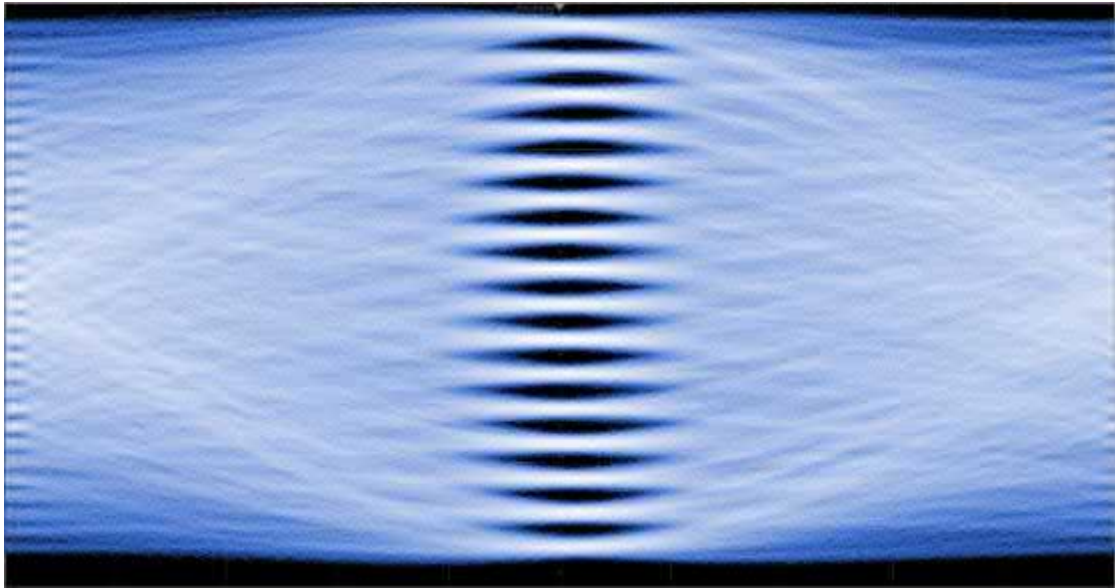

Figure 138 – 50 m - PAM 16 - 1.88 GBd - abscissa: 53 ps/div - ordinate: 130 mV

8.7.4 Transmission of 40 GBit/s over 50 m

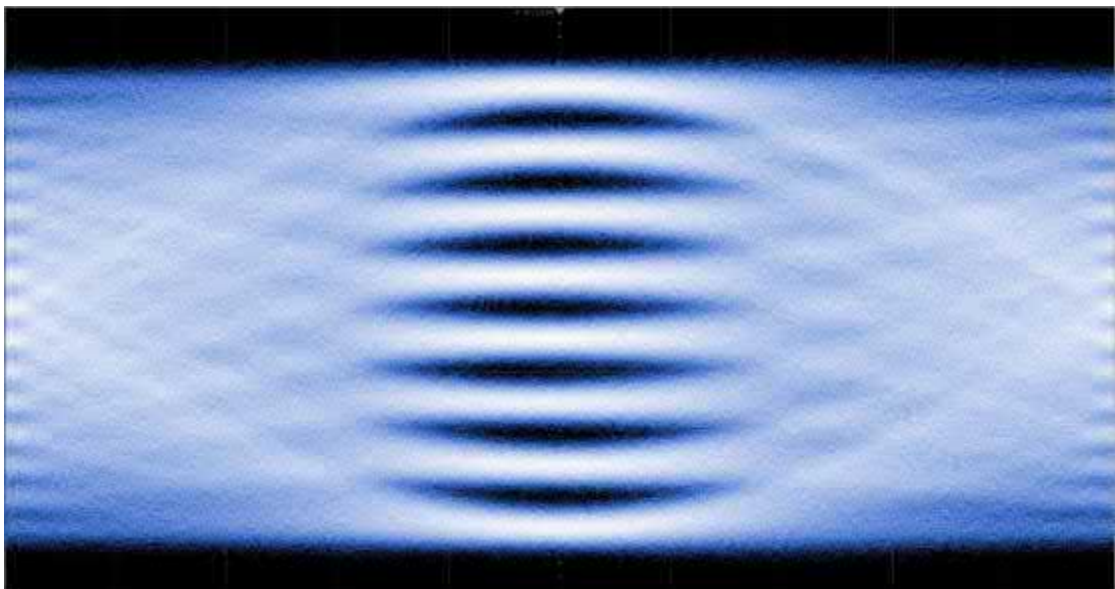

Figure 139 – 50 m - PAM 8 - 3.34 GBd - abscissa: 30 ps/div - ordinate: 100 mV

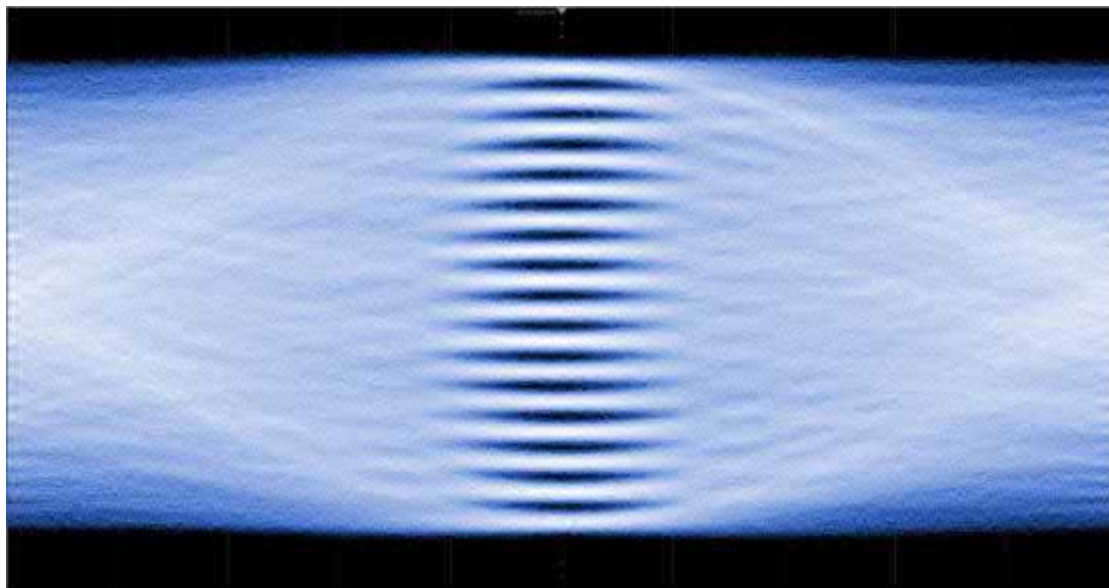

Figure 140 – 50 m - PAM 16 - 2.50 GBd - abscissa: 40 ps/div - ordinate: 120 mV

8.7.5 Transmission of 50 GBit/s over 50 m

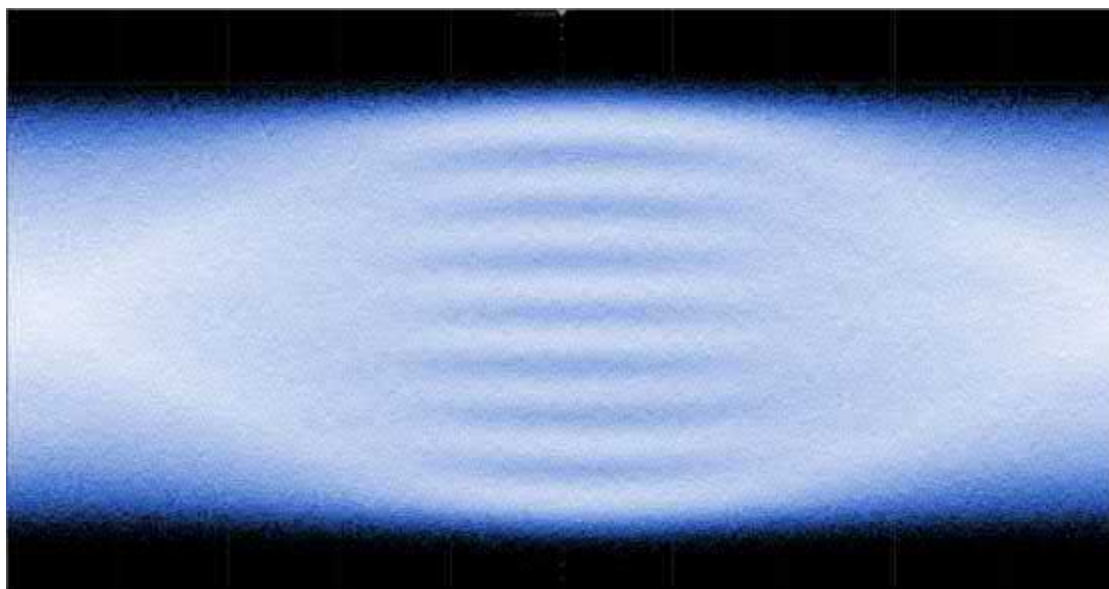

Figure 141 – 50 m - PAM 8 - 4.17 GBd - abscissa: 24 ps/div - ordinate: 88 mV

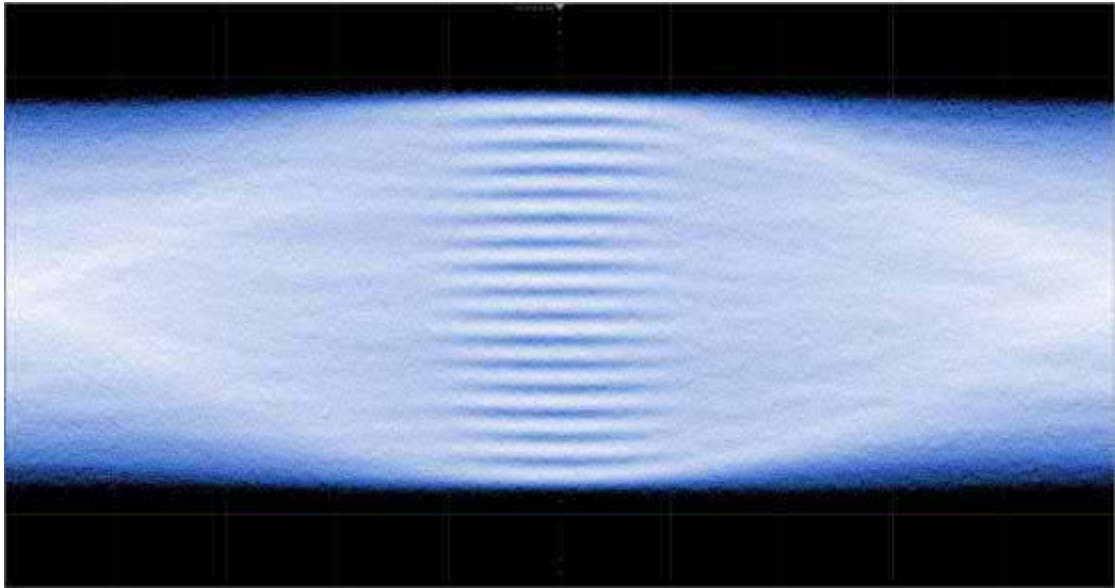

Figure 142 – 50 m - PAM 16 - 3.13 GBd - abscissa: 32 ps/div - ordinate: 110 mV

8.7.6 Transmission of 60 GBit/s over 50 m

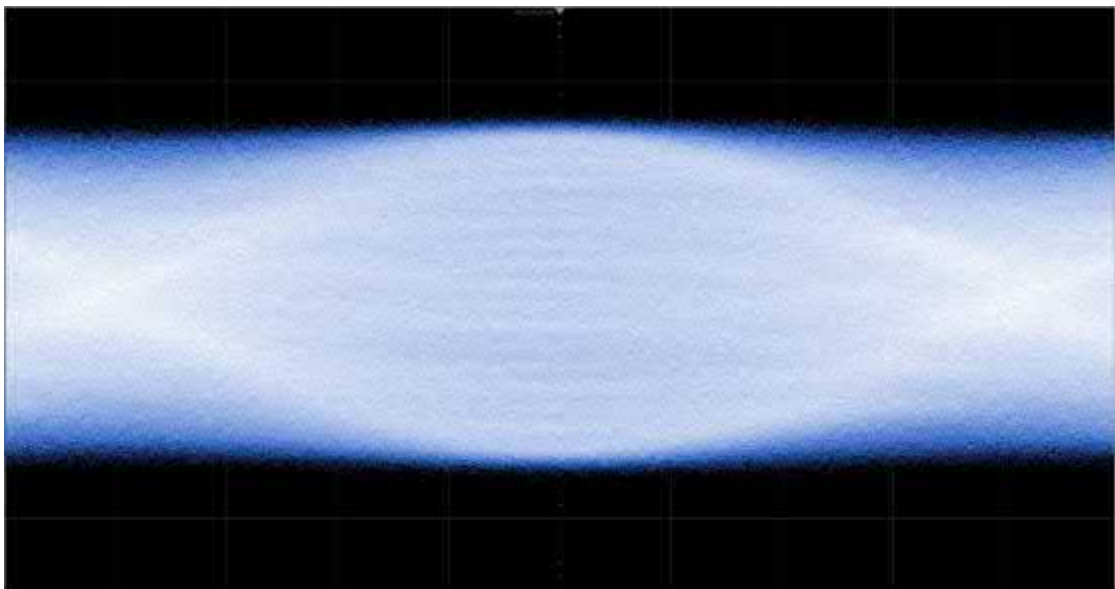

Figure 143 – 50 m - PAM 8 - 5.00 GBd - abscissa: 20 ps/div - ordinate: 72 mV

8.8 Transmission over 75 m

8.8.1 Transmission of 10 GBit/s over 75 m

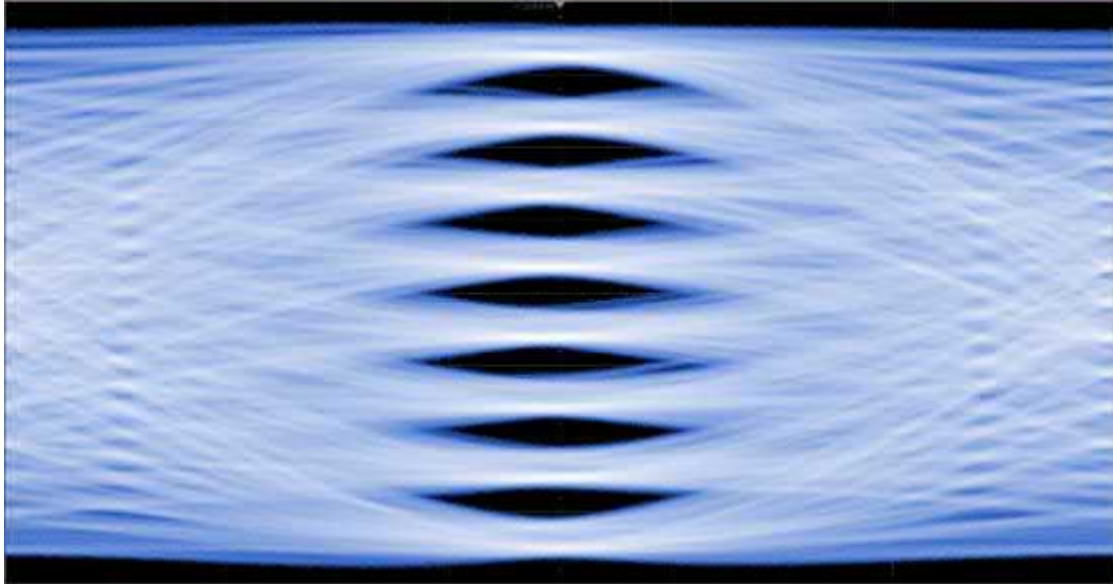

Figure 144 – 75 m - PAM 8 - 0.84 GBd - abscissa: 119 ps/div - ordinate: 170 mV

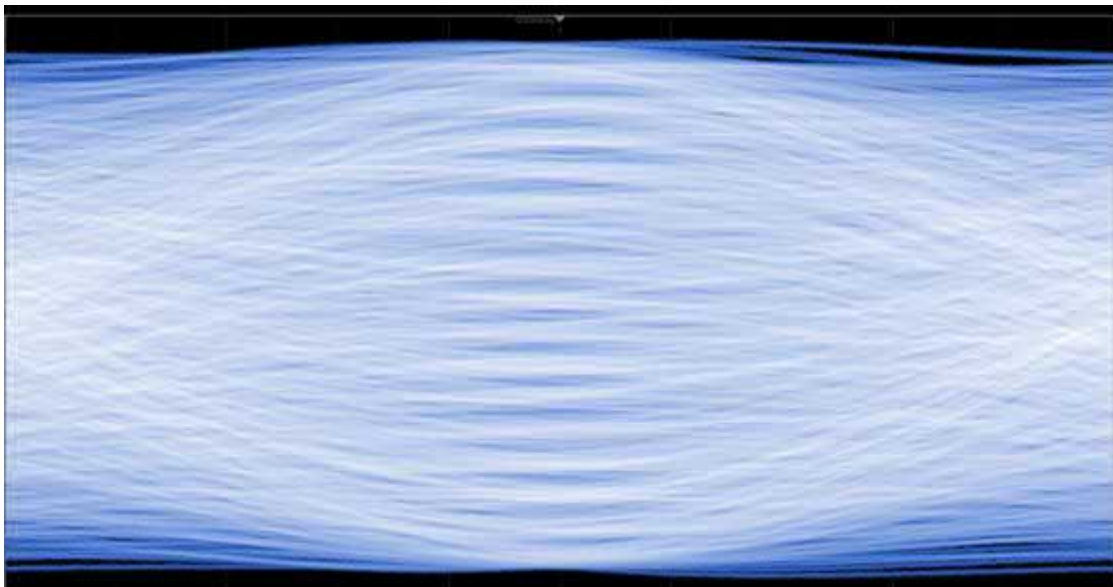

Figure 145 – 75 m - PAM 16 - 0.63 GBd - abscissa: 159 ps/div - ordinate: 180 mV

8.8.2 Transmission of 20 GBit/s over 75 m

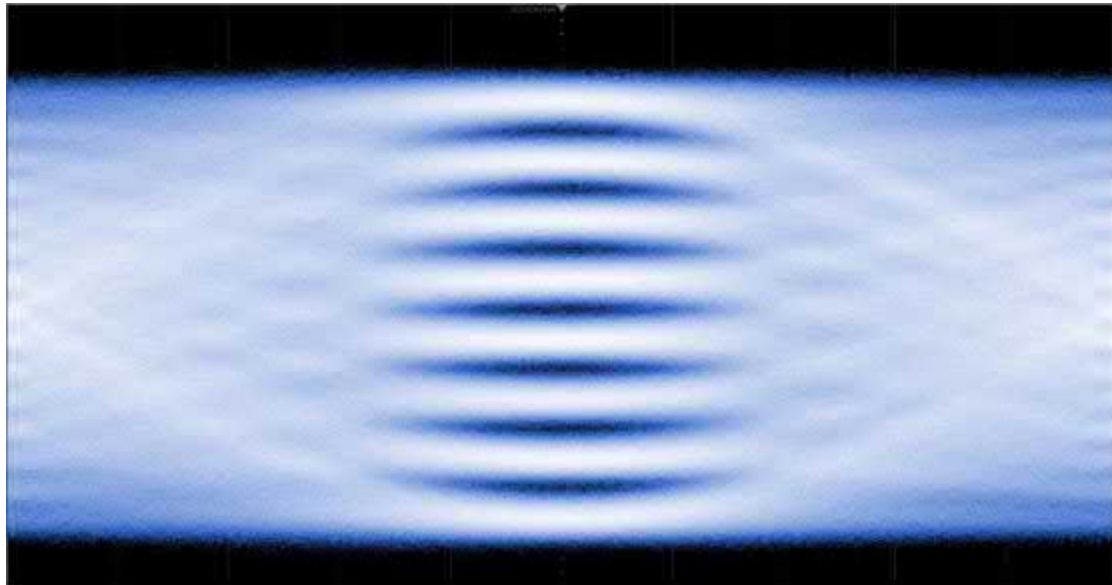

Figure 146 – 75 m - PAM 8 - 1.67 GBd - abscissa: 60 ps/div - ordinate: 140 mV

8.9 Transmission over 100 m

8.9.1 Transmission of 10 GBit/s over 100 m

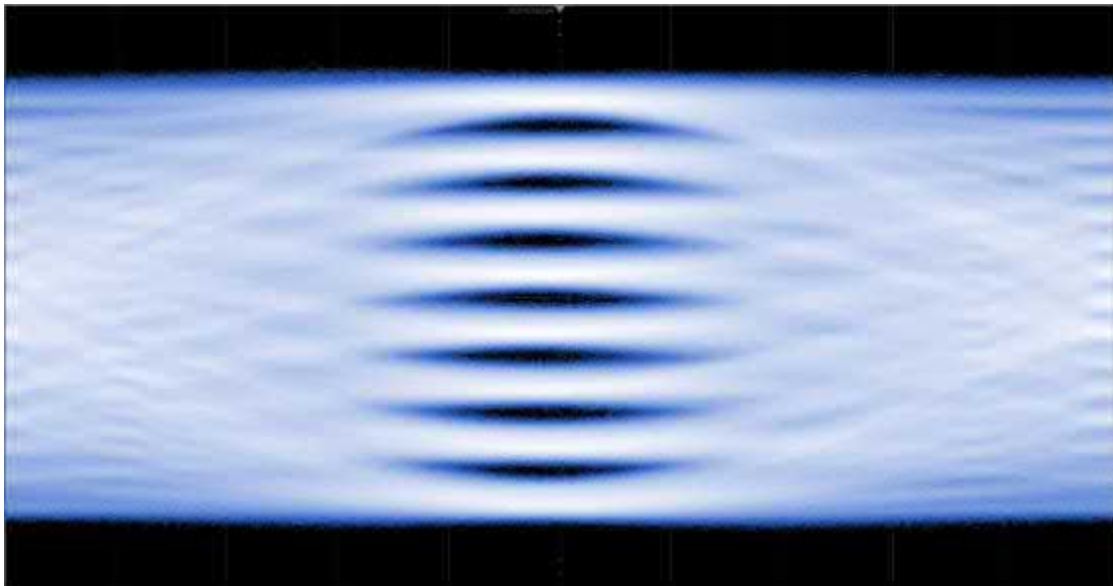

Figure 147 – 100 m - PAM8 - 0.84 GBd - abscissa: 119 ps/div - ordinate: 170 mV

8.9.2 Transmission of 20 GBit/s over 100 m

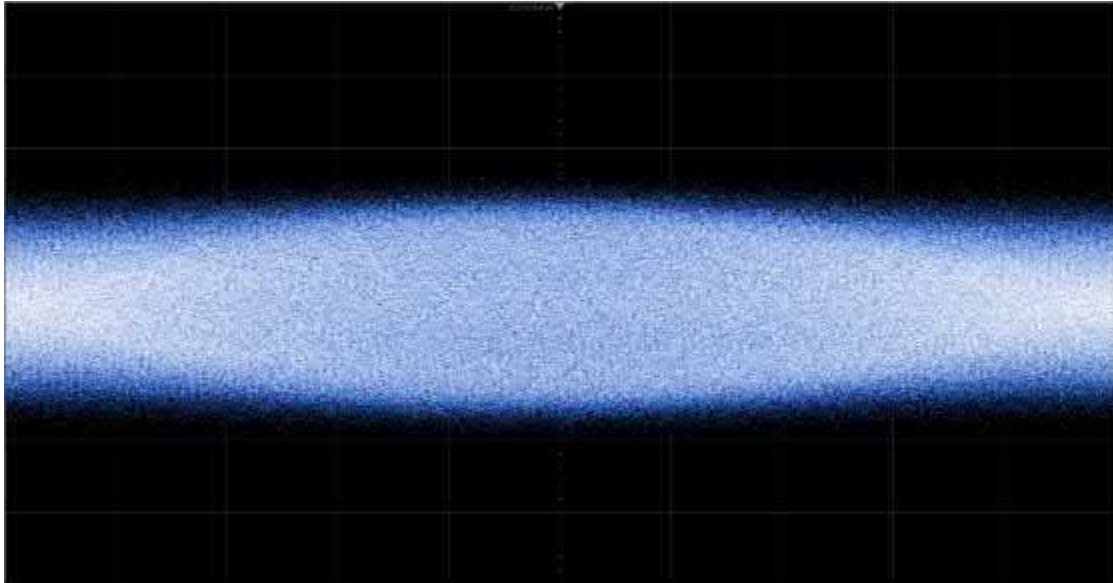

Figure 148 – 100 m - PAM 8 - 1.67 GBd - abscissa: 60 ps/div - ordinate: 140 mV

References

- [1] A. Oliviero and B. Woodward, *Cabling: The complete guide to copper and fiber-optic networking*, 4th ed. Indianapolis, IN: Wiley Pub, 2009. [Online]. Available: <http://site.ebrary.com/lib/alltitles/docDetail.action?docID=10317849>.
- [2] IEEE Standards Association, "802.3bq-2016 - IEEE Standard for Ethernet Amendment 3: Physical Layer and Management Parameters for 25 Gb/s and 40 Gb/s Operation, Types 25GBASE-T and 40GBASE-T," IEEE, Standard, 2016.
- [3] A. Duffy, K. G. Hodge, and A. J. Willis, "Technology Forecasting Techniques in Communications," in *Proceedings of the International Wire and Cable Symposium*, vol. 52, 2002, pp. 140–149.
- [4] A. P. Duffy, K. G. Hodge, and A. J. Willis, "Technology Forecasting and the Communication Cable Industry," in *Proceedings of the International Wire and Cable Symposium*, vol. 53, 2003, pp. 140–149.
- [5] Encyclopaedia Britannica, *Intel*, Encyclopaedia Britannica, Ed. [Online]. Available: <https://www.britannica.com/topic/Intel> (visited on 03/06/2019).
- [6] —, *Gordon Moore*, Encyclopaedia Britannica, Ed., 2019. [Online]. Available: <https://www.britannica.com/biography/Gordon-Moore> (visited on 03/06/2019).

- [7] G. Hellings and K. D. Meyer, *High Mobility and Quantum Well Transistors: Design and TCAD Simulation*. Dordrecht: Springer, 2013.
- [8] A. Inglis, V. Joosten, and P. Ling, *Delivering Digitally: Managing the Transition to the New Knowledge Media*, 2nd ed. Abingdon, Oxon: Taylor and Francis, 2012.
- [9] Anneya Golob, *Moore's Law: Nonlinear Fitting*, 2017. [Online]. Available: <http://www.ap.smu.ca/~agolob/phys2400/blog/exponentialFit/> (visited on 07/22/2019).
- [10] Cisco, "Cisco Visual Networking Index: Forecast and Methodology, 2009-2014," Cisco, USA, Tech. Rep., 2010.
- [11] —, "Cisco Visual Networking Index: Forecast and Trends, 2017-2022," Cisco, Tech. Rep., 2019. [Online]. Available: <https://www.cisco.com/c/en/us/solutions/collateral/service-provider/visual-networking-index-vni/white-paper-c11-741490.html> (visited on 02/18/2020).
- [12] IEEE Standards Association, "IEEE 802.3u-1995 - IEEE Standards for Local and Metropolitan Area Networks: Supplement - Media Access Control (MAC) Parameters, Physical Layer, Medium Attachment Units, and Repeater for 100Mb/s Operation, Type 100BASE-T (Clauses 21-30): 1993; A," IEEE, Tech. Rep., 1995. [Online]. Available: <http://ieeexplore.ieee.org/servlet/opac?punumber=7974914>.
- [13] —, "IEEE 802.3ab-1999 - IEEE Standard for Information Technology - Telecommunications and information exchange between systems - Local and Metropolitan Area Networks - Part 3: Carrier Sense Multiple Access with Collision Detection (CSMA/CD) Access," IEEE, Tech. Rep., 1999.

- [14] —, “IEEE Std 802.3i-1990 - IEEE Standard for Local and Metropolitan Area Networks - System Considerations for Multisegment 10 Mb/S Baseband Networks (Section 13) and Twisted-Pair Medium Attachment Unit (MAU) and Baseband Medium, Type 10BASE-T (Sect.,” IEEE, Tech. Rep., 1990.
- [15] —, “IEEE 802.3an-2006 - IEEE Standard for Information Technology - Telecommunications and Information Exchange Between Systems – LAN/MAN - Specific Requirements Part 3: CSMA/CD Access Method and Physical Layer Specifications - Amendment: Physical,” IEEE, Tech. Rep., 2006.
- [16] A. M. Oehler, K. Seitz, D. Schicketanz, A. Frank, R. Schmidt, and M. Witte, “100 Gbps over four pair balanced cabling,” *International Wire & Cable Symposium, Proceedings of the 63 rd IWCS Conference*, vol. 63, 2014.
- [17] K. Seitz and Prof. Dr. A. Oehler, “Line Encoding for 25 Gbps over one Pair Balanced Cabling,” in *SInCom 2014 - Baden-Württemberg Center of Applied Research Symposium on Information and Communication Systems*, vol. 1, 2014, pp. 34–37.
- [18] Fraunhofer, *Digitalization Is Changing the Future of Manufacturing*, Fraunhofer IFF, Ed., 2019. [Online]. Available: <https://www.fraunhofer.de/en/research/current-research/older-articles/production-4-0.html> (visited on 03/06/2019).
- [19] A. Oehler, Y. Engels, R. Schmid, and K. Seitz, “100 Gbit/s über 4-paarige symmetrische Verkabelung – Vision oder Realität?” *Horizonte*, vol. 48, pp. 49–52, 2016.
- [20] L. Szczecinski and A. Alvarado, *Bit-interleaved coded modulation: Fundamentals, analysis, and design*. West Sussex: Wiley, 2015. [Online]. Available: <http://dx.doi.org/10.1002/9781118694077>.

- [21] R. Mollar, *An explosion of online video could triple bandwidth consumption again in the next five years: What the internet will look like in 2021*. recode, Ed., 2017. [Online]. Available: <https://www.recode.net/2017/6/8/15757594/future-internet-traffic-watch-live-video-facebook-google-netflix> (visited on 07/24/2019).
- [22] J. Duran, *Highspeed Ethernet The need for speed: White Paper Molex Premise Networks*, Molex, Ed., 2014.
- [23] T. Hüscher, *Need for Speed: 40GBase-T in Data Center Networks*, Softing IT Networks GmbH, Ed., 2019. [Online]. Available: https://itnetworks.softing.com/fileadmin/media/documents/whitepaper/Whitepaper_Encircled_Flux_ENG.pdf (visited on 07/24/2019).
- [24] J. R. Barry, E. A. Lee, and D. G. Messerschmitt, *Digital Communication*, Third Edition. Boston, MA: Springer, 2004.
- [25] IEEE Standards Association, "IEEE Std 802.3ab-1999 Information technology: Telecommunications and information exchange between systems—local and metropolitan area networks—specific requirements : supplement to carrier sense multiple access with collision detection (CSMA/CD)," IEEE, New York, NY, Tech. Rep., 1999. [Online]. Available: <http://ieeexplore.ieee.org/servlet/opac?punumber=6488>.
- [26] *IEEE Standard for information technology: Telecommunications and information exchange between systems-specific requirements : Part 3, Carrier sense multiple access with collision detection (CSMA/CD) access method and physical layer specification*, New York, 2007.
- [27] International Electrotechnical Commission, *Multicore and symmetrical pair/quad cables for digital communications - Part 9: Cables for channels with transmission characteristics up to 2 GHz - Sectional specification*, Geneva, 2016.

- [28] —, *Multicore and symmetrical pair/quad cables for digital communications - Part 10: Cables for cords with transmission characteristics up to 2 GHz - Sectional specification*, Geneva, 2016.
- [29] DKE, “DIN EN 50288-9-1:2013: Mehradrige metallische Daten- und Kontrollkabel für analoge und digitale Übertragung – Teil 9-1: Rahmenspezifikation für geschirmte Kabel bis 1000 MHz – Kabel für den Horizontal- und Steigbereich;” DKE, Frankfurt, Tech. Rep., 2013.
- [30] C. Spurgeon and J. Zimmerman, *Ethernet: The definitive guide*, 2nd ed. Sebastopol, CA: O’Reilly, 2014.
- [31] Cisco, “Cisco Visual Networking Index: Forecast and Methodology, 2014-2019,” Cisco, USA, Tech. Rep., 2015.
- [32] B. Woodward and E. B. Husson, *Fiber optics installer and technician guide*. Alameda, Calif.: SYBEX, 2005.
- [33] R. L. Smith and S. L. Herman, *Electrical wiring, industrial*, 12th ed. Australia and Clifton Park, N.Y.: Thomson/Delmar Learning, 2005.
- [34] J. Trulove, *LAN wiring: Category 7 and augmented category 6 ; copper and fiber cabling for 10-Gigabit Ethernet speeds ; TIA/EIA 568-C standard updates ; 802.11 WiFi to over 100 Mbps*, 3. ed. New York, NY: McGraw-Hill, 2006. [Online]. Available: <http://www.loc.gov/catdir/enhancements/fy0669/2005054686-b.html>.
- [35] S. Kal, *Basic electronics: Devices, circuits and IT fundamentals*. New Delhi: Prentice-Hall of India, 2012.
- [36] B. G. Lipták, *Instrument engineers’ handbook*, 3rd ed. Boca Raton: CRC Press, 1999.

- [37] G. Held, *Ethernet networks: Design, implementation, operation, management*, 4th ed. West Sussex: Wiley, 2003.
- [38] I. Kateeb, L. Burton, M. S. Peluso, P. Chopade, and K. AlOtaibi, "Copper cables: Should they be phased out as last mile broadband solutions?" *Proceedings of IEEE Southeastcon*, pp. 1–7, 2013.
- [39] S. Maniktala, *Power over ethernet interoperability*. New York: McGraw-Hill, 2013.
- [40] P. T. H. Unwin, Ed., *ICT4D: Information and communication technology for development*. Cambridge: Cambridge University Press, 2009.
- [41] wiseGEEK, *What is 4G Technology?* 2019. [Online]. Available: <https://www.wisegeek.com/what-is-4g-technology.htm> (visited on 05/30/2019).
- [42] Chris Hoffman, *What Is 5G, and How Fast Will It Be?* 2019. [Online]. Available: <https://www.howtogeek.com/340002/what-is-5g-and-how-fast-will-it-be/> (visited on 07/23/2019).
- [43] N. Greene and R. Perry, *The Tipping Point Is Here - All-Wireless Workplaces Show Benefit over Traditional Wired Technology*. USA, 2014.
- [44] Ed Lieber, *Fibre, Copper, or Wireless: Which Connection Is Best For Your Company?* 2019. [Online]. Available: <https://smallbiztrends.com/2015/08/fiber-optic-copper-wireless-internet-transmission-methods.html> (visited on 07/24/2019).
- [45] Advantages and Disadvantages. (2019). Advantages and Disadvantages of Wireless Networks, [Online]. Available: <https://www.advantages-disadvantages.co/wireless-networks-advantages-and-disadvantages/> (visited on 05/30/2019).

- [46] V. Kumkar, A. Timari, P. Tiwari, A. Gupta, and S. Shrawne, "Vulnerabilities of Wireless Security protocols (WEP and WPA 2)," *International Journal of Advanced Research in Computer Engineering & Technology*, vol. 1, pp. 34–38, 2012.
- [47] D. Tse and P. Viswanath, *Fundamentals of wireless communication*. Cambridge, New York, Melbourne, Madrid, Cape Town, Singapore, São Paulo: Cambridge University Press, 2005.
- [48] K. R. Skøien, *Wireless Network Topologies*, Nordic Semiconductor, Ed., 2018. [Online]. Available: <https://blog.nordicsemi.com/getconnected/wireless-network-topologies> (visited on 06/12/2019).
- [49] M. Werner, *Nachrichtentechnik: Eine Einführung für alle Studiengänge, 7.*, Wiesbaden: Vieweg+Teubner Verlag / Springer Fachmedien Wiesbaden GmbH Wiesbaden, 2010. DOI: 10.1007/978-3-8348-9742-8. [Online]. Available: <http://dx.doi.org/10.1007/978-3-8348-9742-8>.
- [50] C.-C. Lee, *The Current Trends of Optics and Photonics*. Dordrecht: Springer Netherlands, 2015.
- [51] A. A. Huurdeman, *The worldwide history of telecommunications*. Hoboken, NJ: Wiley-Interscience, 2003.
- [52] G. Held, *Understanding data communications: From fundamentals to networking*. West Sussex: Wiley, 2001.
- [53] C. Liang, Y. Li, and J. Luo, "A Novel Method to Detect Functional microRNA Regulatory Modules by Bicliques Merging," *IEEE/ACM transactions on computational biology and bioinformatics*, vol. 13, no. 3, pp. 549–556, 2013.
- [54] J. M. Cioffi, V. Oksman, J.-J. Werner, T. Pollet, P. M. P. Spruyt, J. S. Chow, and K. S. Jacobsen, "Very-High-Speed Digital Subscriber Lines," *IEEE Communications Magazine*, vol. 37, no. 4, pp. 72–79, 1999.

References

- [55] A. G. Bell, "Telephone-circuit," US244426A, Jul. 19, 1881. [Online]. Available: <https://patents.google.com/patent/US244426A/en> (visited on 02/18/2020).
- [56] A. Grami, *Introduction to Digital Communications*. London: Academic Press, 2015.
- [57] D. W. Hoffmann, *Einführung in die Informations- und Codierungstheorie*. Berlin: Springer Vieweg, 2014.
- [58] F. Betz, *Managing Technological Innovation: Competitive Advantage from Change*, 3rd ed. Hoboken, NJ: Wiley, 2011.
- [59] B. Metcalfe, "Metcalfe's Law after 40 Years of Ethernet," *IEEE Computer Society*, vol. 46, no. 12, pp. 26–31, 2013.
- [60] K. Pahlavan and P. Krishnamurthy, *Networking fundamentals: Wide, local and personal area communications*. Hoboken, NJ: Wiley, 2009.
- [61] J. Huntington, *Show networks and control systems*, Second edition. Brooklyn, N.Y.: Zircon Designs Press, 2017.
- [62] T. Hüscher, "Datenübertragungstechnik: Normen - Installation - Messtechnik (1)," *de - das elektrohandwerk*, vol. 17, pp. 64–68, 2013.
- [63] W. Fischer, *Digitale Fernseh- und Hörfunktechnik in Theorie und Praxis: MPEG-Basisbandcodierung, DVB-, DAB-, ATSC-, ISDB-T-Übertragungstechnik, Messtechnik*, 3. ed. Berlin: Springer-Verlag, 2010.
- [64] F. A. Benson and T. M. Benson, *Fields, Waves and Transmission Lines*. Luxemburg: Springer Science Business Media, 1991.

- [65] F. Rachidi and S. Tkachenko, *Electromagnetic Field Interaction with Transmission Lines: From Classical Theory to HF Radiation Effects*. Ashurst: WIT Press, 2008. [Online]. Available: <https://ebookcentral.proquest.com/lib/gbv/detail.action?docID=511998>.
- [66] D. K. Cheng, *Field and Wave Electromagnetics*, 2. ed. Reading, Mass.: Pearson Academic, 1989.
- [67] LEONI Kerpen GmbH, *LEONI Technical Bulletin - Data communication technology 12/2015: UTP vs STP - Shielded data cables make the grade - Unshielded data cables reach the limits of their performance*, 2015.
- [68] A. A. Gokhale, *Introduction to telecommunications*, 2nd ed. Clifton Park, NY: Thomson/Delmar Learning, 2005.
- [69] J. S. Beasley and P. Nilkaew, *Networking Essentials*, 3rd ed. Indianapolis, Ind.: Pearson, 2012.
- [70] A. Semenov, S. Strizhakov, N. Bolotnik, I. Suncheley, and J. Bogatova, *Structured Cable Systems*, ser. Engineering online library. Springer, 2002.
- [71] B. J. Elliott, *Designing a structured cabling system to ISO 11801 2nd edition: Cross-referenced to European CENELEC and American standards*. Cambridge: Woodhead Publishing Limited, 2002.
- [72] A. Flatman, *IEEE 802.3 meeting - nov 2011 & jan 2012*, Madrid, 2012.
- [73] IEEE Advancing Technology for Humanity, *History of IEEE*, 2019. [Online]. Available: <https://www.ieee.org/about/ieee-history.html> (visited on 05/30/2019).
- [74] M. J. N. Sibley, *Modern Telecommunications: Basic Principles and Practices*. Milton: Chapman and Hall/CRC, 2018. [Online]. Available: <https://ebookcentral.proquest.com/lib/gbv/detail.action?docID=5352288>.

- [75] T. Hüs ch, “Datenübertragungstechnik: Normen - Installation - Messtechnik (2),” *de - das elektrohandwerk*, vol. 18, pp. 57–60, 2013.
- [76] International Electrotechnical Commission, *Multicore and symmetrical pair/quad cables for digital communications – Part 5: Symmetrical pair/quad cables with transmission characteristics up to 1 000 MHz-horizontal floor wiring – Sectional specification*, Geneva, 2009.
- [77] —, *Multicore and symmetrical pair/quad cables for digital communications – Part 6: Symmetrical pair/quad cables with transmission characteristics up to 1 000 MHz – Work area wiring – Sectional specification*, Geneva, 2010.
- [78] T. Hüs ch, “Datenübertragungstechnik: Normen - Installation - Messtechnik (3),” *de - das elektrohandwerk*, vol. 20, pp. 55–59, 2013.
- [79] J. Crisp, *Introduction to copper cabling: Application for telecommunications, data communications and networking*. Niederlande: Newnes, 2002.
- [80] T. Hüs ch, “Datenübertragungstechnik: Normen - Installation - Messtechnik (4),” *de - das elektrohandwerk*, vol. 21, pp. 64–68, 2013.
- [81] E. C. Arihilam, H. G. Sasse, A. P. Duffy, P. Cave, and J. Withey, “Investigating common-mode to differential-mode conversion in a four pair twisted cable,” *International Wire & Cable Symposium*, vol. Proceedings of the 65th IWCS Conference, pp. 126–132, 2017.
- [82] Omega, *Analog Signal Transmission*, 2019. [Online]. Available: <https://www.omega.com/literature/transactions/volume2/analogsignal2.html> (visited on 01/17/2019).
- [83] C. R. Paul, *Introduction to electromagnetic compatibility 2006*, 2nd ed. New York: Wiley, 2006.

- [84] F. Grassi, Y. Yang, X. Wu, G. Spadacini, and P. A. Sergio, "On Mode Conversion in Geometrically Unbalanced Differential Lines and Its Analogy With Crosstalk," *IEEE Transactions on Electromagnetic Compatibility*, vol. 57, no. 2, 2015.
- [85] Fluke Networks, *Anwendungshinweis: Mode Conversion-Prüfung verhindert, dass Ihr Netzwerk in der Schwebe hängt*, 2019. [Online]. Available: <https://de.flukenetworks.com/content/application-note-mode-conversion-testing-prevents-your-network-hanging-balance> (visited on 01/17/2019).
- [86] Flavia Grassi, Fiordano Spadacini, Sergio A. Pignari, *The Concept of Weak Imbalance and Its Role in the Emissions and Immunity of Differential Lines*, Vol.55 No. 6. *IEEE Transactions on electromagnetic compatibility*, 2013, vol. Vol. 55 No.6.
- [87] R. G. Gallager, *Principles of digital communication*. Cambridge: Cambridge University Press, 2008.
- [88] ISO/IEC, *ISO/IEC TR 11801-9901 - Technical Report: Information technology - Generic cabling for customer premises - Part 9901: Guidance for balanced cabling in support of at least 40 Gbit/s data transmission*, ISO/IEC, Ed., Oct. 2014.
- [89] B. Janssen and M. Dettmer, "Data cable for high-speed data transmissions," WO2016012213A1, Jan. 28, 2016.
- [90] Reutlingen University, *Symmetrische Kupferverkabelung für Datenübertragung und Fernspeisung bis 3 GHz und 100 W : Schlussbericht : Laufzeit des Vorhabens: 01.11.2015-31.12.2017, Berichtszeitraum: 01.11.2015-31.12.2017*, Reutlingen, 2018.

References

- [91] William T. Clark, "Twisted pair cable having improved crosstalk isolation," US 2009/0071691 A1.
- [92] SSI Cable Corporation, *General Design Criteria: Attenuation(Insertion Loss)*, 2019. [Online]. Available: <https://www.ssicable.com/index.php/general-design-criteria/general-design-criteria-attenuation-insertion-loss> (visited on 05/29/2019).
- [93] Ken Gentile, "Digital Pulse Shaping filter Basics: Application Note," *Analog Devices*, 2007.
- [94] A. V. Oppenheim and G. C. Verghese, *Signals, systems & inference*, Global edition. Harlow: Pearson, 2017.
- [95] H. T. Saloni, Ravinder Kumar, and Vishal Verma, "Comparative analysis of BPSK, QPSK, QAM modulation and demodulation technique with bit error rate using MATLAB 2014a," *Journal of Advances in Computational Intelligence and Communication Technologies*, vol. 2, 2018.
- [96] Electronics Notes, *What is Bit Error Rate | BER Definition & Tutorial | Electronics Notes*, 2019. [Online]. Available: <https://www.electronics-notes.com/articles/radio/bit-error-rate-ber/what-is-ber-definition-tutorial.php> (visited on 07/10/2019).
- [97] Sharetechnote, *Quick Reference - Communication*, Shartechnote, Ed., 2019. [Online]. Available: https://www.sharetechnote.com/html/Handbook_Communication_BER.html (visited on 07/10/2019).
- [98] Keysight Technologies, "M8195A 65 GSa/s Arbitrary Waveform Generator M8197A Multi-Channel Synchronization Module: Data Sheet," Keysight Technologies, Tech. Rep., 2019.
- [99] —, "86100D DCA-X Wide Bandwidth Oscilloscope Mainframe and Modules: Data Sheet," Keysight Technologies, Tech. Rep., 2019.

References

- [100] R. Paschotta, *RP Photonics Encyclopedia - Bandwidth-distance product, bandwidth-length product*, 2019. [Online]. Available: https://www.rp-photonics.com/bandwidth_distance_product.html (visited on 05/28/2019).
- [101] W. Maichen, *Digital Timing Measurements: From Scopes and Probes to Timing and Jitter*. New York, NY: Springer US, 2006. [Online]. Available: <http://site.ebrary.com/lib/alltitles/docDetail.action?docID=10145177>.
- [102] A. Gumaste and T. Antony, *DWDM Network Designs and Engineering Solutions*. Indianapolis, IN: Cisco, 2002.
- [103] J. B. Anderson and A. Svensson, *Coded Modulation Systems*, ser. Information technology. New York: Kluwer Academic Publishers, 2003.
- [104] D. Behera, S. Varshney, S. Srivastava, and S. Tiwari, "Eye Diagram Basics: Reading and applying eye diagrams," edn.com, Tech. Rep., 2011. [Online]. Available: <https://www.edn.com/design/test-and-measurement/4389368/Eye-Diagram-Basics-Reading-and-applying-eye-diagrams> (visited on 10/09/2018).
- [105] ON Semiconductor, *AND9075 - Understanding Data Eye Diagram Methodology for Analyzing High Speed Digital Signals: Technical report*, 2015.
- [106] K. Feher, *Telecommunications measurements, analysis, and instrumentation*. Atlanta, GA: Noble Publishing, 1997.
- [107] D. R. Smith, *Digital transmission systems*, 3rd ed. Boston: Kluwer Academic Publishers, 2004.
- [108] Anritsu, "Understanding Eye Pattern Measurements - Application Note 11410-00533," Anritsu, Tech. Rep., 2010.

- [109] P. Tobin, *PSpice for digital communications engineering*, 1st ed. San Rafael, Calif.: Morgan & Claypool Publishers, 2007.
- [110] Keysight Technologies. (2014). Keysight Technologies Introduces DDR Bus Simulator to Solve the Bit-Error-Rate Contour Simulation Challenge, [Online]. Available: <https://about.keysight.com/en/newsroom/pr/2014/30sep-em14139.shtml> (visited on 10/04/2018).
- [111] F. S. Akkinuoye, H. Sasse, J. Walling, and A. Duffy, "Assessment of Bundle Heating due to Power Transmission over Ethernet cabling," in *International Wire & Cable Symposium - Proceedings of the 60th IWCS Conference*, vol. 60, 2011, pp. 146–153.
- [112] DKE, "ISO/IEC TS 29125:2016: Information technology — Telecommunications cabling requirements for remote powering of terminal equipment," DKE, Tech. Rep., 2016.
- [113] D. Schicketanz, A. Oehler, and K. Seitz, "Einfluss des Kabelverlegesystems auf das Temperaturprofil im Kabelbündel bei Fernspeisung - Bundle temperature profil as function of cable tray systems," in *Fachtagung Kommunikationskabelnetze*, vol. 24, Köln, Germany, 2017, pp. 60–66.
- [114] K. Seitz, H. Sari, A. Oehler, and Y. Engels, "Verhalten der Hochfrequenzübertragungseigenschaften von symmetrischen Kupferdatenkabeln in Abhängigkeit der Temperatur," *Horizonte*, vol. 50, pp. 11–15, 2017.
- [115] DKE, *DIN EN 50173-1:2011: Informationstechnik - Anwendungsneutrale Kommunikationskabelanlagen - Teil 1: Allgemeine Anforderungen (Deutsche Fassung EN 50173-1:2011)*, Frankfurt, 2011.
- [116] Agilent Technologies, "Agilent ENA 2, 3 and 4 Port RF Network Analyzers: E5070B 300 kHz to 3 GHz E5071B 300 kHz to 8.5 GHz E5091A Multiport

- Test Set E5092A Configurable Multiport Test Set Data Sheet,” Agilent Technologies, USA, Tech. Rep., 2008.
- [117] ISO/IEC, *Information technology — Generic cabling for customer premises — Part 1: General requirements*, 2016.
- [118] Tektronix, *Arbitrary Waveform Generators AWG70000A Series: Data Sheet*, Tektronix, Ed., 2016.
- [119] —, *Digital Serial Analyzer Sampling Oscilloscope: DSA8200 Data Sheet*, Tektronix, Ed., 2015.
- [120] K. Seitz, A. Oehler, and D. Schicketanz, “Wärmeentwicklung bei Fernspeisung bis 100 W,” in *ITG Fachtagung*, 2016.